

RAHIM HASANOV

SÚWRETLEW ÓNERI

1-KLASS USHÍN SABAQLÍQ

Qayta islengen ózbekshe 16-basılımlınan
qaraqalpaqsha on tórtinshi basılımlı

Ózbekstan Respublikası Xalıq bilimlendiriw ministrliǵı
baspáǵa usınǵan

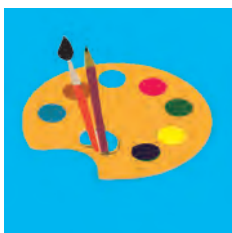

Ǵafur Ǵulom atındaǵı baspa-poligrafıyalıq dóretiwshilik úyi
Tashkent – 2018

UOK 741 (075)
KBK 74.268.51
H 12

Juwaplı redaktor:
Asqarali Sulaymonov — pedagogika ilimleriniń kandidatı.

Pikir bildiriwshiler:

R. Xudoyberganov — Kamoliddin Behzod atındaǵı Milliy súwretshilik hám dizayn instituti professorı;

G.Zulxaydarova — Respublika Bilimlendiriw orayı metodisti;

T. Mansurov — Tashkent wálayatı, Chinaz rayonındaǵı 40-mekteptiń muǵallımı.



– tapsırmalar.



– úyge tapsırma.



– sabaq tamamlandı.

**Respublika maqsetli kitap qorı qarjıları
esabınan basıp shıǵarıldı.**

Hasanov R.

Súwretlew óneri. 1-klass ushın sabaqlıq. Qayta islangen 14-basilımı. —
T.: Ğafur Ğulom atındıǵı baspa-poligrafiyalıq dóretiwshilik úyi, 2018. 56 b.

UOK 741 (075)
KBK 74.268.51

© Rahim Hasanov
© Ğafur Ğulom atındaǵı
baspa-poligrafiyalıq dóretiwshilik
úyi, 2018.
Qaraqalpaqshaǵa awdarma
© «Bilim» baspası, 2018.

ISBN 978-9943-5218-8-9

SÚWRETLEW ÓNERINIŇ TÚRLERI

Reňli sùwret



R. Xudayberganov. **Sijjakta.**



Laylo Salimjanova. **Hamro Rahimova.**



Baxtiyar Olimxanov. **Natyurmort.**

Músinshilik



R. Mirtojiev. **Mirza Ulu'bek.**

Grafika



Vladimir Parshin.
Sálem.



Bayram.



Qutluǵ Basharov. **Oqjaydan oq atıw.**

SÚWRETSHINIŇ JUMÍS QURALLARÍ

Qálem hám qılqálemler

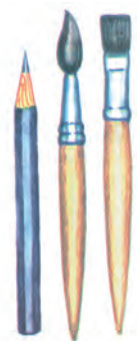

Akvarel boyawlar



Óshirgish

ReŇli qálemler

Suw idis



Palitra



Guash boyawlar

Jumis ornin shólkemlestiriw





SÍZÍQLAR HÁM FORMALAR



Bul súwretler formalardan quralğan.

Súwretler hám formalar



Dáp



Tórtmúyeshlik



Kvadrat



Úshmúyeshlik



Formalardıń atların aytıń.

Tolqin t rizli sızıqlar h m formalar

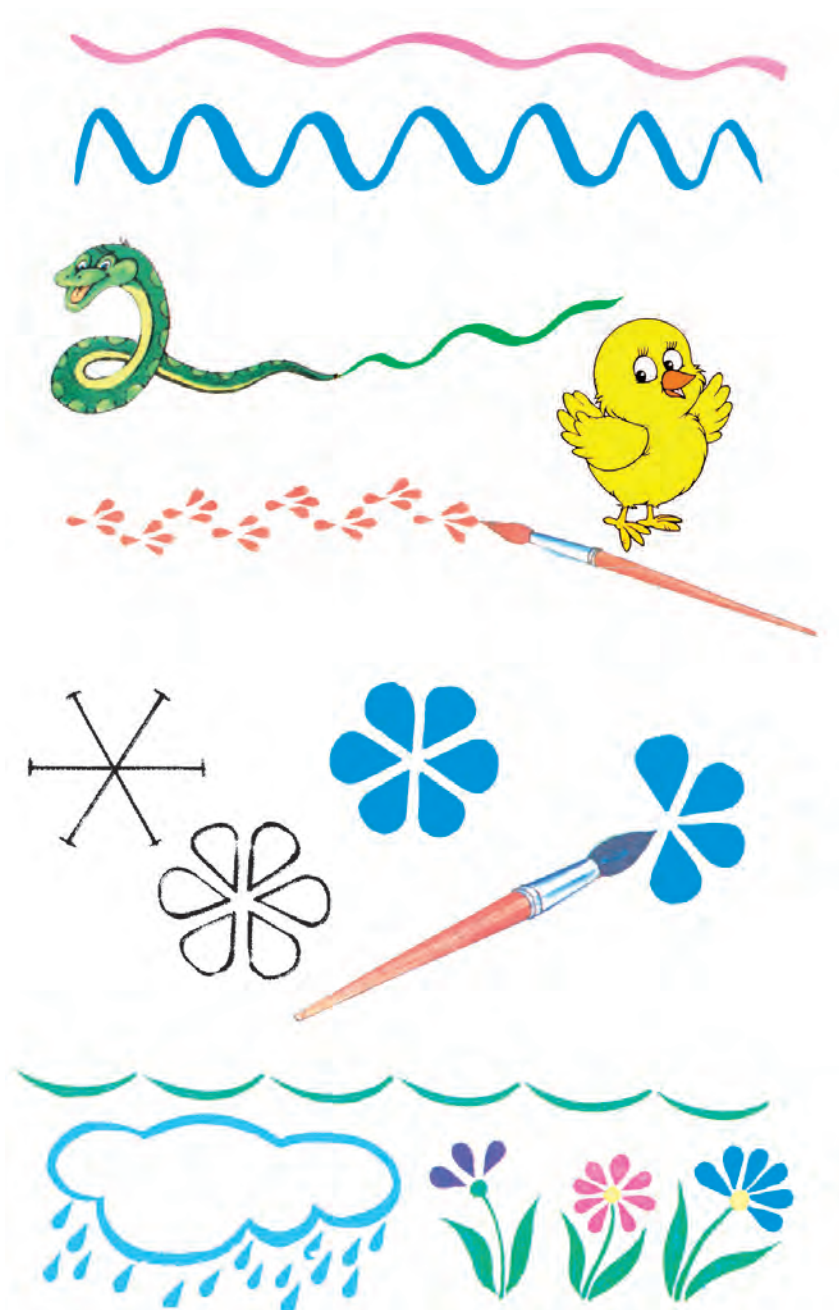

BOYAWLAR HÁM REÑLER

Akvarel hám guash boyawları



Reñler



Sarı



Aq



Qızıl



Qara



Sarǵısh



Kúlreñ



Kók



Qońır



Jasıl



Qızǵıshkók



Tiykarǵı reńler



Tiykarǵı reńlerden basqa reńlerdi
payda etiw



Jasıl



Sarǵısh



Qızǵıshkók



BAYRAQSHANÍŇ SÚWRETIN SALÍW

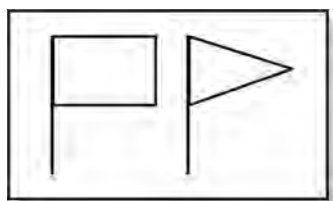

duris

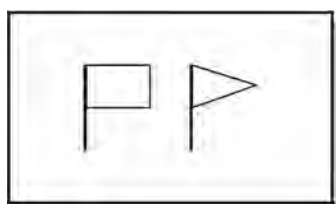

naduris

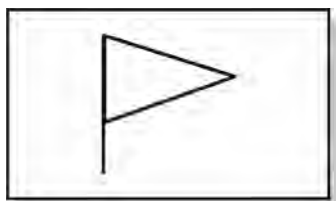

duris

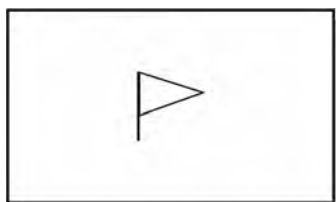

naduris

1

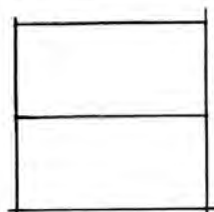

2

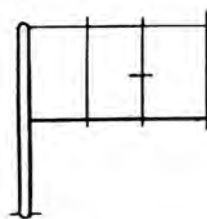

3

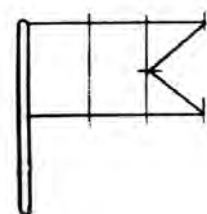

4



SAATTÍN SÚWRETIN SALÍW

Saatlar hár túrli formada boladı:



Saattín súwreti tómen degishe islenedi:

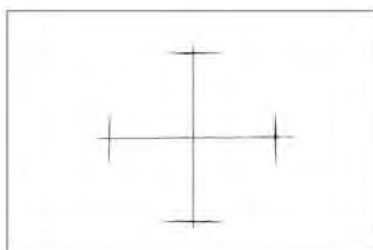

1

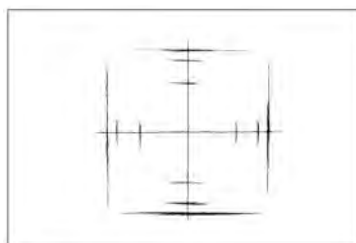

2

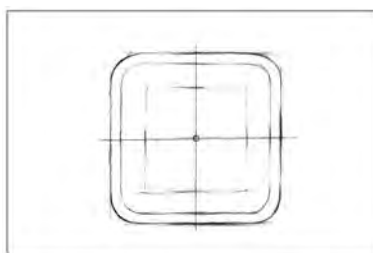

3

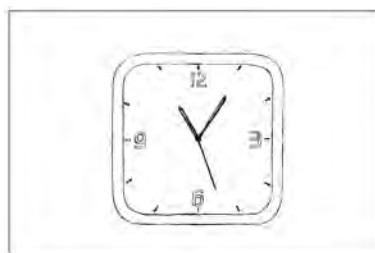

4



GÚZ MÁWSIMIN SÚWRETLEW



I. Haydarov. **Altın gúz.**



Abduvali Muminov. **Kórinis.**



V. Polenov. **Altın gúz.**

«GÚZ» TEMASÍNDÁ SÚWRET SALÍW



Erte gúz



Orta
gúz



Kesh gúz

Gúzde tábiyat hár qıylı
kóriniste boladı.



JAPÍRAQLARDÍŇ SÚWRETIN SALÍW



Japıraqlardıń formaları hám reńleri
hár qıylı boladı.

Japıraqtıń súwreti tómendegishe sızıladı:

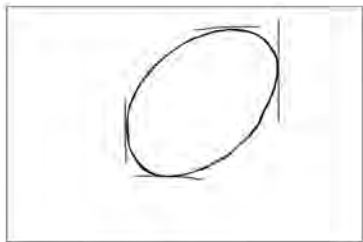

1

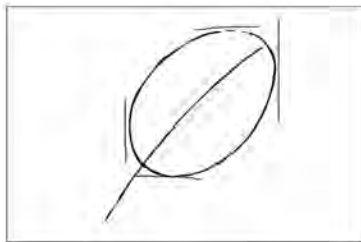

2



3



4

Japıraqtıń súwreti tómendegishe boyaladı:



1

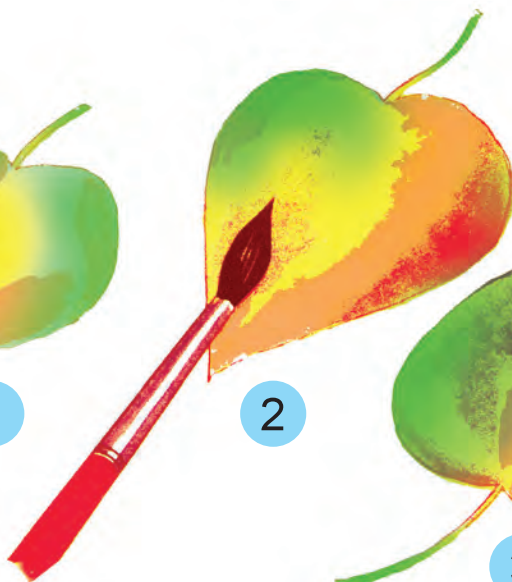

2



3



JAPÍRAQLARDAN SÚWRET HÁM FORMALAR ISLEW



Siz de joqarıdağılar sıyaqlı japıraqlardan bir jániwardıń kórinisin soğıń.

MÚSIN ISLEW

Steklar

Plastilin





Georgiy Ulko. **Usta Umarqul Juraqulov.**



Ustaniń jumislarınan úlgiler.



Ónermentshilik jumıslarınan úlgiler.

Oyınshıq músinler tómendegishe islenedi:



AKVARIUMDAĞÍ BALÍQLARDÍN SÚWRETIN SALÍW



Balıqlar dúzilisi hám reńi jaǵınan hár túrli boladı.

Balıqtıń súwreti tómendegishe salınadı:

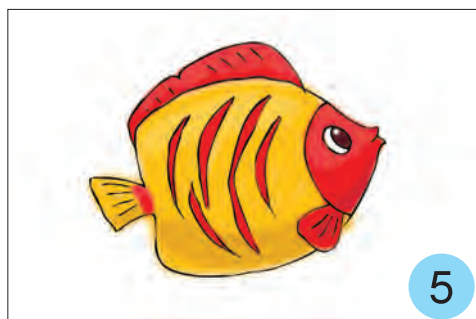
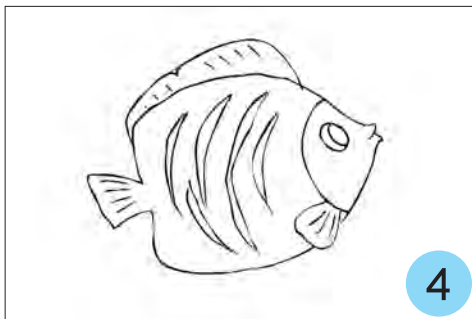
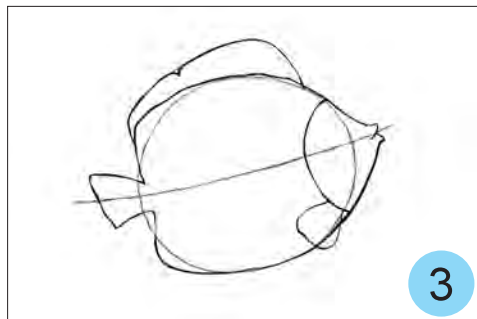
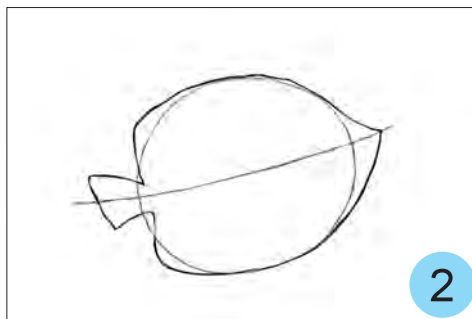
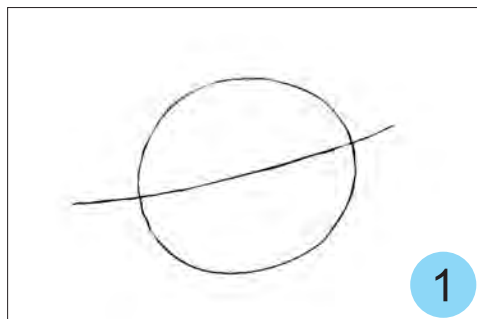

«EKI ESHKI» ERTEGI TIYKARÍNDÁ MÚSIN ISLEW



Eshki músini tómendegishe islenedi:

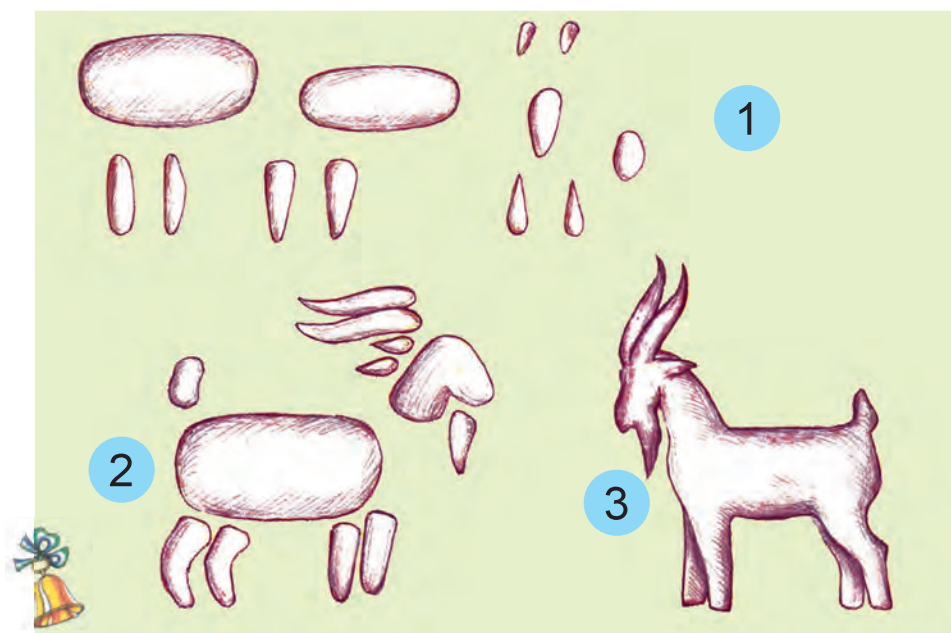

AVTOMASHINANÍŃ SÚWRETIN SALÍW



Mashinalardıń formasına hám reńine itibar beriń. Olar hár qıylı boladı, atların aytıń.

Avtomashinaniń súwreti tómendegishe
sızıladı hám boyladı:

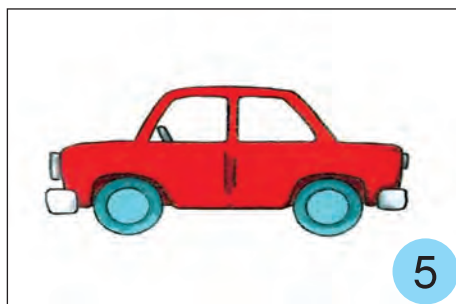
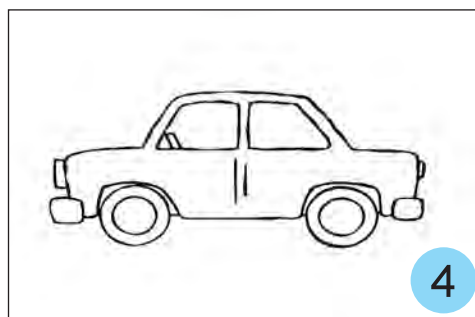
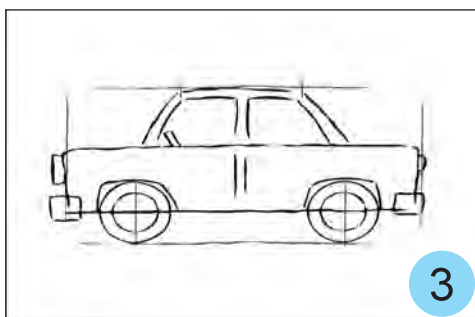
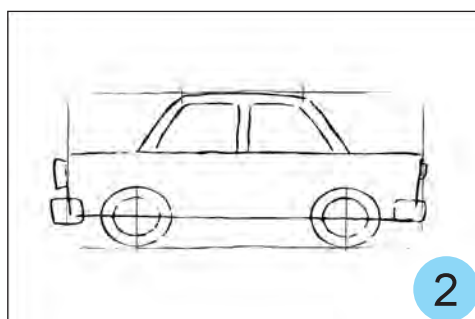
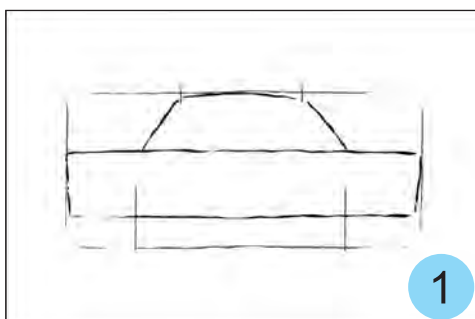

Endi avtomashina súwretin salıń.



Klasta baslağan isińizdi juw-
maǵına jetkeriń.



QÍS MÁWSIMIN SÚWRETLEW

Tómende qıs máwsimi súwretlengen.



I.I. Shishkin. **Qıs.**



Rustam Xudayberganov. **Qis.**

Joqarıdağı súwrette qis máwsimi súwretlengenligin qalay biliwge boladı?

Súwrette neler súwretlengen?

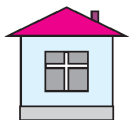

Qis kórinisin baqlañ.

«QIS» TEMASÍDA SÚWRET SALÍW



Kórgenlerińiz boyınsha qis kórisi súwretin salıń.



Klasta baslağan jumısıńızdı juwmaǵına jetkeriń.



GÚRRENIÍ MÚSININ ISLEW



Bul músinler ılaydan islengen.

Siz dáslep tayınshaqtıń músinin isle-
gensiz. Onı qalay islegen bolsańız gúr-
reniń músinin de solay isleysiz.

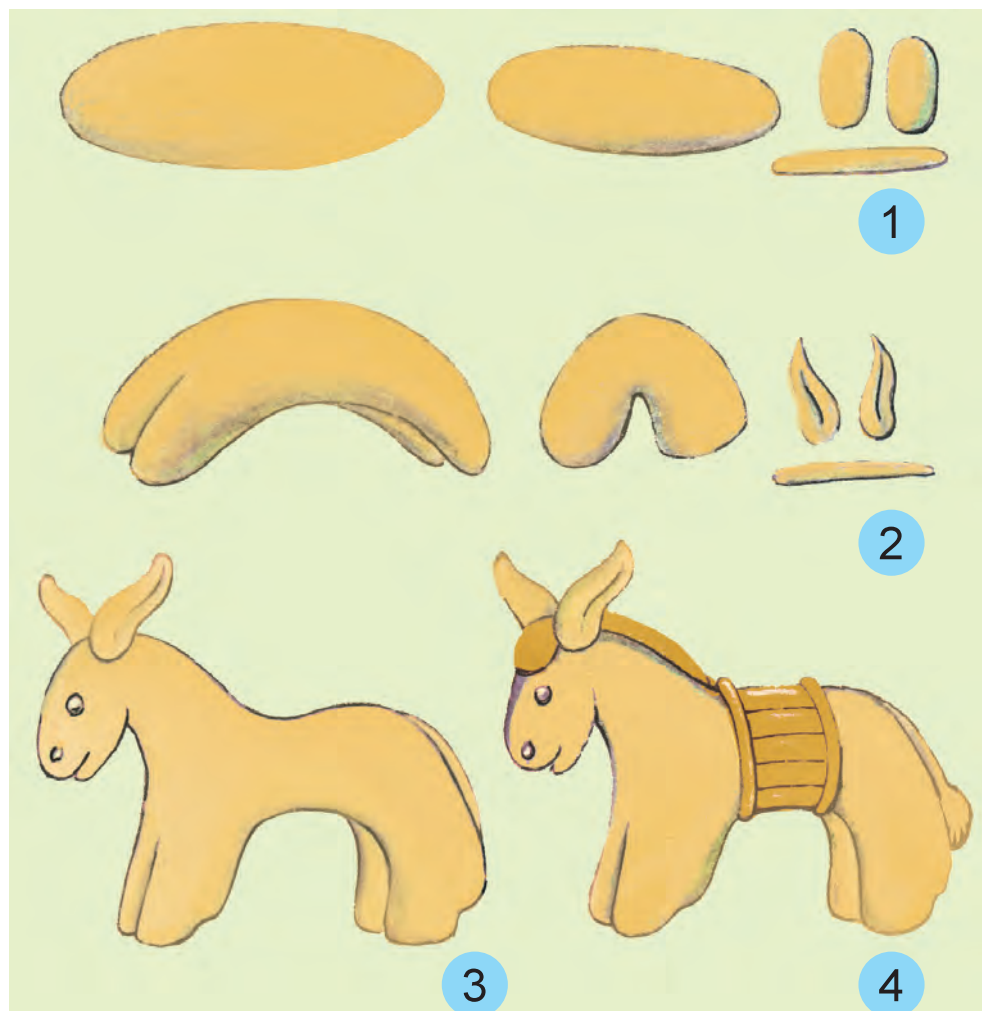

Gúrreniń músinin plastilin yama-
sa ılaydan islewge kirisin.

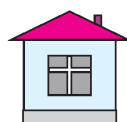

Klasta baslağan jumısıńızdı
juwmaǵına jetkerin.



JELQOMLÍ KEMENIŇ SÚWRETIN SALÍW

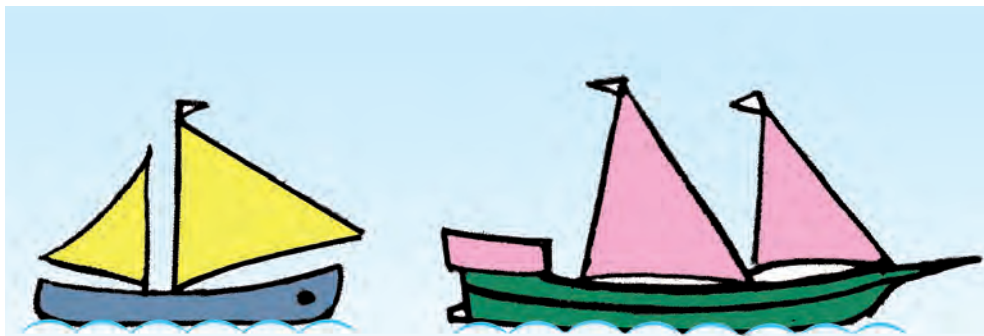

Jelqomlı kemeniń súwreti tómendegi tárıpte salınadı hám boyaladı.

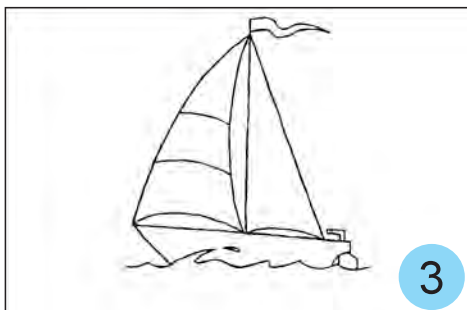
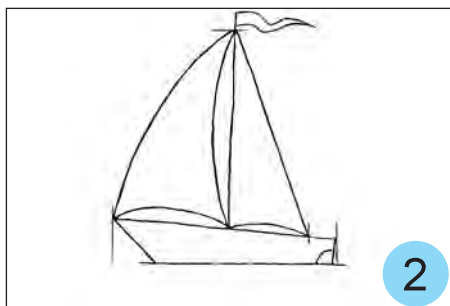
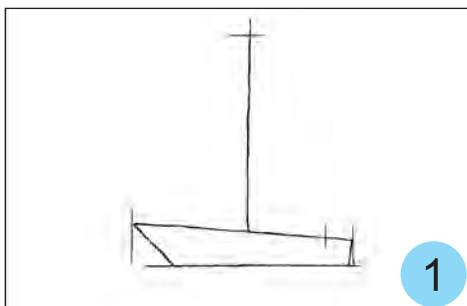

Sizler de jelqomlı kemeniń súwretin sizıń.

«ÚSH TÚLKI» ERTEGI TIYKARÍNDÁ SÚWRET SALÍW

Ertektiń mazmunı tómendegishe: Qasqa laqaplı qoyan eshegin minip, gúrresin ertip, toǵayǵa jol aladı. Dosları toǵayda hiyleker túlkiler barlıǵın aytıp, oǵan eskertedi. Qasqa olardıń gápine kirmeydi. Toǵayda ol dáslep ata túlkige gúrresin, soń ana túlkige eshegin urlatadı.



Aldanğan qoyan kól jaǵasında jılap otırǵan túlki balasına dus keledi hám onnan ne sebepten jılap atırǵanın soraydı.

Túlki balası shijlanı suwǵa túsip ketkenin, eger shijlandı suwdan alıp berse júz teńgesin oǵan beretuǵının aytadı. Qoyan júz teńgege eshek satıp alıwdı oylap kiyimlerin sheship suwǵa súńgiydi. Payttan paydalanğan túlki balası onıń kiyimlerin alıp ketedi.

Qoyan shijlandı taba almay suwdan shıqsa, kiyimleri joq. Úsh túlkige aldanǵanın sezgen qoyan toǵaylıqqa jalǵız bar-maytuǵın bolıptı.



Qoyan hám túlkiniń kórinisleri
tómendegi basqışlarda islenedi:

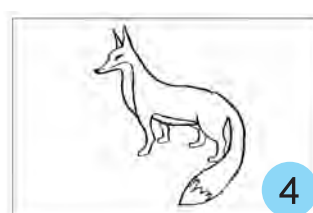
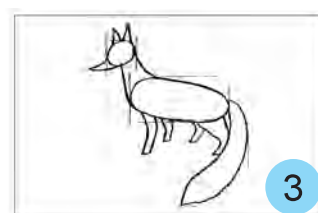
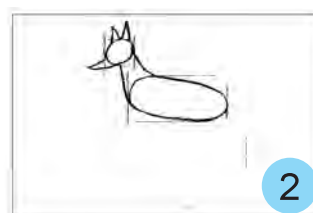
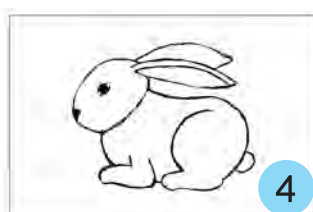
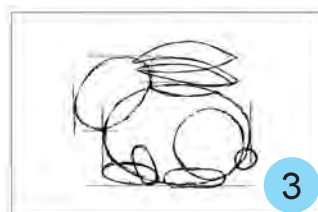
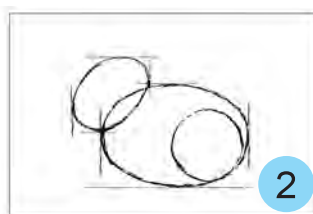
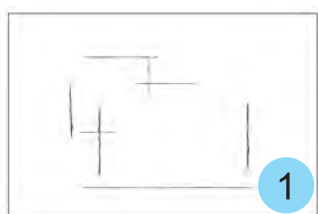

Ertek mazmunı tiykarında súw-
ret salıń.



Klasta baslaǵan jumısıńızdı
juwmaǵına jetkeriń.



PILDIŇ MÚSININ ISLEW

Siz dáslep hár qıylı músinler islegen ediňiz. Olardı qalay islegen bolsaňız, pildiň músinin de usı tártipte tómenдеgi basqışlarda isleysiz.

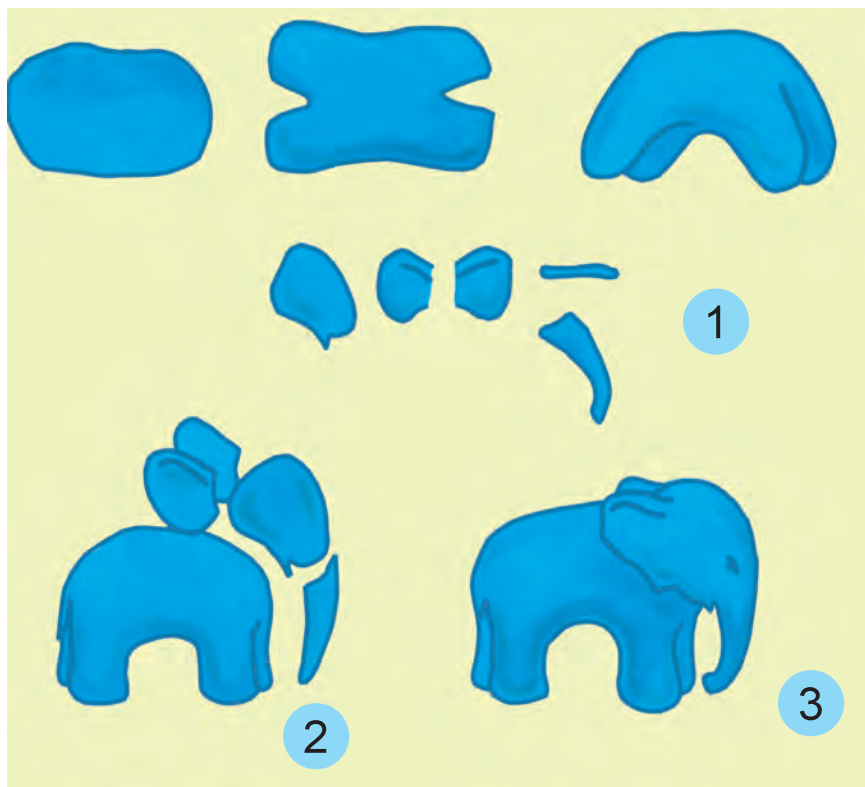

Pildiň músinin ılay yamasa plastilinnen isleň.



Basqa bir haywannıń músinin isleň.



SAMOLYOTTÍN SÚWRETIN SALÍW



Samolyotlar hár qıylı boladı.

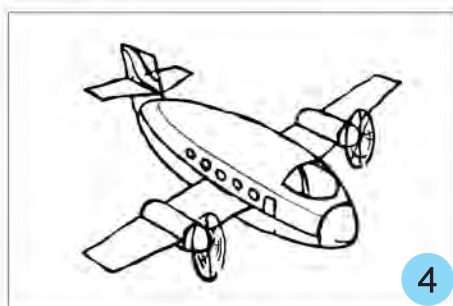
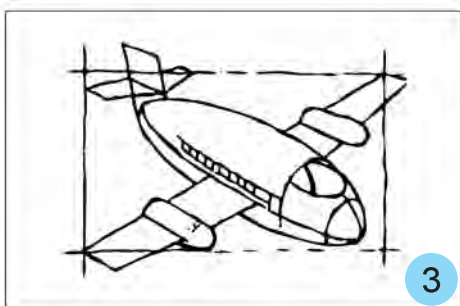
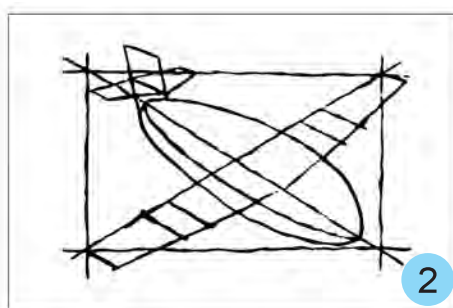
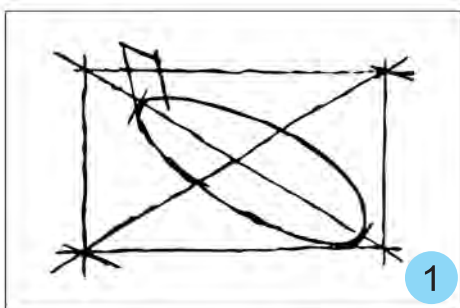

Samolyottiń súwretin joqarıda kórsetilgen sızılmalar boyınsha isleń.



Klasta baslağan jumısıńızdı juwmaǵına jetkeriń.



HAWA SHARÍNÍŇ SÚWRETIN SALÍW

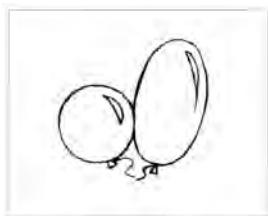
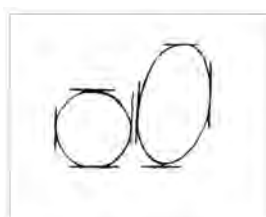
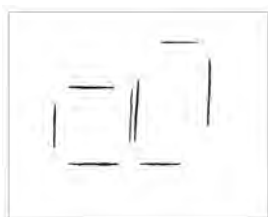

Joqarıdağı hawa sharlarınıń súwretin salıń hám boyañ.



Basqa formadağı hám reńdegi sharlardıń súwretin salıń.

BÁHÁR MÁWSIMIN SÚWRETLEW



Isaak Levitan. **Báhár.**



Rustam Xudayberganov. **Jawin aldinan.**



Báhár máwsimi kórinislerin
baqlań.



«ÚLKEMIZDE BÁHÁR» TEMASÍDA SÚWRET SALÍW



Rustam Xudayberganov. **Bağ ara báhár.**

Shıǵarmanı jaqsılap baqlań, bunda neler súwretlengenligin aytıp beriń.

Gúllep turǵan terektiń súwretin sızbaqshı bolsańız, tómenдеgi úlgilerge itibar beriń.

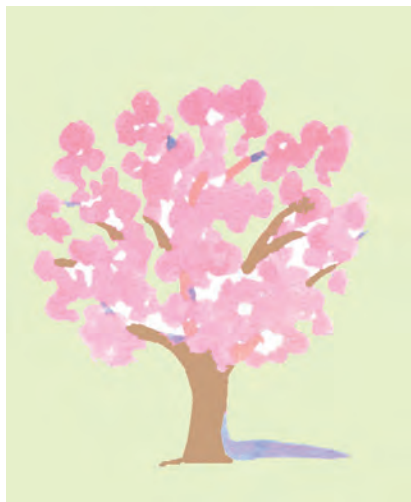

Dostińız salǵan súwret.
Gúllegen terektiń súwretin salıń.



Báhárgi tábiyat kórinisi tómenđegi basqishlarda sızladı:

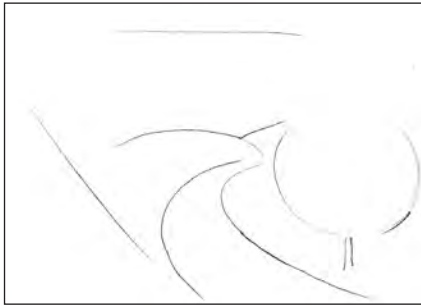

1

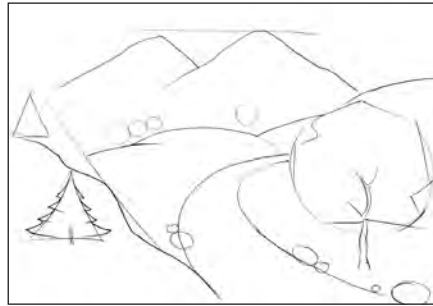

2

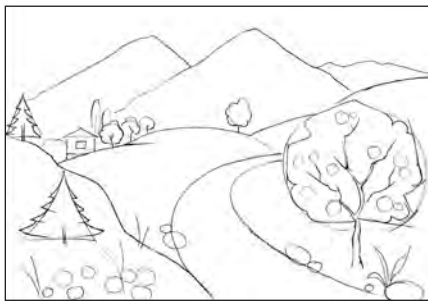

3

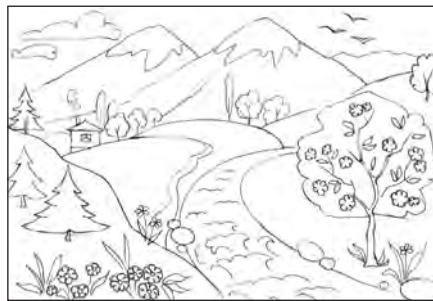

4



Báhárgi tábiyat kórinisi súwretin salıń.



Klasta islegen báhárgi tábiyat kórinisin dawam ettiriń hám boyañ.

GÜLLERDİN SÚWRETİN SALÍW

Báhárde ashılǵan gúller óz kórinisi hám reńi menen adamlardı ózine tartadı. Ásirese, biynápshe, lalagúl, sarıgúl, gúlsapsar, rozagúl sıyaqlı ráńbáreń gúller adamlardı tań qaldıradı.



Ǵafur Abdurahmanov.
Qızıl gernaygúlli natyurmort.



Laylo Salimjanova. **Güller.**



Dostınız salgan súwret.

Súwrette qanday güller hám neler súwretlengenligi hám de paydalanilgan reńler haqqında aytıp beriń.

Tómende berilgen sarigúldiń gúlin jaqsılap baqlań. Onıń boyı, gúli, jayıraǵınıń forması hám reńin anıqlań.



Sarigúldiń gúli tómendegishe salınadı:

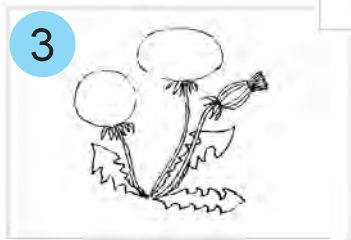
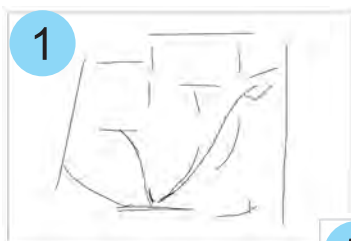

Sarigúldiń gúliniń súwretin salıń.



GÚBELEKTIŇ SÚWRETIN SALÍW

Siz hár túrli gúbeleklerdiŇ gúlden-gúlge qonıp ushıwın kóp kórgensiz. Gúbelekler úlken-kishi hám hár qıylı reńde boladı.



Gúbelektiń súwreti tómendegi basqıshlarda islenedi:

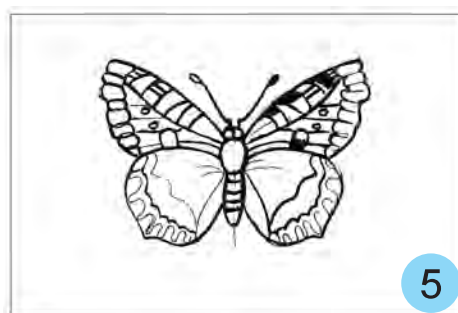
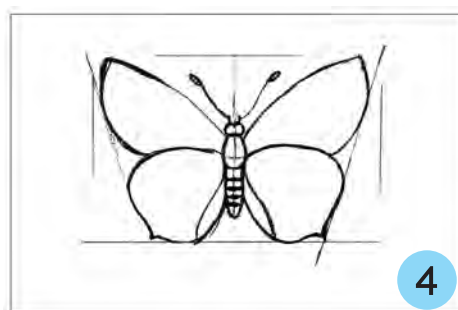
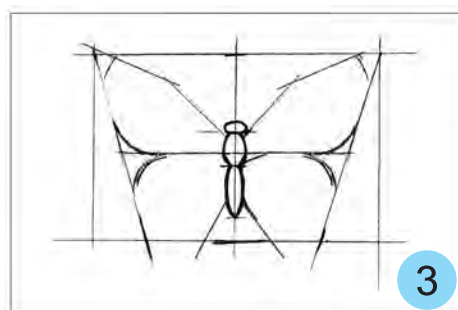
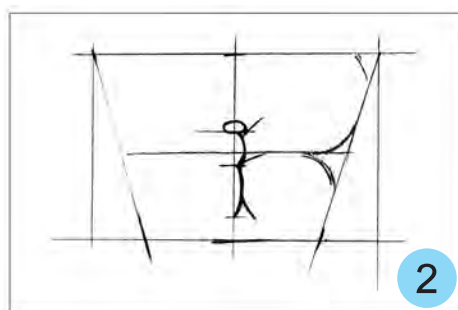
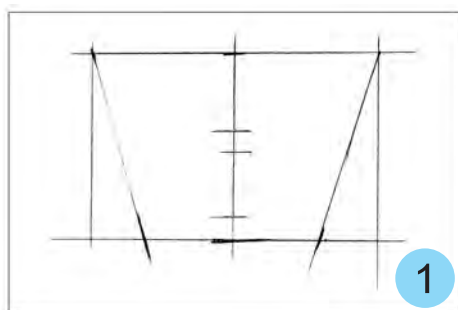

Gúbelektiń súwretin salıw basqısh-ların dıqqat penen baqlañ hám onıń súwretin salıń.



Ózińiz unatqan gúbelektiń súwretin salıń hám boyañ.



TOTÍQUSTÍN SÚWRETIN SALÍW

Totıquslardıń dúnyada júdá kóp túrleri bar. Olar úlken-kishi, hár qıylı reńde, júdá shıraylı boladı.

Súwrettegi totıquslardı jaqsılap kóriń, olardıń dúzilisi, forması, úlken-kishiligi, reńleri qanday ekenin aytıp beriń.



Endi súwret salıwǵa kirisseńiz boladı. Dáslep, totıqustıń súwretin qaǵazdıń qaysı jerine salatuǵınıńızdı hám onıń úlken-kishiligi qanday bolıwın belgilep alıń. Totıqustı qálegen reńge boyawıńız múmkin.

Totiqustıń súwreti tómenдеgi basqıshlarda salınadı.

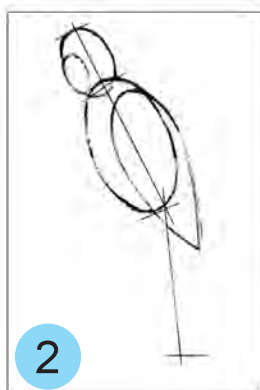

Siz de totiqustıń súwretin salıń.



1. Ózińiz bilgen basqa qustıń súwretin salıń hám boyañ.

2. Kelesi sabaqqa jil dawamında islegen eń jaqsı súwret hám músinlerińizdi kórgizbe ushın alıp keliń.



MAZMUNÍ

Súwretlew óneriniń túrleri.....	3
Súwretshiniń jumıs quralları.....	7
Sızıqlar hám formalar.....	10
Boyawlar hám reńler.....	13
Bayraqshaniń súwretin salıw.....	15
Saattıń súwretin salıw.....	16
Gúz máwsimin súwretlew.....	17
«Gúz» temasında súwret salıw.....	19
Japıraqlardıń súwretin salıw.....	20
Japıraqlardan súwret hám formalar islew.....	22
Músin islew.....	23
Akvariumdaǵı balıqlardıń súwretin salıw.....	26
«Eki eshki» ertegi tiykarında músin islew.....	28
Avtomashinaniń súwretin salıw.....	29
Qıs máwsimin súwretlew.....	31
«Qıs» temasında súwret salıw.....	33
Gúrreniń músinin islew.....	34
Jelqomlı kemeniń súwretin salıw.....	36
«Úsh túlki» ertegi tiykarında súwret salıw.....	37
Pildiń músinin islew.....	40
Samolyottıń súwretin salıw.....	41
Hawa sharınıń súwretin salıw.....	43
Báhár máwsimin súwretlew.....	44
«Úlkemizde báhár» temasında súwret salıw.....	45
Gúllerdiń súwretin salıw.....	48
Gúbelektiń súwretin salıw.....	51
Totıqustıń súwretin salıw.....	53

Rahim Hasanov
TASVIRIY SAN'AT

1-sinf uchun darslik

Qaraqalpaq tilinde

Qayta islangan ózbekshe 16-basilimınan
qaraqalpaqsha on tórtinshi basilımı

Awdarmashi *I. Serjanov*
Redaktori *U. Yusupova*
Tex.redaktori *B. Turımbetov*
Kompyuterde tayarlağan *A. Atagullaeva*

Basıwğa ruqsat etilgen waqti 15. 05. 2018-jil.
Formatı 70x100 $\frac{1}{16}$, Kegl 18 shponlı. «Pragmatika» garniturası.
Ofset usılında basıldı. 4,55 shártli baspa tabaq. 4,8 esap baspa
tabaq. Buyırtpa № 234. Nusqası 13121 dana.

Original-maket «Bilim» baspasında tayarlandı.
Ózbekstan Respublikası Ministrler Kabineti tárepinen
baspa xızmeti menen shuǵıllanıw ushın
2008-jil 15-iyulde AI №108 licenziyası berilgen.

«Bilim» baspası, 230103. Nókis qalası.
Qaraqalpaqstan kóshesi, 9.

Ózbekstan Baspasóz hám xabar agentliginiń Ğafur Ğulom atındaǵı baspa-
poligrafıyalıq dóretiwshilik úyinde basıp shıǵarıldı. 100128. Tashkent.
Labzak kóshesi, 86.

Bizning internet manzilimiz: www.gglit.uz
E-mail: info@gglit.uz