

I. A. Mannopova, R. A. Mavlonova,
N. R. Ibragimova

TEXNOLOGIYA

Uliwma orta bilim beriw mektepleriniń
4-klasi ushin sabaqlıq

Qayta islengen hám tolıqtırılğan
ekinshi basılımi

Ózbekistan Respublikası
Xalıq bilimlendiriw ministrliqi tárepinen
tastıyqlanğan

«Ózbekiston milliy ensiklopediyasi»

Mámleketlik ilimiy baspası

Tashkent — 2017

UO‘T: 37.035.3=512.121(075.2)

KBT 74.263ya71

M-81

Pikir bildiriwshiler:

- Z. Shamsiyeva** — Respublikaliq bilimlendiriw orayınıń bólim baslıǵı;
M. Pulatova — Tashkent qalasındaǵı 144-sanlı ulıwma orta bilim beriw mektebiniń texnologiya muǵallimi;
D. Karimova — Buxara qalasındaǵı 18-sanlı ulıwma orta bilim beriw mektebiniń texnologiya muǵallimi.

SHÁRTLÍ BELGILER:



– abaylı bolıń;



– toparda islew;



– óz betinshe jumıs;



– tákirarlaw;



– soraw hám tapsırmalar;



– este tutıń

Mannopova I.

M-81

Texnologiya: 4-klass ushın sabaqlıq / I. Mannopova, R. Mavlonova, N. Ibragimova. – Tashkent: «O‘zbekiston milliy ensiklopediyasi» Mámleketlik ilimiy baspası, 2017. –112 bet.

UO‘T: 37.035.3=512.121(075.2)

KBT 74.263ya71

Respublika maqsetli kitap qorı qarjıları esabınan basıp shıǵarıldı.

ISBN 978-9943-07-480-4

- © **I. Mannopova hám b.**, 2015, 2017.
© «**O‘zbekiston milliy ensiklopediyasi**» Mámleketlik ilimiy baspası, 2015, 2017.
Qaraqalpaqsha awdarma
© «**Bilim**» baspası, 2017.

KIRISIW

Húrmetli oqıwshı!

Sizler «Texnologiya» sabaqlığı járdeminde tómen-gi klaslarda alǵan bilim, kónlikpe hám tájiriybelerdi bekkemlegen jaǵdayda hár túrli materiallardan jáne de shıraylı buyımlar, oyınshıqlar, modeller islew texnologiyasını úyrenesiz, ónerment ustalardıń buyım islew usılları menen tanısasız.

Sabaqlıqta berilgen tapsırmalardı orınlaw nátiyjesinde maǵlıwmatlardı izlew, orınlaw, tártibin eslew, xabarlardan paydalanıw, óz ara klaslaslar hám jası úlkenler menen qatnas jasaw hám bir-birińizge járdem beriw, kelisip islewdi úyrenesiz.

Sabaqlıq sizlerge sulıw buyımlar hám shıraylı sawǵalardı óz betinshe islewde jaqınnan járdem beredi. Olardı ata-anańız, úkelerińiz, doslarıńızǵa sawǵa etseńiz quwanadı.

Sabaqlıqta jumıs orınlaw tártibi hám onıń basqıshları bayan etilgen. Berilgen úlgilerdi kórip shıǵır, súwret hám sızılmalardı úyreniń, orınlaw barısında tómenдеgi sorawlarǵa juwap beriwe háraket etiń.



1. Buyımńıń atın hám onıń qayjerde isletiliwin aytır.
2. Buyımlar qanday materiallardan islengen?

3. Usı materialdı basqa buyım islewde isletiw múmkin be?
4. Buyım bóleklerin qalay belgilew múmkin?
5. Buyım bóleklerin tayar buyımnan qalay ajiratıw múmkin?
6. Buyımlarğa forma beriw múmkin be? Qalay?
7. Buyımlardı qanday jollar menen biriktiriw múmkin?
8. Qosımsha bezew talap etildi me? Qalay? Qalay orınlaw múmkin?

Átirapımızdağı texnologiyalıq process

Áyyemgi zamanlardan-aq insanlar kúndelikli turmısında hár qıylı buyımlardan paydalanğan. Insan áste-aqırın suw saqlawda paydalanatuğın gúzelerge, bólmeni jaqtılandırıw ushın kerek bolğan sham qoyğışlarğa, awqatlanıw ushın kerek bolğan kese-tabaqlarğa bezew bergen. Dáslep, qolaysız idis-tabaq, gúze hám úlken gúzeler islengen bolsa, keyin ala buyımlar názik, jeńil, shıraylı hám sulıw formalarğa keltirilgen. Sońğı júz jil ishinde insanlardıń kúndelikli miynetin jeńillestiriwshi júdá kóp kúndelikli xızmet kórsetiw-texnikalıq ásbaplar dúziliwine ózgeris kirgizildi. Bul kirgizilgen ózgerisler texnologiyalıq procesler arqalı ámelge asırıldı.

Texnologiya (grekshe, **techne** — sheberlik, kórkem óner, **logos** — táliymat) — shiyki zat hám materiallarğa tiyisli óndiris quralları járdeminde islew beriw jolları haqqındağı pán.

Buyımlar islew texnologiyası tómenдеgi bes basqıshpa-basqısh orınlaw procesinde ámelge asırıladi.

Birinshi basqıshqa ideya dep aytiladi. Bunda qanday buyım islew kerekligi sheshiledi.

Ekinshi basqıshta buyımdı islew rejesi islep shıǵıladi. Buyım bólimleriniń sızılması tayarlanadi.

Úshinshi basqıshta buyım kórinisi sızıladi. Buyımdı qanday usıllarda islew oylap kóriledi, joybarı sızıladi. Kerekli materiallar tańlanadi.

Tórtinshi basqıshta buyım tayarlanadi hám bezeledi.

Besinshi basqıshta buyımǵa sıpatına qarap baha beriledi.

Texnologiyada hárbir process úsh basqısh: tayarlanıw, tiykarǵı hám juwmaqlawlarına bólinedi.

Tayarlanıw basqıshında: jumıs ornı, kerekli material hám ásbaplar tayarlanadi.

Tiykarǵı basqısh ta jumıs orınlanadi.

Juwmaqlaw basqıshında jumıs ornı jıynastırıladi hám jumıs nátiyjesi bahalanadi.

Máselen, anańız ushın estelik sawǵa tayarlaw maqsız. Bunıń ushın sawǵa tayarlaw texnologiyasını islep shıǵıwıńız kerek.

Birinshi basqısh — qanday sawǵa tayarlaw ushın tómenдеgi sorawlarǵa juwap tabıwıńız kerek.



Qanday buyımlar islewdi bilesiz? Islew ushın kerekli ásbap hám materiallar bar ma? Bul material hám ásbaplardan qanday buyımlar islew múmkin? Ne islew múmkin emes? Sebep nede?



Ekinshi basqısh — qutlıqlaw sawǵasın islew rejesin dúzip shıǵasız.

Bunıń ushın ayrıqsha qutlıqlaw sawǵasın islewdi oylap alıń. Berilgen súwretler sizge qutlıqlaw sawǵasın islewde jol kórsetedi. Qaysı súwret unanǵan bolsa sonı tańlap alıń yamasa ózińiz oylap tabıń.

Úshinshi basqısh — qutlıqlaw sawǵasın izbeizikte tayarlaw rejesin dúzip shıǵıń. Súwrette durıs orınlaw tártibin kórsetiń. Qutlıqlaw sawǵasın islew procesi tártibin oqıń. Ózińiz orınlaǵan jumıs penen salıstırıń.

1. Qutlıqlaw sawǵasınıń negizin tayarlań.
2. Applikaciya ushın gúllerdi qıyır.
3. Úlken bólegine jabıstırır.
4. Mayda bóleklerin jabıstırır.

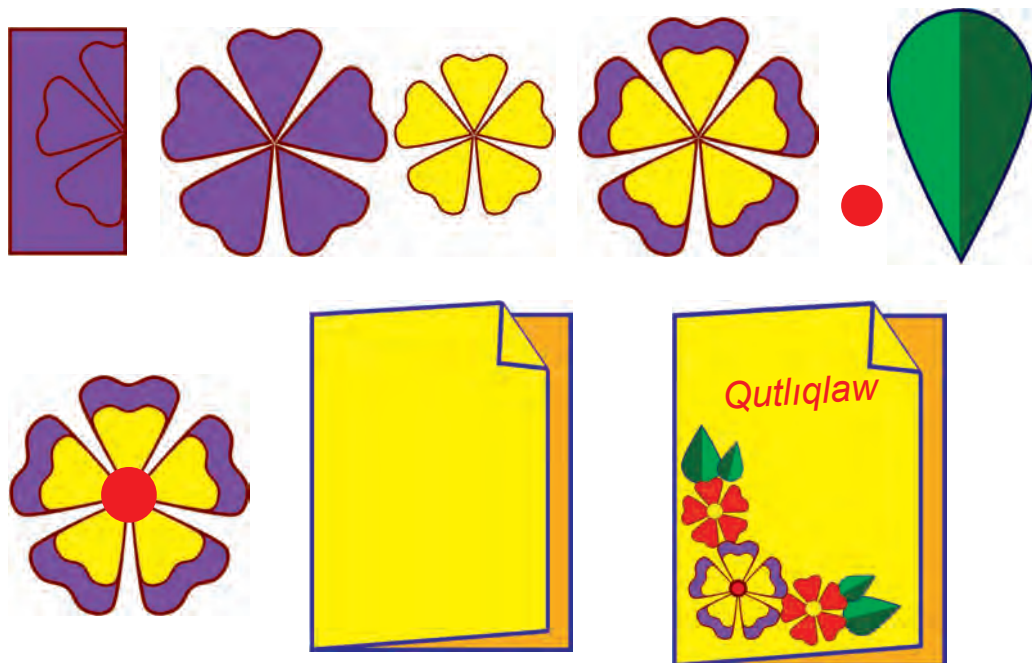

Tórtinshi basqış — kerekli material hám ásbaplardı tańlań. Jumıs ornın tayarlań. Ózińiz dúzgen reje boyınsha qutlıqlaw sawǵasın tayarlań. Jumıs ornıńızdı jıynastırıp qoyır.

Besinshi basqış — orınlangan jumısqa baha berir. Qutlıqlaw sawǵasın alıp kórip shıǵır. Sizge unadıma? Applikaciya ushın tayarlangan formalar durıs, tegis qıyılǵan ba? Durıs jabıstırılǵan ba? Doslarıńızǵa kórsetir hám birgelikte bahalań.



ÁSBAP HÁM JUMÍS QURALLARÍ

Súwrette qanday ásbap hám jumís qural-
lar súwretlengen? Olar qalay ataladı hám ne
maqsette isletiledi? Qaysı ásbap sizge tanıs emes?



MATERIALLAR

Bul oqıw jılında sizge texnologiya sabaqlıǵında
shuǵıllanıw ushın tómenдеgi materiallar kerek bo-
ladı. Olardan ayırımları sizge tómengei klaslardan
baslap jaqsı tanıs. Bul jerde siz birinshi ret kórip
turǵan materialdı aytıń hám miynet qáwipsizligi
qaǵıydalarına ámel etiń.





Jumıs procesinde qáwipsizlik qaǵıydarına ámel etiń!

- 1) jumıs ornın durıs shólkemlestiriń;
- 2) jumıs ornın taza hám tártipli saqlań;
- 3) muǵallimdi dıqqat penen tırılań hám kórsetpelerin orınlań;
- 4) ásbaplardan muǵallım kórsetkenindey paydalanıń;
- 5) ásbaplardan tek belgilengen jumıs procesinde paydalanıń;
- 6) biz hám qayshını qol menen uslaytuǵın tárepinen, cirkuldi bolsa bas tárepi menen beriń;
- 7) shanslılatuǵın ásbaplarıdı ayrıqsha qapta saqlań;
- 8) jumıs waqtında biyparıq bolmań, dostıńızǵa kesent bermeń.



Bilimińizdi sınap kóriń

1. Qayshını birewge bergende qalay beriw kerek?

- a) uslaǵısh tárepi menen;
- b) uslaǵısh tárepin ózińizge qaratıp;
- d) ayaq astına taslaw kerek;
- e) ashıq jaǵdayında.







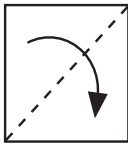

2. Kley menen islep bolǵannan keyin, qıl qálemdi ne qılıw kerek?

- a) suw menen juwıw;
- b) suw menen sabınlap juwıw;
- d) taslap jiberiw;
- e) keptiriw.

QAĞAZDÍ BÚKLEW USÍLLARÍ

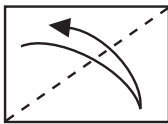
Origami — qağazdı búklew jolı menen hár túrli figuralar islew óneri. Islengen figuralardı óz ornına jaylastırw arqalı hár túrli kórinislerdi payda etiw múmkin. Bunıń ushın arawlı belgilerdi bilip alıwıńız kerek. Bul belgiler menen tanısıń, eslep qalıń hám de islewge háreket etiń.

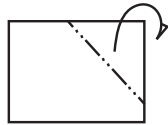
SÍZIQ HÁM KÓRSETKISHLER

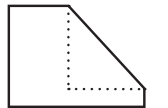
Kórinis	Shártli belgiler	Mısallar
	Sızıq tóbesi bólimindegi múyeshti ózińiz tárepke búklew kerekligin bildiredi.	
	Bul sızıq bolsa qağazdıń joqarǵı bólimin tómenge qarap búklew kerekligin ańlatadı.	
	Bul sızıqlı kórsetkish qağazdı eki búklegennen keyin, sol jerdi tuwrılaw hám usı bóleginde sızıq payda etiw kerek degen sóz.	
	Bul tuwrı sızıq búklegen jerde sızıq payda bolǵanlıǵın bildiredi.	
	Eń sońǵı shártli belgi bolsa kózge kórinbeytuǵın sızıq bolıp esaplanadı.	

Anıqlawshı belgiler



Noqatlardı bir-birine baylanıstırw kerekligin ańlatadı.



Arasın ashıw kerekligin bildiredi.

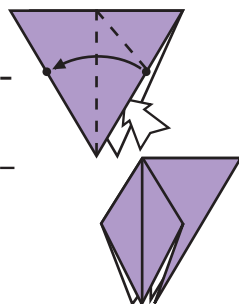

Figuralar menen islew



Figuranı 180° gradusqa aylandırw kerek ekenligin bildiredi.

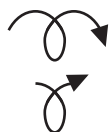

Figuranı arqa tárepke burıw kerekligin anıqlap beredi.

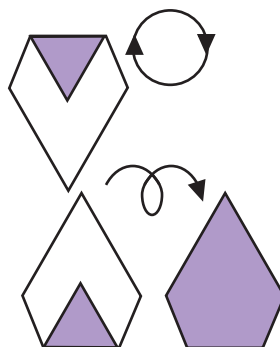

Birgelikte ámelge asırılatsuǵın jumıslar



Qabat-qabat etip búklew.



Orınlanıp atırǵan isti bir-neshe ret tákirarlaw.



Oraw.



Birneshe márte taqlap oraw.

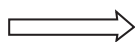

Alıw, ashıw, burap shıǵarıw hám jayıw.



Bir-biriniń ishine kirgiziw.

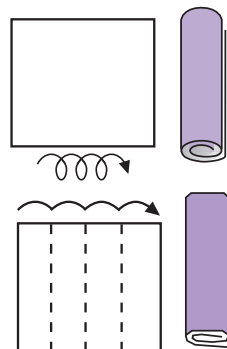
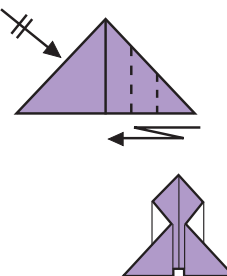



KÚSHIK ISLEW

Kúshik islewde origami usılınan paydalanıń.
Belgilerge itibar beriń.

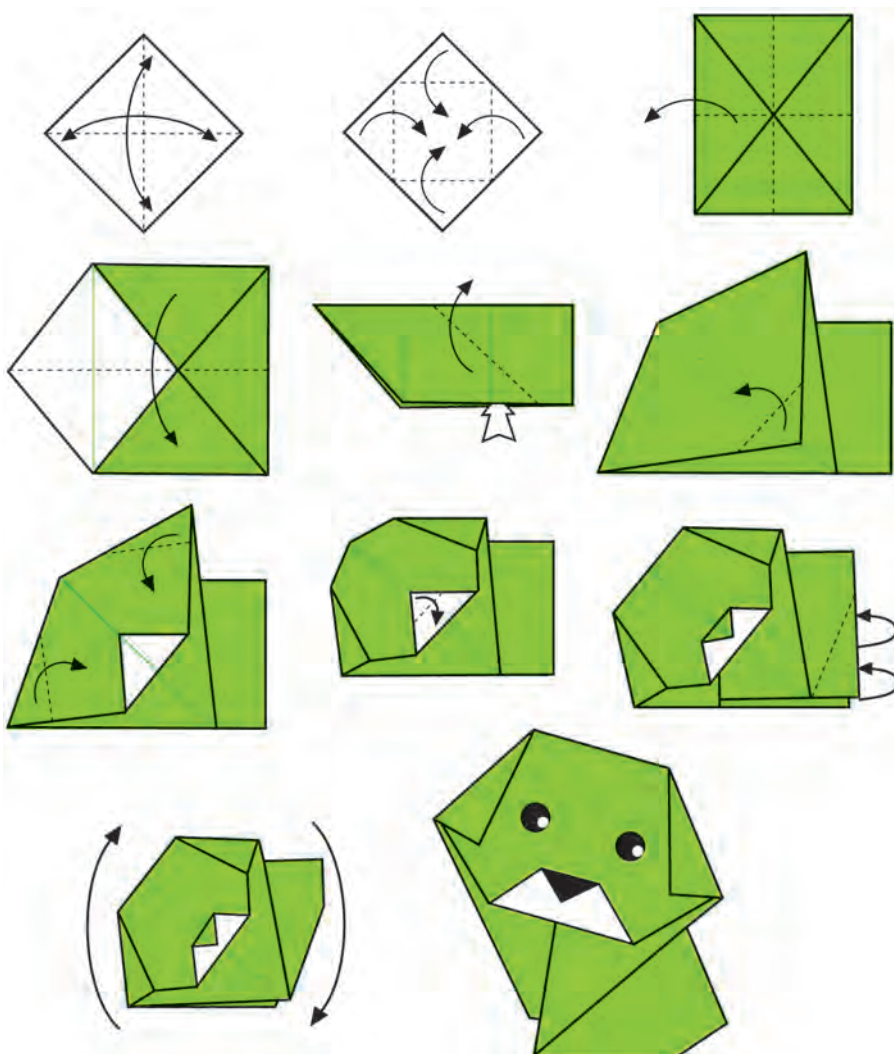

Tapsırma. Kinolog kásibi haqqında maǵlıwmat toplań.



Tapsırma (óz betinshe ornlaw ushın). Súwretke dıqqat penen qarań hám qoraz figura-sın isleń.

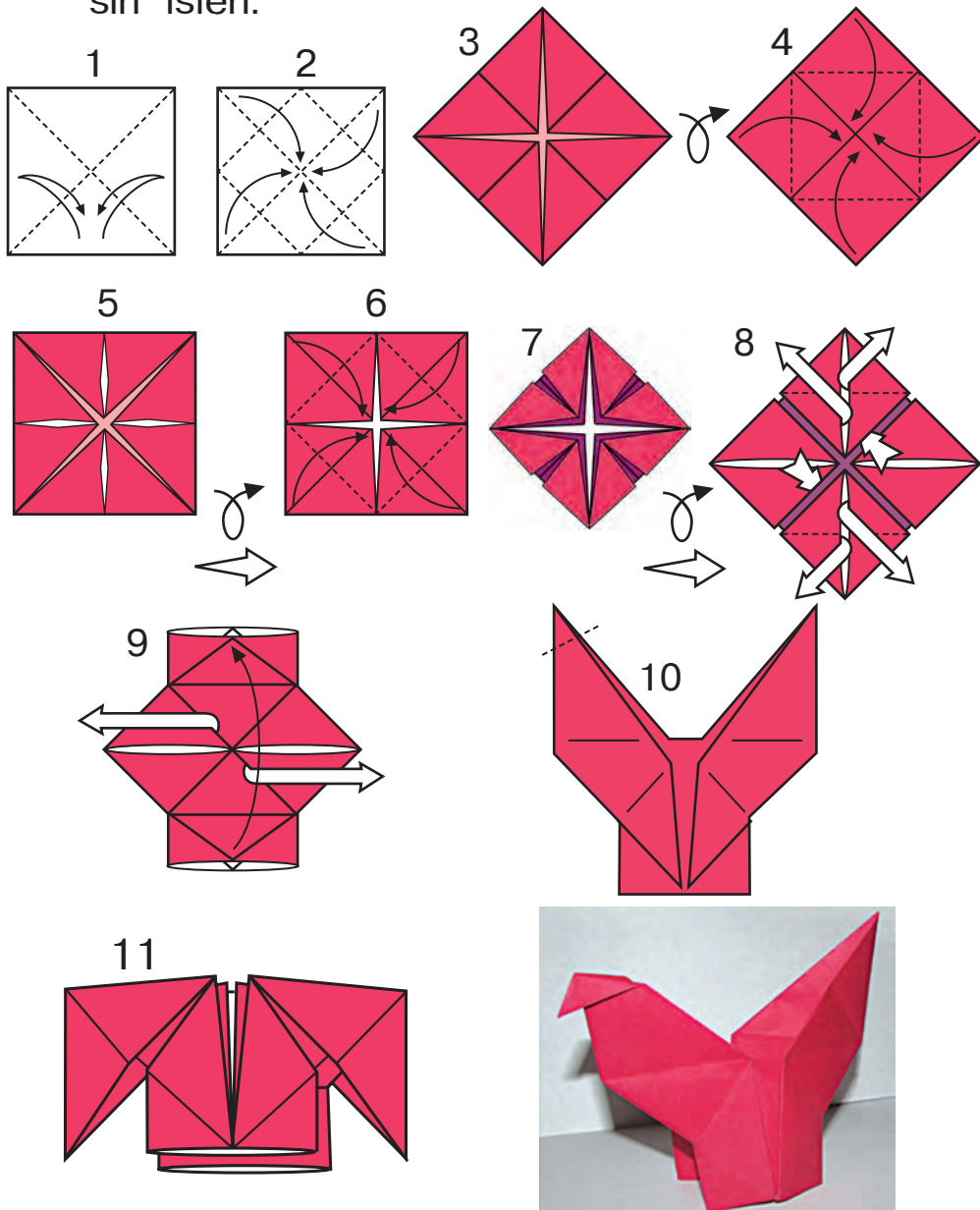

QAĞAZDAN SPORT AVTOMOBIL MODELIN ISLEW



Tuwrı tórtmúyesh qağazdı uzınına ekige búklep, joqarı tárepiniń ushın tómenge qaratıp búkleybiz hám ashamız. Tómengi tárepiniń ushı menen de tap usı procesti tákirarlaymız.

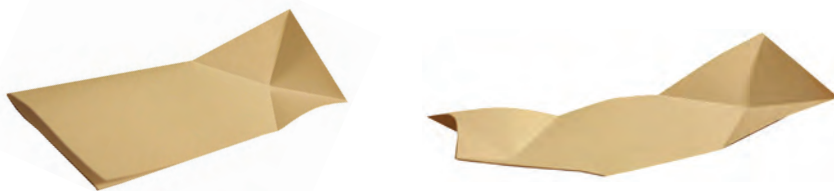

Nátiyjede búklengen jerde sıziqlardıń izi payda boladı. Usı procesti ekinshi tárep penen de orınlaymız.



Búklengen sıziq izlerinen qaptal tárepin orayǵa qarap súwrette kórsetilgendey búkleybiz. Ekinshi tárepin de usılay búkleybiz. Nátiyjede oq atıwshı mergenge uqsaytuǵın forma payda boladı.



Payda bolǵan mergen formasın joǵarıda kórsetip, onıń qaptal táreplerin ishke qaratıp búkleybiz. Sonda sizde súwrette kórsetilgendeı forma payda bolıwı kerek.



Tayarlanǵan modelimizdiń bir tárepin alıp, onnan mashinanıń aldınǵı tárepin isleybiz. Buniń ushin payda bolǵan birinshi mergenniń eki tárepin súwrette kórsetilgendeı ortaǵa qarap búkleybiz.



Ekinshi payda bolǵan mergenimizdi súwretke qarap ortasınan búkleybiz.

Birinshi mergenimizge ekinshi mergenimizdiń ushların jaylastıramız. Endi arqa tárepin súwrette kórsetilgendeı búkleybiz.

TÁBIYIY MATERIALLARDAN APPLIKACIYA USÍLÍNDÁ GÚL ISLEW

Dóretiwshilik penen shuǵıllanıw ushın tábiyat bizge hár túrli materiallardı inam etken. Olar hár qıylı formada bolıp ǵana qalmaq, tábiyattıń ózi bizge olardan neler islew kerekligin de kórsetip turadı. Qarań, tómendegi súwretlerde qanday tábiyiy materiallardan paydalanılǵan?



Sizge islengen qaysı zat kóbirek unadı? Siz ózińiz de sonday zattı islewińiz múmkin. Bunıń ushın kerekli materiallardı tayarlap alıń. Tábiyiy materiallar qalay tayarlanadı? Eslep kóriń.

Gúl islew ushın orınlanatuǵın jumıslar izbe-izligin belgilep alıń hám jumıstı baslań.

Qawın, qabaq, ǵarbiz hám de miywe tuqımları tábiyiy zatlarǵa kiredi. Gúl islew ushın Sizge, sonday-aq, qaǵaz benen qayshı, kley, plastilin, hár qıylı tereklerdiń japıraqları, guash boyawı qılqálem kerek boladı.



Súwrette kórsetilgenindey, qaǵazdan diametri 2 sm li sheńber qıyp alıń hám oǵan 5 shabdal shańgalaǵın jabıstırıń.

Usılay tayarlanǵan eki formalı qaǵazdı bir-birine jabıstırıń.



Eki tárepinen ortasına 3 den shabdal shańgalaǵın jabıstırń. Kepkennen keyin guash penen boyañ.

Gúl japıraǵı ushın shabdal shańgalaqların jasıl reńge boyañ hám gúl átirapına jaylastırń.

Kórip turǵanıńızday, shańgalaqlardan hár qıylı gúllerdi islew múmkin.



ÓZ BETINSHE DÓRETIWSHILIK JUMÍS

Sizge kerek boladı: qawın, qabaq, ǵarbız tuqımları hám xurma shańgalaǵı; qaǵaz benen qayshı, kley yaki plastilin; hár qıylı terek japıraqları.



GÚL ISLEW

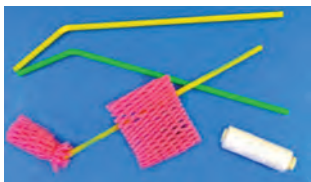

Bizge ashıq qızıl hám aq reńdegi miywelerdi salıwǵa isletiletuǵın tor qalta, ishimlik ishiwge arnalǵan trubkalar kerek boladı.

Ashıq qızıl reńdegi tor qaltanı eki búklep qıyamız hám birewin trubkanıń ushına orap, jip penen baylaymız.

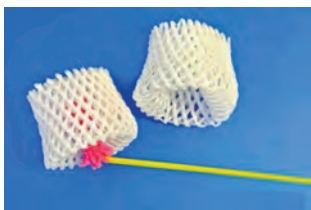
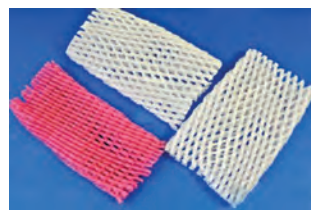

Aq reńdegi tor qaltanı eki búkleymiz, ishine ashıq qızıl reńli gúl ortasın jaylastıramız hám jip penen baylaymız.

Usılayınsha basqa gúllerdi de tayarlaymız.

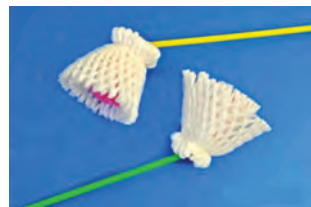

Qalıń kartonnan japıraq qıyıp alamız.

Gúldáste tayarlaymız.





GÚZGI JAPÍRAQLARDAN GÚL ISLEW

1



2



3



4



5



6



7



ASXANA BUYÍMLARÍ MENEN TANÍSTÍRÍW HÁM ISLEW

Súwrette qaysı kásip iyesi súwretlengen? Ol jámiyetke qanday payda keltiredi? Jumıs babında qanday ásbaplardan paydalanadı?

Súwrette kórsetilgen buyımlarǵa itibar beriń. Qaysı qatardaǵı buyımlar ásxana buyımları, qaysı qatardaǵı buyımlar asxanada paydalanılatuǵın ásbaplar hám qaysıları turmıslıq xızmet kórsetiw texnikalar taypasına kiredi? Olardıń atların hám olardan qanday jaǵdayda paydalanıwdı bilesiz be?



Plastilinnen asxana buyımların islep kóriń. Olardı islew ushın, eń dáslep, olardıń dúzilisine itibar beriń. Islew texnologiyasın islep shıǵıń hám sol tiykarda jumıstı baslań. Plastilin menen islewde qanday qaǵıydalarǵa ámel etiw kerekligin umıtpań.



Plastilinnen úy-ruwzigershilik buyımı esaplanǵan tabaq islewdiń kórsetpegi kartası.

	<p>Tabaq islew ushın plastilinnen qalıńlıǵı 3 — 4 mm bolǵan lenta tárizli forma tayarlaymız.</p>
	<p>Olardı sheńber túrinde jaylastıramız. Soń qolımız benen sılap tegisleymız. Bul ıdısımızdıń túbin payda etedi.</p>
	<p>Tabaqtıń ústingi bólimin islew ushın birqansha juwan hám uzınıraq lenta tayarlań. Qolınız benen onı basıp jalpaytırń.</p>
	<p>Olardı tayarlanǵan forma túbine aylandırıp jabıstırıp shıǵamız hám qolımız benen tegisleymız.</p>

ÚY-RUWZÍGERSHILIK BUYÍMLARÍ MENEN TANÍSTÍRÍW HÁM ISLEW

Jasap atırǵan úyimiz qolaylı hám úy-ruwzi-gershilik jumısların orınlawda bizler hár túrli ásbap-úskenelerden paydalanamız. Aytırshı, bizler qanday mebellerden paydalanamız? Olar bir-birinen nesi menen parıqlanadı? Úy-ruwzigershilik buyımları qatarına neler kiredi? Ruwzigershilik júrgiziw ushın jáne qanday úskeneler kerek? Olardıń atların aytır.

Tapsırma. Kestede hár túrli úy ásbap-úskeneleri súwretlengen. Tapsırmanı orınlaw ushın qaǵaz hám qálem alır. Oǵan dáslep bólme úskeneleri, soń asxana úskeneleriniń atların jazır.



Adamzat ózi ushın qolaylıq jaratıw maqsetinde bárqulla izlenip, jańalıq ashıp kelgen. Sonıń ishinde, úy-ruwzigershiliginde paydalanılatuǵın buyımlar da bárqulla jetilip kelgen. Olar paydalanıw ushın qolay bolıp ǵana qalmaq, sulıw da bolıwı shárt. Bunıń ushın dizayner dep atalatuǵın kásip iyeleri xızmet kórsetedi.

Sizler de 4 jil dawamında texnologiya sabaqlıǵında hár qıylı materiallardan hár túrli shıraylı zatlardı islewdi úyrenip aldıńız. Qáne, dizaynerlik kásibi haqqında nelerdi bilesiz?

Dizayner — zatlar hám obyektlerdi bezew, olarǵa súwret salıw, súwret túsiriw menen shuǵıllanıwshı shaxs.



Ne ushın dizayner, eń dáslep, isleytuǵın zatınıń eskizin sızıp aladı?

Gúlalshılıq ustaxanasına sayaxat



Gúlalshılıq — ılaydan hár túrli úy-ruwzigershilik buyımları, ıdıs-tabaq islewshi usta.

Gúlalshılıq topıraq járdeminde gózzallıq jaratıwshi áyyemgi hám qaytalanbaytuǵın óner esaplanadı.

Gúlalshılıq áyyemnen rawajlanǵan xalıq ámeliy kórkem óneriniń bir túri. Ata-babalarımız ılaydan badiya tabaq, sháynek, kese, lawabı kese, oyınshıq, músin sıyaqlı hár túrli buyımlar islegen.

Gúlalshılıq ónimleriniń sapası, eń dáslep, buyım tayarlanatuǵın ılayǵa baylanıslı. Xalqımız «islew berseń ılayǵa kóp, onnan shıǵar naǵıs kóp» dep biykarǵa aytpaǵan. Gúlalshılar ılayı ápiwayı ılaydan pariq qılıp, ol gúlalshılıq óneriniń uzaq jıllıq tájiriybesiniń nátiyjesi bolıp tabıladı. Usı ılay mayısqaq hám jabısqaqlıq qásiyetine iye boladı. Áyyemde gúlalshılar ılay ushın topıraqtı jerdiń óz aldına qatlamlarınan jıllap izlegen. Búgingi kúnde hár qıylı temperaturada pisetuǵın ılay túrleri kóp, olar ulıwma atama da keramika yamasa gúlalshılıq ılayı delinedi. Burınları buyım islew ushın ayaq kúshi menen isleytuǵın shıǵırdan paydalanılǵan. Házirgi waqıtta shıǵırlar elektr toki járdeminde aylanadı. Islengen buyım shıǵırdan alınıp, sayada keptiriledi. Kepkennen keyin, ıǵal shúberek penen tegislenedi hám oǵan reń, naǵıs islenedi. Keyin jabıq kamera-da 500—600°C temperatura astında pisiriledi.

Ózińizdi gúlalshı dep esaplap, sińlińizdiń quwırshaǵı ushın úy-ruwzigershilik buyımlarınan tayarlap beriń. Bunıń ushın buyımlar tayarlawdı rejelestiriń.

Islemekshi bolǵan buyımıńız neshe basqishta orınlanıwı múmkinligin oylap kóriń.



Súwrette úy-ruwzigershilik buyımların islew jolları basqışpa-basqış kórsetilgen. Kórip shıǵıń hám islewge háreket etiń.

Krovat islewdiń kórsetpeli kartası

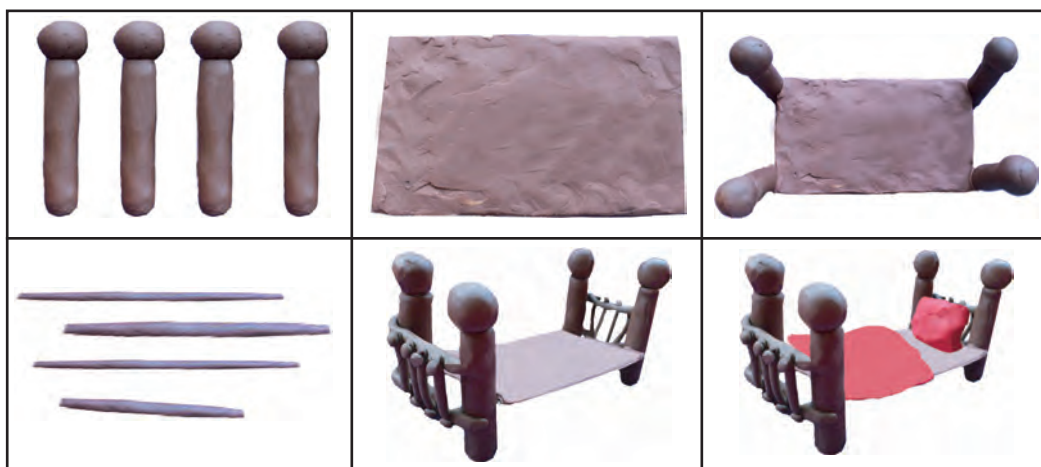

Saat sođıwdıń kórsetpeli kartası



Gúze sođıwdıń kórsetpeli kartası

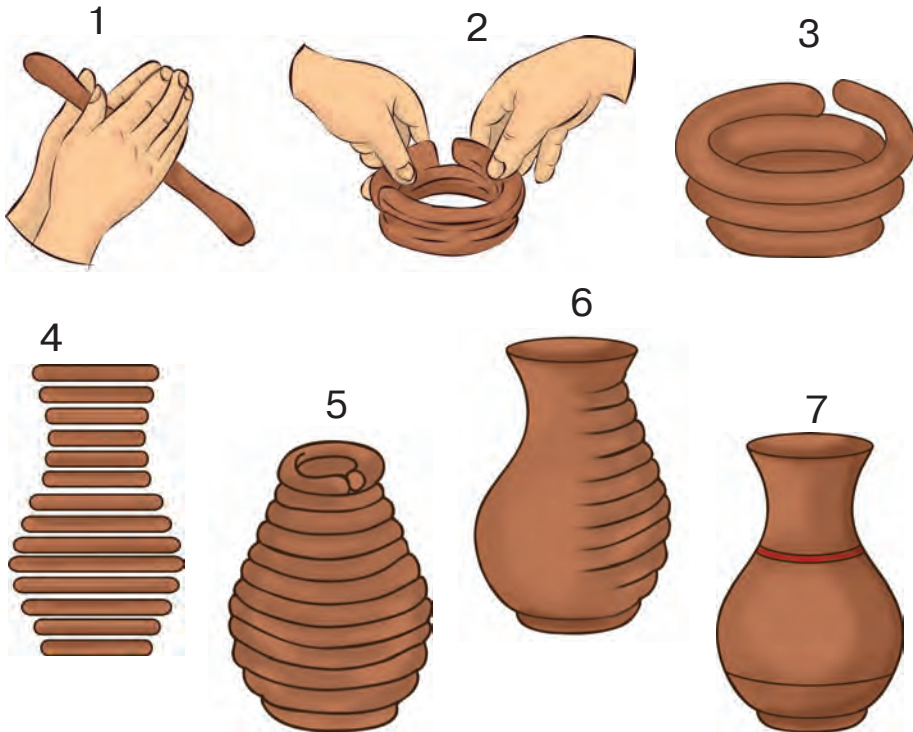



Súwretke dıqqat penen qarań?
Shay ishiw ushın kerekli ıdıslar
qoyılǵan ba? Qaysıları artıqsha?



Mine, úy-ruwzigershiliginde qollanılatuǵın úskene hám ásbaplar menen tanısıp aldırız. Bólmeler hám asxanani tártipli saqlawda analarıńızǵa járdem beresiz be? Járdemleskenińizde qanday jumislardı orınlaysız?



Anańızǵa járdemleser ekensiz, tómendegilerdi yadta tutırń!

Esikler hám tereze ramları sabın menen jilli suwda juwıladı. Aynalardı dáslep ızǵar, soń qurǵaq tawar menen taza bolǵanınsha sıpırırń. Ízǵar tawar menen laklenbegen hám tegislenbegen mebeller, qapılar, tereze aynaları, ısıtqısh ásbapları tazalanadı. Tegislengen hám laklengen mebeller bolsa túkli jumsaq tawar menen tazalanadı. Awqatlanıwǵa otırıwdan aldın álbette qoldı juwıw kerek. Stol átirapında durıs, stulǵa súyenbey hám stolǵa janbaslamay otırıladı. Awqatlanıp bolǵannan soń ıdıslardı juwıp qoyıw kerek.

ASPAZLIQTA TAYARLANATUĞIN QAMIR TÚRLERI

Aspazlıqta qamırdan hár túrli awqatlar tayarlanadı. Sebebi qamırdıń tiykarı bolǵan biyday, arpa, mákke, júweri dáni belok elementine bay. Sonday-aq, biyday unında 11 — 16% ke shekem azotlı elementler,



1 — 1,5% ke shekem may, 70 — 74% ke shekem kraxmal, 0,5% ten kóbirek minerallar bar. Sonlıqtan, qamırdan islengen ónimler toyımlı, mazalı hám kaloriyaǵa bay boladı. Házirde xalqımız drojsız qamır, ápiwayı drojlı qamır, drojsız hám sút, may, máyek salınǵan qamır hám de drojlı hám sút, may, máyek salınǵan qamırlardan paydalanadı.



Ápiwayı drojsız qamır.

Onı tayarlaw ushın dáslep tabaqqa duz salıp, biraz suw menen eritesiz. Keyin duzlı suwǵa elengen undı iyleysiz. Kerekli qattılıqqa kelgen qamırdı jaqsılap mushlaysız. Iylengen qamırınızdıń túyirsiz, yaǵnıy suw hám unnıń birdey aralasqanına itibarlı bolıń. Tayar qamırdı zuwala etip, boyın alıw ushın 10 — 15 minut orap qoyıń. Bul túrdegi qamır manti, pelmen hám laǵman tayarlaw ushın paydalanıladı.

Ápiwayı drojlı qamır. Jumıs drojdı tabaqta (mıs, sırlanğan, gúlal yamasa emallı) elewden baslanadı. Duz qosıp eritkenińizden keyin az-azdan un hám suw quyıp qamır iyleysiz. Tayar qamırdı zuwala etip, tabaqta qaldırasız. Ústın qalıńıraq súlgi menen orap, 1 saat ıssıraq jerge qoyasız. Qamırdıń kóteriliw waqtı oğan salınğan drojdıń muǵdarına baylanıslı boladı. Qamırdıń uzaq waqıt turıp qalmawına itibar beriń, bolmasa onnan tayarlanatuǵın ónimlerdiń dámi hám sıpatı buzıladı.

Drojlı qamırdan shórek, sheti qalıń nan, hár qıylı somsalar tayarlaw ushın paydalanıladı.

Joqarıda tayarlanıwı túsindiriliw ótilgen drojsız hám drojlı qamırǵa ózgeshe dám beriw ushın sút, may hám máyek ónimlerin de qosıwǵa boladı.

Bul ónimler tómenдеги izbe-izlikte qosıladı: suwdıń ornına sút quyıladı, izinen duz, may, droj hám máyek salıp jaqsılap aralastırıladı. Keyin aralaspaǵa un salınıp iylenedi, tayar qamır jaqsılap mushlanadı hám ashıw ushın alıp qoyıladı.

Pelmen



Qamırdı qattıraq etip iylep, zuwala islep, 10 minutqa shekem dem beremiz. Keyin oqlawda bir tegisetip jayamız. Jayılğan qamırdı kvadrat formasında kesip, oğan kesilgen gósh salıp búgemiz.

QAĞAZDAN PELMEN ISLEW

Sizge kerek boladı: salfetka, qağaz hám kley. Salfetkadan kerekli ólshemdegi 5x5, 6x6 sm li tuwrı tórtmúyeshlik formasın kesip alıń. Ortasına domalaqlanǵan (maydalanǵan gósh) qağazdı qoyıń hám búkleń. Barmaqlarınızdıń járdeminde aylandırıp, ushlarnı birlestiriń.

Birlesken jerin kley menen jabıstırıń. Mine, qağazdan islengen «pelmén»imiz tayar!



QAĞAZDAN PAPE-MASHE USÍLÍNDÁ BUYÍMLAR ISLEW

«Pape-mashe» sózi francuz tilinde «jıyırılğan qağaz» degen mánisti bildiredi. Pape-mashe — qağazdı maydalap, olardı jelim menen ústi-ústine jabıstırw jolı arqalı oyınshıq islew usılı. Bunıń ushın gazeta qağazı kerek boladı.

Maydalanğan qağaz qıyındıları PVA jelimi menen jabıstırıladı. Sonday-aq, un yamasa kraxmaldan tayarlanğan jelimmen de paydalanıwğa boladı. Pape-mashe usılında qanday da bir buyım islew ushın stol ústine eski klyonka salıń. Jumıs waqtında qolıńızdı súrtiw ushın súlgi de tayarlap qoyıń.

Pape-mashe usılında tarelka islew

Tarelkanı islew ushın sizge kerek boladı: tarelka, gazeta, jelim, qılqálem, lawabı kese, may yamasa vazelin. Dáslep gazetanı eni 2,5 sm, uzunlıǵı 10 sm bolğan bóleklerge bólip shıǵıń.





Tarelkaniń ústingi tárepine qılıqalem menen may (vazelin) jaǵıp shıǵırń hám onıń ústine birneshe qabat gazeta bóleklerin jabıstırırń.

Keyin jelim jaǵıp, ústinen gazeta bóleklerin izbeizlik penen bir tegis jastıstırıp shıǵırń. Jelim kepkenen keyin, onı tarelka-qalıbinen ajratıp alırń. Bunıń ushın tarelkaniń shetinen uslap, áste tartasız. Payda bolǵan tarelka formasınıń ústingi bólimine jáne bir qabat aq qaǵaz jabıstırırń. Tegis emes jerlerin qayshı menen tegisleń hám jelim qaldıqlarınan tazalań. «Tarelka» kepkenen keyin onı bezeń.





Óziñiz islep kórin



SABANNAN KÓLEMLI OYÍNSHÍQLAR ISLEW

Tómende berilgen súwretlerdi baqlań. Onda kór-kem óner ustaları tárepinen sabannan islengen sulıw jumıs úlgileri berilgen.



Saban hám jipten islengen oynshıqlar bir-birinen nesi menen ajraladı?

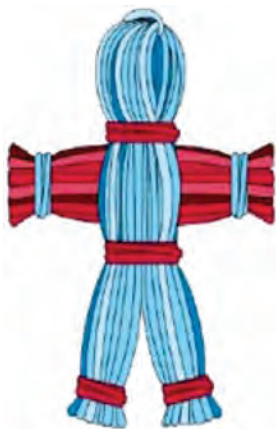

Islew ushın biyday, arpa, súli ósimlikleriniń sa-
banınan paydalanamız.



Saban menen islewde jası úlkenler (muǵal-
lim, ata-ana) járdeminen paydalanıń.

Ósimlik sabanın tayarlaw

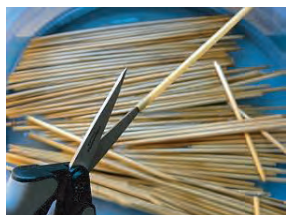

Sabandı islewge tayarlaw ush-
ın ol qırqıladı hám tazalanadı. Jumıs
procesinde saban sınıp qalmawı
ushın onı qaynaǵan suwda jibitip
alıw kerek. Bunıń ushın bir te-
gis saban paqalları tańlap alınadı.
Olar búgilmey, sındırılmay, úlkeni-
rek ıdısqa jaylastırıladı hám ústine
qaynaǵan suw quyıladı. Soń ıdıstıń
ústi qaqqaq benen jabılıp, birneshe
saat jibitiwge qoyıladı. Bunday islew
berilgennen soń saban iyilgish hám
bekkem boladı. Olardı ańsat iyiw
múmkin. Islew berilgen saban bólek
ıdısta saqlanadı.

Tegis aplikaciyalı jumıslardı orın-
law ushın saban paqalınan tegis
lentalar tayarlanadı. Bunıń ushın sa-
ban paqalı qayshı yaki ótkir pıshaq
járdeminde uzınına qırqıp alınadı.

Hárbir saban bólegi ıssı temperaturada utyug-
lenedi. Tayar sabanlar qutıǵa salınadı.

Utyuglengen sabanlar PVA jelimi menen qaǵaz betine bir-birine taqap, reńleri say islengen jaǵdayda jabıstırıladı.

Qaǵazǵa jabıstırılǵan sabanlarǵa tez ıssı temperaturalı utyug basıladı. Soń kitap arasına basıp qoyıladı. Tegislengen zattıń arqa tárepine kerekli súwret túsirilip qıyladı hám súwretin kórsetetuǵın tiykarǵı qaǵazǵa basqıshpa-basqısh jabıstırıladı.



1



2



3



4



Sabannan oyınshıq at islew

Súwretke diqqat penen qarań. Oyınshıq at qanday bóleklerden quralǵan? Onı qanday tártipte hám neshe basqısha islew múmkin?

Sabandı tayarlawda ol ne ushın ıssı suwda jibitiledi? Jibitilgen saban qanday qásiyetlerge iye?

At islew ushın sabannan úsh baylam tayarlap alıń. Birinshi baylamdı alıp, onnan attıń bası menen moyın bólimin isleń. Qulaqların islewdi de umıtpań.

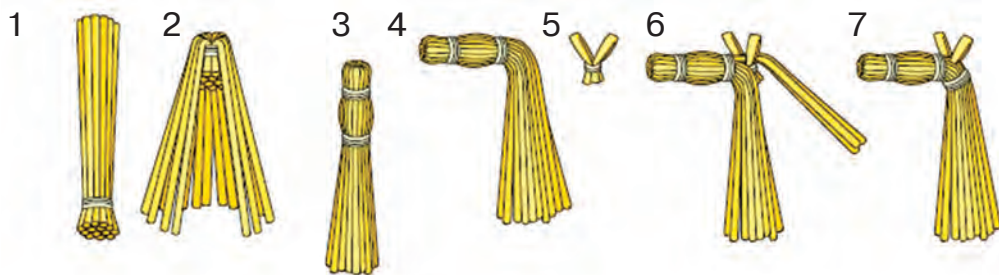

Moynına saban baylaw arqalı attı bezeń. Buniń ushın birneshe saban baylamlarınan paydalanıń.

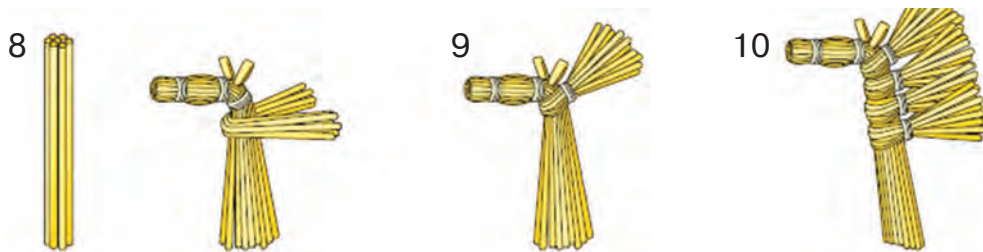

Denesi ushın ekinshi baylam sabandı alıń hám onı bas bólimi menen birlestiriń. Ayaqları ushın

úshinshi saban baylamın alıp, denesi menen birlestiriń hám ayaǵın jip penen baylań.

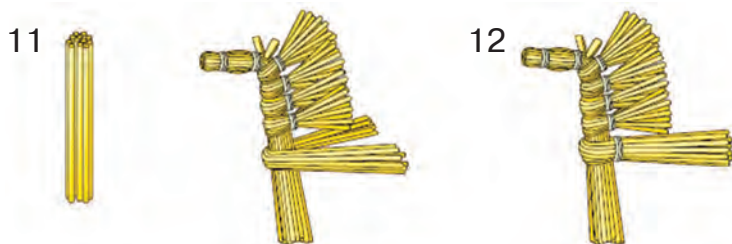

Moyın bóliminen qalǵan sabandı 2 bólekke bólip, aldınǵı ayaqların payda etiń. Attıń jalı hám ayaqların sabanǵa reńli jiplerdi baylap payda etiń.

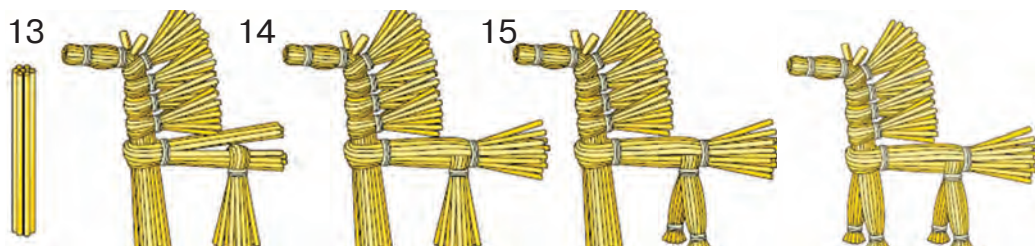

Sabannan tayarlaǵan súwret yamasa oyınshıǵıńızdan qayerde paydalanıw múmkin? Solay etip, sabannan zat islewdi de úyrenip aldırız. Jáne qanday súwretler islew múmkin?

Islegen zatırızǵa baha beriń:

- 1) ata-anańız bahası;
- 2) doslarıńızdıń bahası;
- 3) ózińiz bergen baha;
- 4) muǵallımıńızdıń bahası.



SABANNAN APPLIKACIYA USÍLÍNDÁ PEYZAJ TAYARLAW

Peyzaj islewde klaslalarıńız benen birgelikte jumıstı bólisip alıń. Soń saban menen islew tártibine ámel etken jaǵdayda jumıstı baslań hám islep bolǵan soń súwretti ulıwma karton qaǵazǵa jaylastırıń.

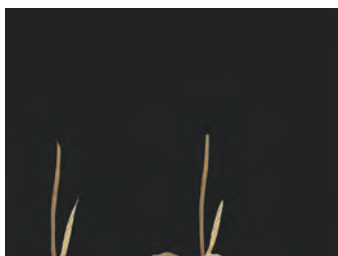

1



2



3

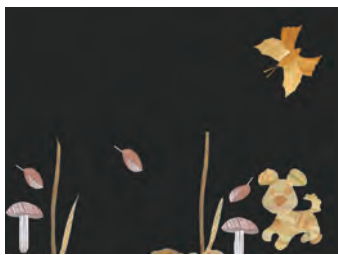

4

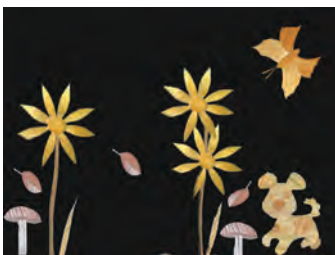

5



6



Ózińiz óz betińizshe isleń.



SUWDA JÚZETUĞÍN TRANSPORT ISLEW (KATAMARAN)



Katamaran — paluba menen birlestirilgen eki korpuslı kema.

Súwretke qarań. Katamaran islew ushın qanday zatlar kerek ekenligin eslep qalıń.

Sizge kerek boladı: muzqaymaq shóbi, qısqısh, domalaq tayaqsha.

Este saqlań! Muzqaymaq shóbinen paydalanǵanıńızda onı jaqsılap juwıwdı umıtprań.

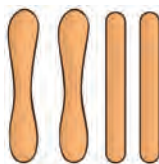
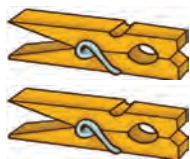

Qısqısh hám muzqaymaq shóbinen keme korpusın payda etiń. Bóleklerin PVA jelimi menen jabıstırıń. Jelimniń ornına skotchtan paydalanısańız da boladı. Katamaran ushın eki korpus isleymiz.

Keme korpusların muzqaymaq shóbi menen skotch yamasa jelim járdemi menen birlestiriń.

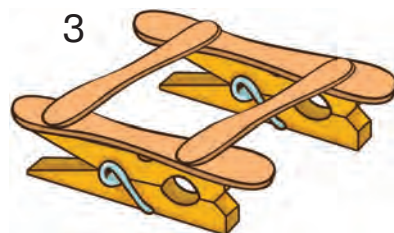
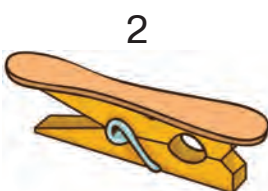
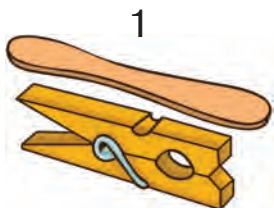

Jelqom isleń. Eni 8 sm, uzınlıǵı 13 sm li tuwrı tórtmúyeshli qaǵaz tayarlań. Applikaciya usılı menen bezetiń.

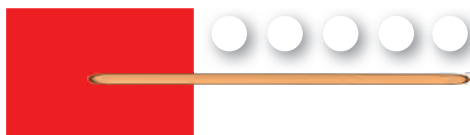

Jelqomdı machtaǵa* biriktiriń. Buniń ushin qaǵazdı puqtalıq penen tesip, domalaq tayaqshaǵa kiygiziń.

Machtanı ornatiń. Domalaq aǵashtı qısqa shqa bekkemleń.

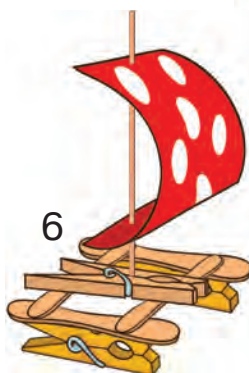
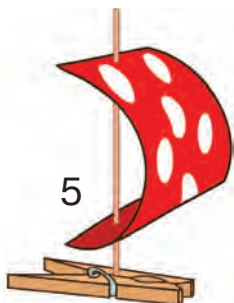
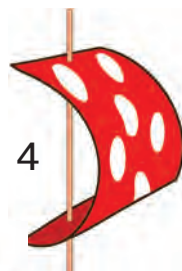

Islegen katamaranıńızdı suwǵa jiberiń. Ol suwda shókpey hám jıǵılmay turıwı ushin nelerge itibar beriwińiz kerek? Ne ushin ol suwda shókpeydi. Adamlar birinshi júzip júriwshi zatları qalay oylap tapqan? Katamarannıń wazıypası nelerden ibarat hám ol qanday materiallardan tayarlanadı?

***Machta** — katamaran jelqomları tartıw ushin qollanılauǵın biyik baǵana.

QIZIL JELQOMLI KEME ISLEW

Sizge kerek boladi: penoplast, qizil qaǵaz, machta ushin domalaq uzinsha shóp, tis shuqlaǵısh shóbi.

1. Úsh túrli ólshemdegi tuwrı tórtmúyesh forma qıyıp alıń.

2. Hárbir tuwrı tórtmúyesh-te tis shuqlaǵısh shóbi menen eki tesik payda etıń hám olardı machta ushin alınǵan domalaq shópke ornatıń.

3. Úlken-kishiligi boyınsha jaylastırın.

4. Kvadrat formasındaǵı penoplasttı alıń. Bir tárepin súwrette kórsetilgen sıyaqlı úshmúyeshlik formasında etip qıyıp alıń (kemeniń tumsıq bólimin soǵıw ushin).

5. Qaǵazdan úlken hám kishi eki bayraqsha qıyırın. Kishi bayraqshanı tis shuqlaǵısh shóbine jabıstırın. Úlken bayraqtı machta tóbesine jelimleń.

6. Machtanı penoplast ortasına jaylastırın. Kishi bayraqshanı tumsıq bólimine ornatırın.

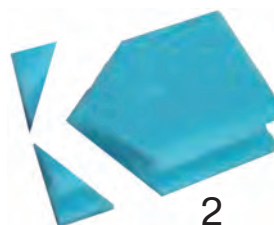
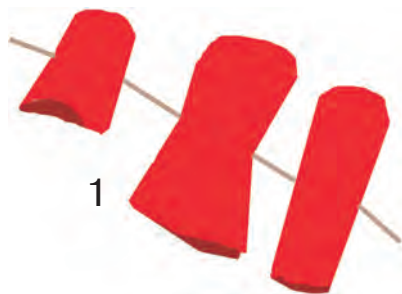

USHÍWSHÍ MODELIN ISLEW

Samolyot insańǵa qanday xızmet kórsetedi? Samolyotlardıń qanday túrlerin bilesiz? Samolyot qanday bólimlerden ibarat? Samolyottı kim basqaradı? Súwretke dıqqat penen qarań. Hawada ushıwshı modeller qanday materiallardan hám qalay tayarlanıwı, olardıń ólshemleri haqqında doslarıńız benen pikirlesıń. Ne ushın ólshemlerge ayırıqsha itibar beriw kerek?

Samolyot islew ushın eki aǵash tayaqsha alıń. Eki úlken tayaqshanı aspan kók reńge, kishi tayaqshanı bolsa, qızıl reńge boyañ. Boyaw kepkennen keyin tayaqshanı qısqıstırń tómenge hám ústingi tárepine qanat etip jabıstırń. Kishi tayaqshanı samolyottıń quyırq bólimine jabıstırń. Joqarǵı tárepine aǵashtan úshmúyeshlik islep jelimleń. Jelim kepkennen keyin qısqıstırń astına magnit jabıstırń.



1



3



2





O‘ZIÑIZ ISLEP KÓRIÑ

Mına samolyottı islew ushın ápiwayı nay tári-zli karton alıń. Súwrettegi sıyaqlı búgilgen forma qıyıń. Bunda ushıwshınıń bólmesi payda boladı. Kartondı tegisleń, samolyot qanatı hám quyırığın ornatiw ushın kesik tayarlań. Qanat, dóńgelek, quyırığın bolsa basqa kartonnan isleń. Reń me-nen boyañ. Boyaw kepkennen soń qanatların hám quyırqların kesik orıńǵa jaylastırıń. Dóńgeleklerin sım menen bekkemleń.



Ushıwshı kásibi haqqında maǵlıwmat toplań.

POLIMER MATERIALLARDAN OYINSHIQ ISLEW



1



2



3



4



5



6



7

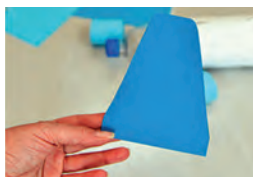

8



9



10



11



12



13



14



15



16



AYAZBABA USTAXANASINDA YOLKA BEZEGIN ISLEW

Jańa jil bayramı ushın úyińizde hám klasıńızda yolka bezeledi. Yolkanı bezewde bolsa eń jaqsı bezek bolıp ózińiz islegen oyınshıq bolıp esaplanadı.

Oyınshıqlardı qanday materiallardan islew múmkin? Olar neshe bólimnen ibarat boladı?

Oyınshıq tayarlaw ushın:

- 1) reńli qağazdan uzınsha lentalar qıyıp alıń;
- 2) olardı birge toplań, ekige búkleń. Bunda kitapsha forması payda boladı;
- 3) onıń ortasın stepler járdeminde birlestiriń;
- 4) endi kitapshanıń birinshi betin ekige búklep jelimleń;
- 5) qalğan betlerdi de usı tárizde jelimlep shıǵıń.

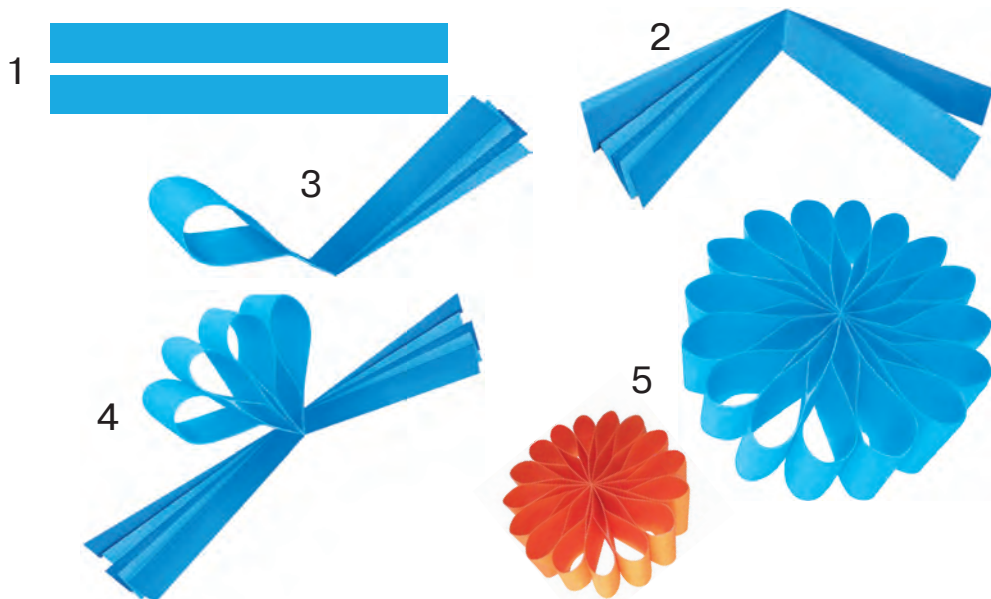

YOLKANÍ BEZEW USHÍN MARJAN ISLEW

Jańa jil yolkası marjanın islew ushın sizge kerek boladı: reńli qaǵaz, karton, jelim, qılqálem, qayshı.

Marjan islew ushın kartonnan cilindr payda etiw hám onı reńli qaǵaz benen orap jabıstırıń.

Uzunlıǵı 170 mm bolǵan reńli qaǵazdıń aralıǵı 5 mm den etip lenta tárizli formada qıyıp shıǵıń.

Tayarlanǵan lenta tárizli formanıń joqarǵı bólimine jelim jaǵıp, cilindrge tegis etip jabıstırıń.

Hár qıylı reńdegi lenta tárizli formalardı jabıstırıp bolǵannan keyin yolkaǵa ildiriw ushın lentanı da jelimleń.

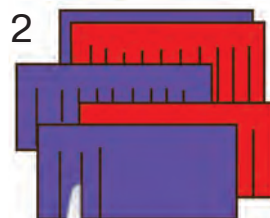
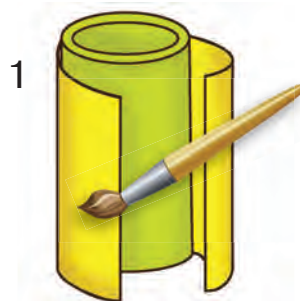



SHAR FORMASINDA YOLKA OYINSHIGIN ISLEW

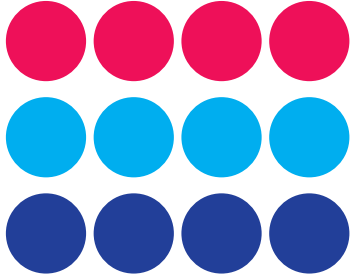

Bunday yolka oyınshıgın islew ushın reńli qaǵaz, sım, stepler hám jelim kerek boladı.

Dóńgelek úlgisin alıp, úsh qıylı reńli qaǵazdan 12 birdey dóńgelek qıyrń. Hár bir dóńgelekti ekige búkleń. Búklegende bir ashıq kók, eki toyǵın kók, eki qızıl eki ashıq kók, eki toyǵın kók, eki qızıl hám bir ashıq kók dóńgelekshe qoyırń.

Dóńgeleklerdi stepler járdeminde bir-biri menen biriktiriń.

Tegisleń hám hár bir dóńgelektiń yarımın ekinshi dóńgelektiń yarımı menen jelimlep jabıstırırń. Bunda hár bir dóńgelektiń yarımın aldınǵı dóńgelek penen joqarǵı tárepinen, keyingisi menen bolsa, tómenge tárepinen jabıstırırń.



QAĞAZDAN YOLKA ISLEW

Qağazdan yolka islew ushın reñli qağaz, qayshı, sim, jelim, qılqálem kerek boladı.

Reñli qağazdan hár qıylı ólshemde dóńgelekler tayarlañ hám olardı sektorlarǵa bóliñ. Sektorlardı belgilengen sızıqlar boyınsha súwrettegidey etip jabıstırıñ. Tayar bolǵannan keyin simǵa jaylastırıñ. Yolkanıñ ushındaǵı figuranı yarım dóńgelekten payda etiñ.

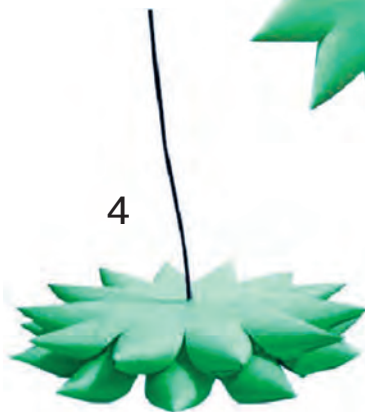
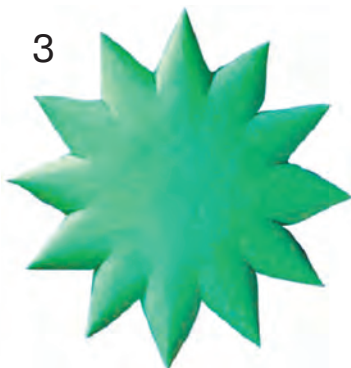
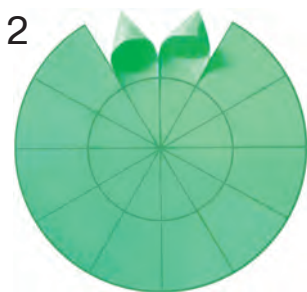
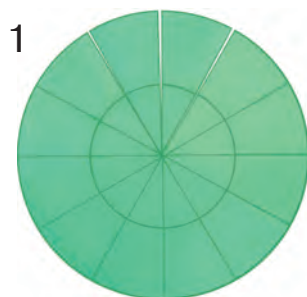

QUTLIQLAW SAWĠASÍN ISLEW

Siz buyımlardıń basqıshpa-basqısh isleniwin jaqsı bilip aldırız. Súwrette jańa jil qutlıqlaw sawġasın tayarlaw basqıshları kórsetilgen. Dıqqat penen qarasańız, izbe-izlik almasıp, qalğanın bayqaysız. Islewden aldın bolsa izbe-izlikti belgilep alıń.

Este saqlañ! Qaġazdı ısırap etpew hám de qayshı hám jelim menen islew qaġıydalarına ámel etiń.

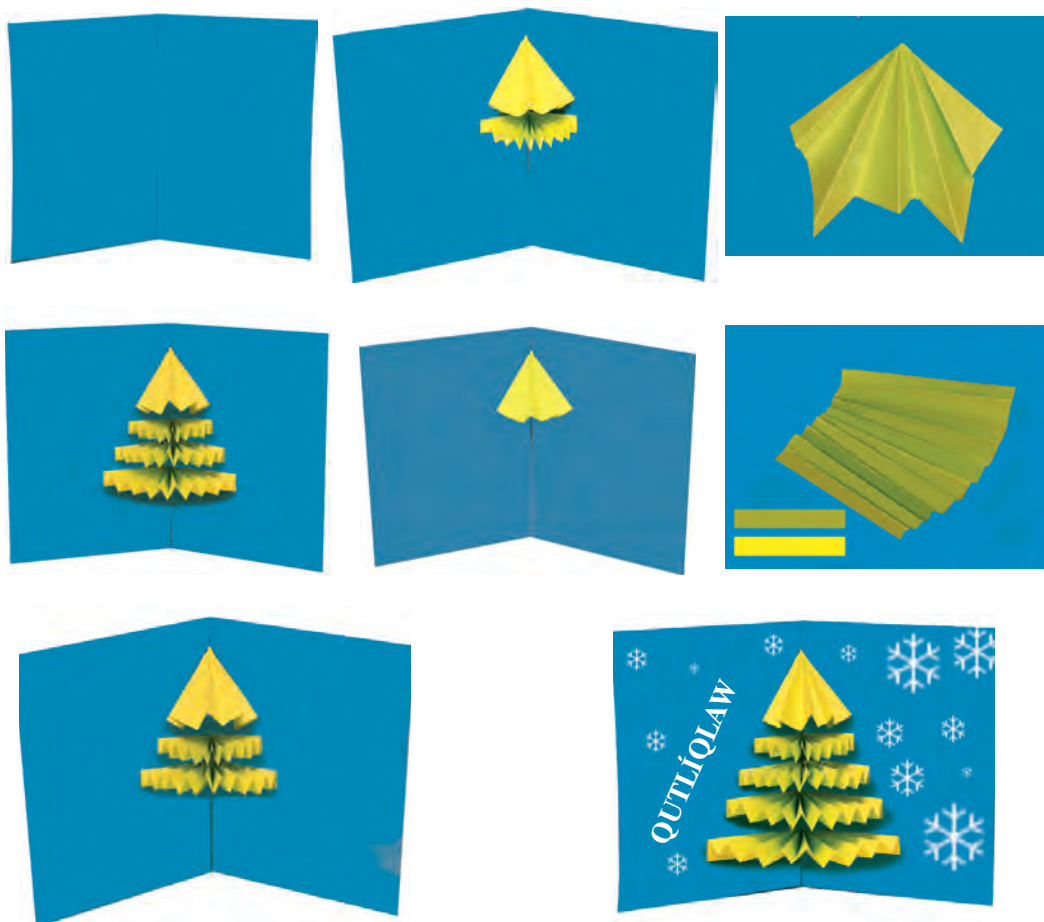

ERTEK QAARMANLARÍN ISLEW

Súwrette súwretlengen ertek qalay ataladı? Bul ertekte kimler qatnasadı?



Ertek tekstin oqıǵansız ba? Ertek qaharmanların esley alasız ba?



Plastilin menen islew texnologıyası

Zat islewden aldın plastilindi qolırız penen jum-sartır.

Haywan hám oynshıqlar formasın islew ushın olardıń úlken bólimin islewden baslań. Haywanatlar formasın islew ushın dáslep onıń denesi hám bas

bólimin islep, olardıń qatnasların salıstırın hám soń birlestirin. Mayda bólimlerin jabıstırıwda músinshilik qálemi (stek) nen paydalanın. Ol formanıń dene hám bas bóliminde oyınshıqlar payda etiwde qollanıladı. Bul oyınshıqlarǵa bolsa kóz, murın, quyırq hám qulaq jabıstırıladı. Sonday-aq, stek artıqsha plastilindi alıwda da járdem beredi. Bólimler bir-birine bekkem jabıstırılǵannan keyin, jabısqa jerlerin stek penen tegislep qoyın.

Eslep kórin, qaysı ertekte túlki hiylekerlik etedi? Ertek avtorı kim? Ertek qaharmanların islep kórin. Bunın ushın jumıstı neden baslaw kerek? Dáslep dene dúzilisine qarap—máyek tárizli, basına qaray—domalaq formalardı islep alın. Soń qol hám ayaqların uzınsha formada islep, dene bólimine, kóz, murın, qulaq hám quyırqın islep, bas bólimine jabıstırın.



Jumıstı islew tártibi.

1. Topardaǵı doslarıńız penen jumıstı bólisiw alın.
2. Kompoziciyanı dodalań.
3. Toparda pikirlesiw qaǵıydasın esten shıǵarmań.
4. Plastilin menen islewde qáwipsizlik texnikası qaǵıydalarına ámel etiń.

Ertek qaharmanların islewdiń kórsetpe kartası





PLASTILINNEN SEBET KÓTERGEN TÚLKINI ISLEW

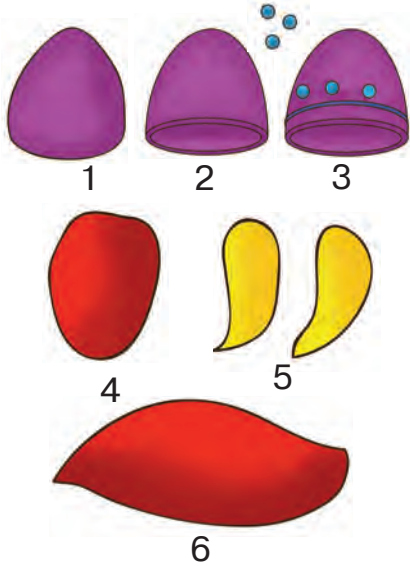

Eslep kóriń, qaysı erekte túlki sebet kóterip júredi? Sol qaharmandı islew ushın qanday tayarlıq kóriw kerek? Bunıń ushın jumıstı neden baslaw kerek?

Eń dáslep, plastilinnen túlkiniń konus formasındaǵı kof-tasın isleń hám onı sádepler menen bezetiń.

Keyin qol hám ayaqların, sońında bolsa, quyırǵın soǵamız.

Túlkiniń bas bólegi geshir sıyaqlı kóriniske iye boladı. Oǵan qulaq, murın hám kózler ornatıladı. Jumıs sońında bas bólimin denege jalǵap, yubka, qol, ayaqların hám de quyırǵın óz ornına birlesti-rip shıǵıń.

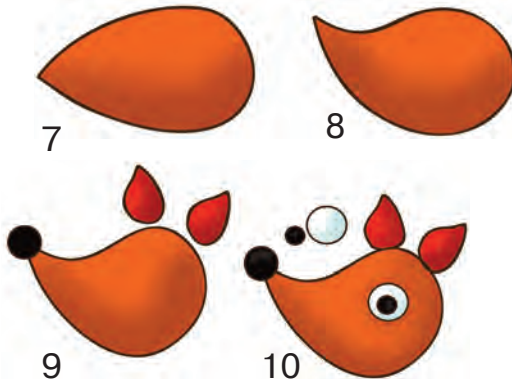

JIPTEN OYINSHÍQ ISLEW

Jipten nelerdi islew múmkinligin bilesiz be?

Máselen, onnan jumsaq shar islew múmkin. Bunday sharǵa pópekli telpek dep te ayıladı.

Onı islew ushin eki kartonnan úlgi tayarlap alıń.

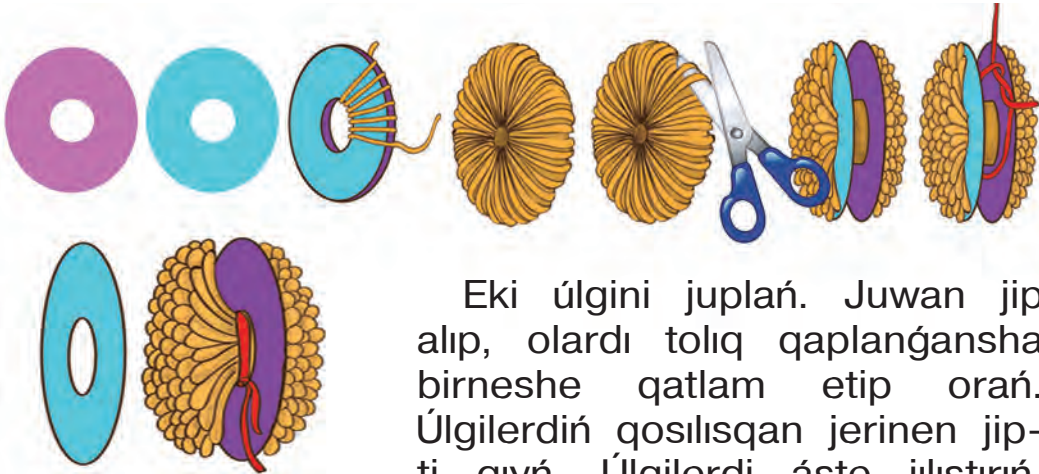

Eki úlgini juplań. Juwan jip alıp, olardı tolıq qaplanǵansha birneshe qatlam etip orań. Úlgilerdiń qosılısqan jerinen jipti qıyń. Úlgilerdi áste jilistirıń, biraq alıp taslamań. Olardıń arasındaǵı jiplerdi baylaǵannan keyin ǵana alıwıńız múmkin. Jipti pópekli telpek payda bolǵanǵa shekem durıslań. Payda bolǵan formadan hár qıylı zatlar islewińiz múmkin. Eki pópekli telpek tayarlań. Oǵan qaǵazdan kóz, qulaq, murın islep jabıstırıń.

JIPTEN SEGIZZAYAQ ISLEW

Segizzayaq islew ushın sizge kerek boladı: reñli jip, qayshı hám reñli qaǵaz.

Qáne, segizzayaqtı jipten qalay islew múmkin?

Reñli jip alıp, onı ortasınan baylañ. Bas bólegi bolatuǵın tárepin belgilep alıñ hám basqa reñdegi jipti barlıq jipler astınan ótkerip baylañ.

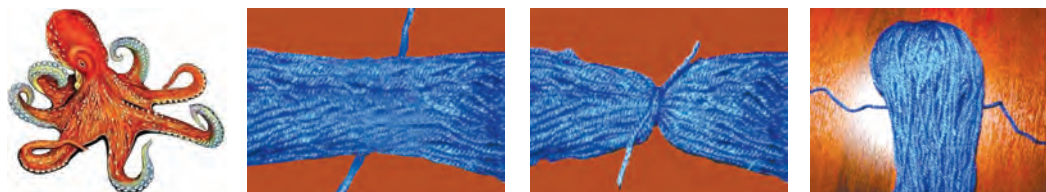

Ayaqlar ushın jipti teñ bóleklerge ajratıñ. Keyin olardı mayda etip orap shıǵıñ. Ushların jip penen baylañ. Mine, segizzayaq tayar boldı! Endi reñli qaǵazdan gúller islep, oyınshıǵıńızdıñ ayaqların bezeñ.

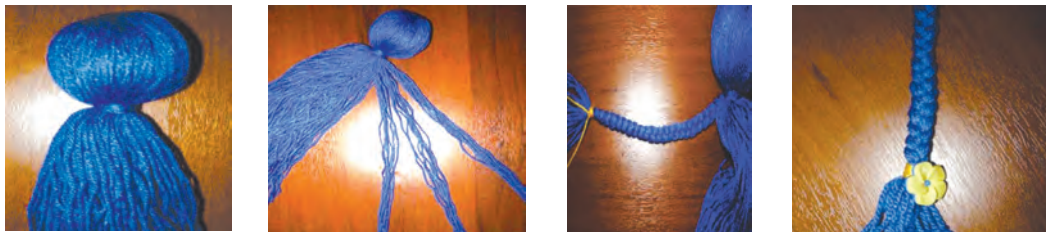



Ata-anańız penen birgelikte islep kóriń

Bunıń ushın sizge kerek boladı: silikatlı kancelyariya jelimli hám plastmassalı ıdı; aq oramlı jip (№40—60); jip ushın shiyshe ıdı; qayshı; juwan hám uzın iyne; oyınshıq shar; reńli qaǵaz.

Balalar oyınshıq sharın alıń. Onı úplep isiriń. Domalaq jipti shiyshe ıdısqqa salıń. Iynegge jip ótkeriń hám silikat jelim ıdısqqa iyneni shanshıń. Keyin iyneni suwrıp, shúberek penen tazalap alıp qoyıń.



Shep qolıńızǵa shardı alıp, jelimli jipti asıqpastan sharǵa orap shıǵıń. Jipti sharǵa bekkemirek orawǵa háreket etiń. Jip qansha az oralsa, forma sonsha kórkem kóriniske iye boladı.

Sonnan keyin keptiriw ushın qoyıń. 4 saat ótkennen keyin, jip ortasındaǵı shardı iyne menen tesip alıwıńızǵa boladı. Bul formalardan hár qıylı oyınshıqlar, yolka bezeklerin islewge boladı.



GEZLEMEDEN JUMSAQ OYINSHÍQ TIGIW

Qálegen gezleme bólegin alıń hám utyugleń. Kartonnan tayarlanǵan sheńber úl-gisin gezlemeniń teris tárepine qoyıp, bir tegis sheti boylap qálem menen sızıp shıǵıń. Gezlemede sheńberdiń sızıl-ması payda boladı. Onı qıyıp alıń. Tuwrı dónes tigus penen dógerek shetlerin tigip shıǵıń.



Tigus baslanǵan jerge kelgennen keyin, sabaqtı tartıp, gezlemeni qatlam-qatlam etip jıynań. Pay-da bolǵan qaltashanıń ishın paxta menen toltırıń. Paxtanıń ornına cintepon, gezlemeniń mayda bó-lekleri, hár túrli toqıma jiplerinen paydalanıwǵa bo-ladı. Eger onıń ishine cellofan paketin salsańız, oynaǵan waqıtta shıtırlaǵan ses shıǵadı. Qaltashanı tıǵızlap yamasa bosıraq etip toltırıwrıńızǵa da boladı. Soǵan qarap islengen oyınshıq ózgeredi. Qaltasha toltırılǵannan keyin jipti aqırına shekem tartıń hám tigus sótilmewi ushın tigiw juwmaqlanǵan bólimge bekkemlep túyip qoyıń.

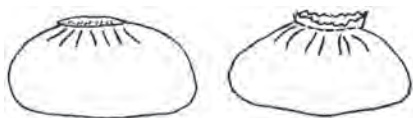

Toptırń tóbe bólimindegi búrmelerdi qıya tigis járdeminde qaltasha ishine búklep tigip qoyırń. Usı tártipte ekinshi toptı da tayarlap alırń. Bul oyınshıqtırń bas bólegi boladı. Úlgi járdeminde jáne eki kishkene top tigip alırń. Olar ayaqlar wazıypasın atqaradı. Toplardırń jibin tartıp bekkemlewden aldın olardıń hárbiriniń ishine baylağısh qoyırń. Usı tártipte kóz hám tumsıqlardı da islep alırń. Jumıs barlıq bóleklerdi óz ara birlestirip shıǵıw menen juwmaqlanadı. Bul dóretiwshilik úlgisi ushın qosımsha bezewlerdi ózińiz tańlawırńız, qálewińiz boyınsha alıwırńız hám oyınshıqqa qosımshalar kirgiziwińiz múmkin.





BEZELGEN OYINSHIQ KÓPSHIK TIGIW

Úlgini qaǵazǵa sızıp alıń. Tayarlanǵan gezlemeniń ońın ishki tárepke qaratıp eki búkleń. Búklengen gezlemege úlgini qoyıń hám qálem menen sızıp alıń. Sızıq boyınsha qayshı menen qıyıń. Mine, sizde qıyılǵan kópshiktiń eki tıs bólegi payda boldı. Olardıń birewine kóz hám murın ornın belgilep, tigip shıǵıń.

Eki kópshiktiń tıs bólegin awdarıp, olardıń shetlerin birlestirip tigip shıǵıń. Bunda belgili bir jerin tikpesten ashıq qaldırıwdı umıtpań.

Pútin kópshiktiń tıs bólegi tayar bolǵannan keyin ashıq qaldırılǵan jerden gezlemeni ońına awdarıń. Kópshik tısınıń ishine paxta salıp toltırıń. Ashıq jerin bolsa tigip qoyıń. Bul bezelgen kópshikti anańız benen birgelikte tayarlasańız jáne de jaqsı.





ОЙЫНШЫҚ ТИГІВ

(Úyde óz betinshe islew ushın)

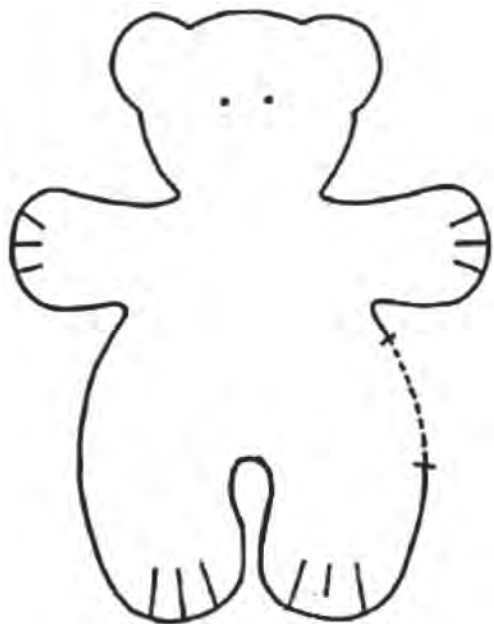

JÚK MASHINASI MODELIN ISLEW

Sabaqlıqtađı sızılmanı dıqqat penen úyreniń. Tayarlanđan úlgini qađazđa qoyıp sızıp alıń hám qıyıń. Atalıwına qarap bólimlerin ornalastırıń.

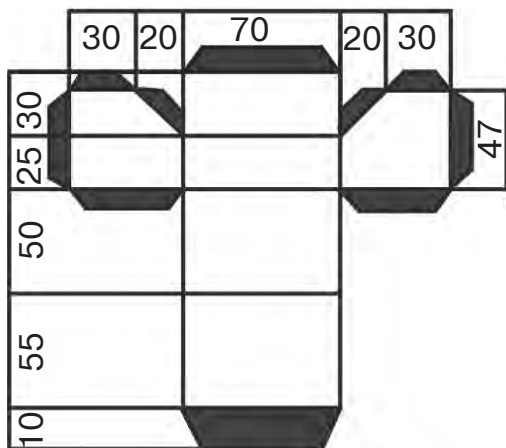

Kabina

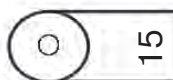
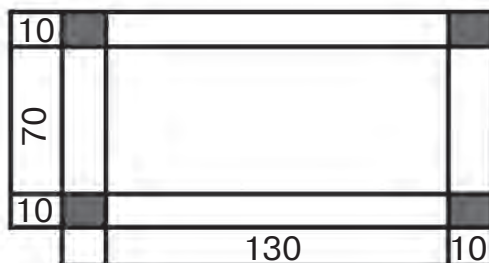

Kuzov astındađı tayanısh

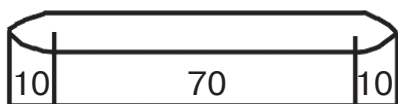
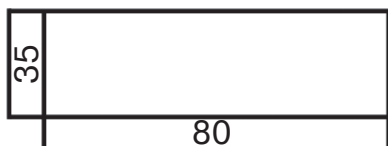

Kronshteyn

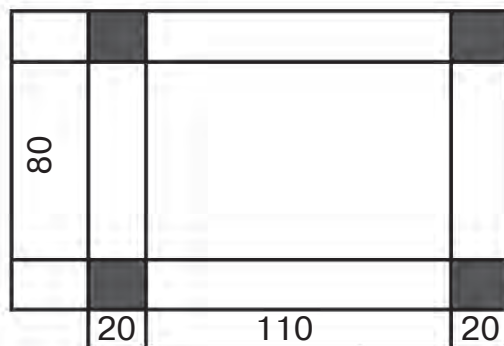

Kuzov



AVTOMOBIL MODELIN ISLEW

Shırpı qutısınan avtomobil modelin tayarlawda órt qáwıpsızlıgı qaǵıydasına ámel etiwdi umıtpań.



1



2



3



4



5



6



7



8



9



10



11



12



13



14



15



16

8-MART BAYRAMINA QUTLIQLAW SAWGASI

Kvilling — uzınsha hám ensiz qaǵazdı oraw (máselen, biz, tis shuqlaǵısh shóp átirapında) arqalı názik tárizde islengen forma. Bunda qaǵaz spiral tárizli bolıp qaladı hám onı ózgertiw arqalı basqa hár qıylı formalardı payda etiw múmkin. Qaǵazdıń eki tárepi de reńli bolıwı kerek. Kvilling payda etiw ushın qaǵazdıń eni 3—7 mm bolıwı talap etiledi.

Qaǵazdı eki barmaǵıńız benen uslań.

Sonday jaǵdayda onı ekinshi barmaǵıńız tırnaǵı menen tegislep, qaǵazdıń ushın qayırıń.

Ushı qayırılǵan qaǵaz aǵash-tan tayarlanǵan arnawlı tegis jińishke tayaqshaǵa tez oraladı. Qaǵazdı tıǵız etip orawdı umıtpań.

Eger qaǵazdıń diametri 3—4 mm bolsa, bizdi qoyıp, barmaqlarıńız benen de orasańız boladı.

Spiral tárizli formanı biraz ashıw ushın barmaqlarıńızdı bos qoyıń.



Spiral jayıp ketpewi ushın PVA jelimi menen áste jabıstırıp qoyıń.

Spiral tárizli formanı barmaqlarız benen ezıp, hár qıylı formalar payda etiwiriz múmkin.

Bul formalar járdeminde hár qıylı zat-buyımlar islep kóriń.



BAYRAM QUTLIQLAW SAWĠASÍN ISLEW

8-mart — Xalıq aralıq hayal-qızlar bayramı. Bul kúni hámmemiz mehriban analarımızǵa, gózzal apa-sińlilerimizge sawǵalar úlestiremiz. Perzenti óz qolları menen islegen bayram sawǵası bolsa áziz analarımızdı jáne de quwandıradı. Ózińiz islegen naǵıslı qutlıqlaw sawǵasına kewlińizdegi jaqsı tilek sózlerińizdi jazıp, anańızǵa sawǵa etseńiz, olardı jáne de kewillendirgen bolasız. Sizge birneshe kvilling texnikası menen tayarlanǵan qutlıqlaw sawǵasın beremiz. Olarǵa dóretiwshilik penen qatnas jasap, úyrengen kvilling texnikası tiykarında ózińizde islep kóriń.





ÓZIÑIZ ISLEP KÓRIÑ

Qutlıqlaw sawǵasın islew ushın sizge kerek boladı: reñli qaǵaz, qayshı, jelim hám salfetka.

Reñli qaǵazǵa úlgi boyınsha gúl hám japıraqtıń súwretin túsiriń. Payda bolǵan formalardı qayshı járdeminde qıyp alıń.

Gúldiń orta bólimine domalaq formanı jabıstırıń hám qutlıqlaw sózin jazıń. Tayarlanǵan gúl hám japıraǵıńızdı belgilengen orınǵa jabıstırıń.

1

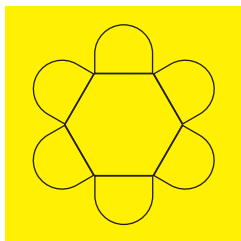

2

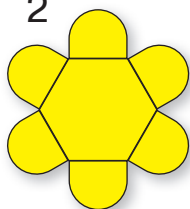

3

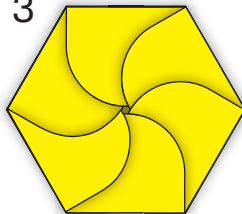

4

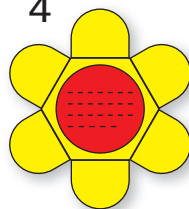

5

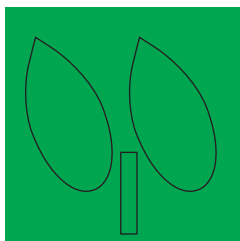

6

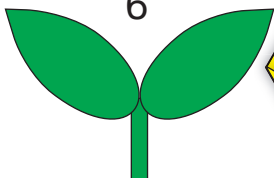

7

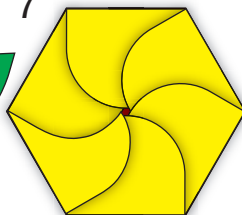

8

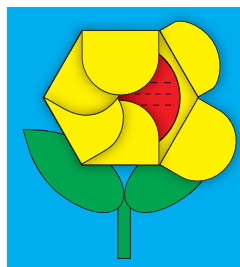

NAWRÍZ BAYRAMÍNA QUTLÍQLAW SAWĠASÍN ISLEW

Qalıń qaǵazǵa qálegen forma-
madaǵı gúldiń súwretin salıń.

Salıńǵan gúl formasınıń bir
bólegine kley jaǵıń.

Kvadrattı naysha etip, tis
shuqlaǵısh ushına orań.

Tis shuqlaǵıshtı shıǵarıp alıń
hám gúldi sızıq boylap jabıstırıń.

Keyingi nayshalar da solay
etip jabıstırıladı.

Nayshalardı bir-birine jaqın
jaylastırw kerek.

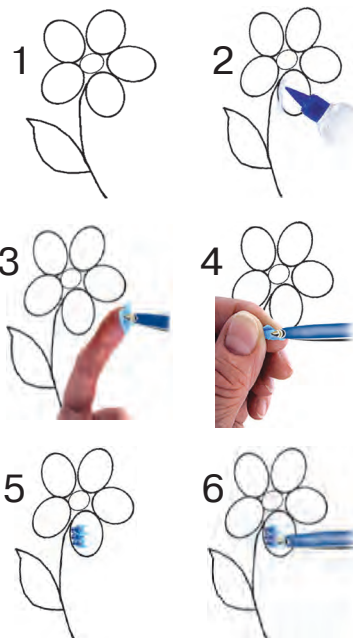



ÓZIŃIZ ISLEP KÓRIŃ

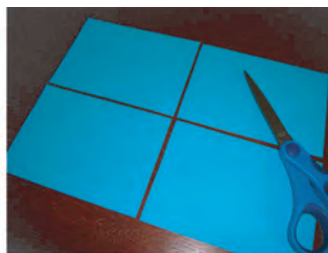



«GÚLZAR» KÓRINISIN KVILLING USÍLÍNDÁ ISLEW

Kvilling usílna gúlzar kórinisin klasaslaríniz be-
nen birgelikte isleń. Kvillingnıń hár túrli usılınan
paydalanıp, gúlzar isleń.



TIGIWSHILIK

Sizler kiyetuđın kiyimlerdi kim tikkenin, ol qanday gezlemelerden tayarlanǵanlıǵın bilesiz be? Kiyimdi taza tutıwdıń paydalı táreplerin sanap bere alasız ba? Qanday túrdegi gezlemelerdi bilesiz? Tómeńde ótkerilgen tájiriybeden neni bilip alıw múmkin? Ne ushın gezlemenıń qásiyetin biliwimiz kerek? Kiyim-kenshekler qanday gezlemelerden tayarlanadı? Ne ushın kiyim-kenshekler hár qıylı gezlemelerden tigiliwin oylap kóriń.

Tábiyiy



Ximiyalıq



Qaysı gezleme tez jibiydi





Qaysı gezleme kóp jıyırıq boladı

GEZLEMEDEN ZATLAR TIGIW

Ózińizdi sınań:

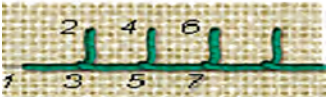
- 1) qaǵaz hám qálem tayarlap alıń;
- 2) hárbir qatarda berilgen tigis túrleri atına tuwrı keletuǵın sanlar ornın almastrıń.

A		1	Shıńjır tárizli tigis
B		2	Naǵıs tárizli tigis
D		3	Naǵıslı tigis
E		4	Bir túrdegi tigis

Sızılma durıs kórsetilgen súwretti tabıń hám cıfrın qaǵazǵa jazıń.

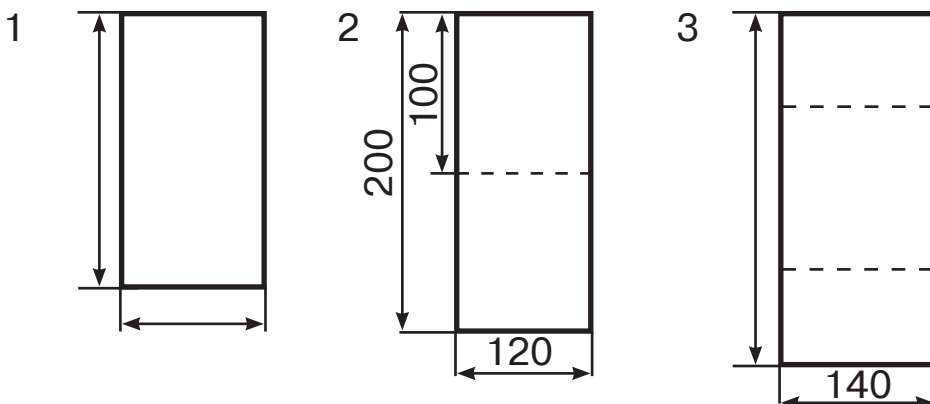

Gezemelerden buyımlar tómendegi tártipte tayarlanadı:

- 1) gezeleme tańlanadı;
- 2) úlgi tiykarında bólimler belgilep alınadı;
- 3) belgilengen bólimler qıyıladı;
- 4) islew beriledi hám tigiledi.

Qol oramal tigiw ushın gezeleme tańlap alıń. Ólshemin belgileń hám qıyırń.

Tigiw ushın sizge qanday material hám ásbaplar kerek boladı?



Qol oramal shetine islew beriw



Qol oramaldırń sheti tegis hám bekkem bolıwı kerek. Bunırń ushın onırń shetin 1 sm etip búkleń hám tuwrı tigiste tigiń. Tigip bolgannan soń anańız járdeminde utyugleń. Iyne hám qayshı menen islewde qáwipsizlik texnikası qağıydalarına ámel etiń.

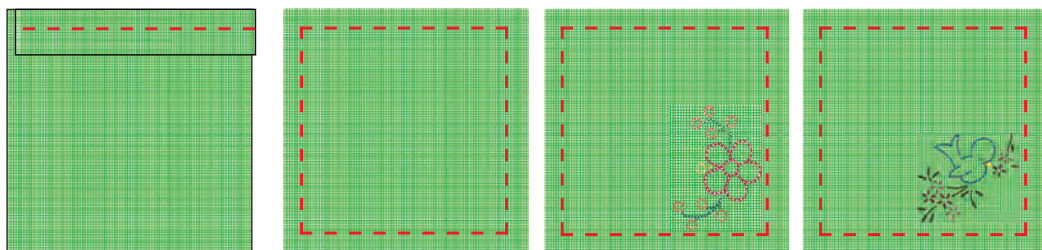

GEZLEMEDEN GÚLDÁSTE ISLEW

Gezleme gúllerinen gúldáste tayarlawda applikaciya usılnan paydalanıladı. Eń birinshi jumıs — gezlemedegi gúllerdi qıyıp alıw. Qıyıp tayarlanǵan gúllerdi jabıstırıw ushın olardıń reńine sáykes túrde reńli qaǵazdan túbin tayarlap alıń. Tayar túpke gúllerdi jaylastırıp shıǵırń hám jelimleń. Gúldásteniń japıraǵın da materialdan qıyıp alasız hám jabıstırasız. Gúl túbin bolsa, reńli qálem menen sızıp qoyıń.



Siz de gezleme gúllerinen paydalanıp, gúldáste isleń.



Gúldáste islew ushın tayar úlgini gezle-
mege qoyıp qıyıp tayarlap alıń. Tayarlap
alǵan formalardan kompoziciya isleń.



1



2



3

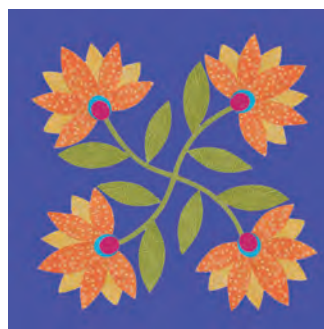

4



TOQIW HAQQINDA MAĞLÍWMAT



Toqiw dáslep adamlar turmısında zárúrlík sebepli payda bolǵan. Áyyemde olar turmısta ózlerine kerekli zatlardı ápiwayı materiallardan paydalanıp tayarlaǵan. Toqiw jıllar dawamında rawajlanıp, haqıyqıy kórkem óner dárejesine kóterildi. Toqılǵan zatlar ıssı, bekkem hám shıdamlı. Siz de shıdamlılıq penen jip hám ilmek járdeminde shıraylı zatlar toqıp, jaqın adamlarıńızdı quwandırıwıńız múmkin.

Buyımlardı qol menen toqiw ushın kegey (spica) yaki ilmek kerek. Kegey hám ilmek penen islegende qáwıpsızlık texnikası qaǵıydasın este tutıń hám jumıstı tamamlap, ásbaplardı arnawlı qapqa salıp qoyıwdı umıtpań. Buyımlardı jún jip, jún aralasqan jip, jipek jip, paxta jip, qoyan hám eshki túbitinen de, ızǵar jiplerden de toqıwǵa boladı. Kiyim-kenшекler bos iyirilgen jiplerden, dasturqan, salfetka, jaǵa, sumka, sıyaqlı buyımlar iyirilgen jipten toqıladı.

Kegey járdeminde toqiw



Buyım toqıǵanda hár eki tárepi ushlı tuwrı kegeyi hám saqıyna tárizli iyilgen diametri hár qıylı toqiw kegeyelerinen paydalanıladı. Kegey menen toqıǵanda jún jip qollanıladı.



Kegey — toqıw ushın isletiletuǵın ásbap (spica).

Kegey menen toqıwdı orınlaw tártibi:

Jipti súwrette kórsetilgenдей etip uslaw kerek. Saqıyna toqıw ushın birden eki kegey alınadı.

Olardı jup etip uslap, ushın jiptiń astına kirgizip kórsetkish barmaqtań ústinde turǵan jipti ilip alıw hám bas barmaqtaǵı saqıyna arqalı tartıp shıǵarıw kerek. Keyin bas barmaqta saqıynadan alıp, jipti tartıw kerek boladı.

Náwbettegi saqıynalardı toqıwda usı háreket izbe-iz tákirarlanadı. Nátiyjede, toqılatuǵın buyımnıń dáslepki qatarı payda boladı.

Dáslepki qatardı toqıp bolǵannan soń, jumıstı dawam ettiriw ushın bir kegeydi áste suwırıp alamız.

Toqılǵan qatarımız ekinshi kegeyde qaladı.



Oń hám teris ilmeklerdi toqıw

Oń hám teris ilmekler kegeyde toqıwdıń tiykarǵı elementleri esaplanadı. Oń ilmek polotnonıń artqı tárepinde teris ilmek bolıp, teris ilmek bolsa oń bolıp kórinedi. Oń ilmeklerdi toqıwda jip barlıq waqıtta jumıstıń arqa tárepinde jaylasadı. Oń kegeydi ózine qarata shepten ońǵa-shep kegeydegi ilmekke kirgizip, jipti tartıp alamız. Nátiyjede oń kegeyde jańa ilmek payda boladı. Shep kegeyde qalǵan ilmekti túsirip jiberemiz.

Usı usıldan paydalanıp, súwrette kórsetilgenine qarap, óziniń ushın sharf toqıp kóriń.



ILMEK PENEN TOQIW



Ilmek áyyemgi toqıw ásbaplarınan biri. Ilmek penen toqıw burınnan rawajlanǵan qol ónerlerinen biri. Búgingi kúnde de bul qol óneri menen kóp hayal-qızlarımız shuǵıllanadı. Ilmekler metallardan, aǵashtan yamasa plastmassadan tayarlanadı. Olar uzınlıǵı hám qalınlıǵına qarap hár qıylı boladı. Kóbinese metall hám plastmassadan yamasa qattı aǵashtan tayarlanǵan ilmektan qalıń, jumsaq hám elastiklik jiplerden buyımlar toqıwǵa boladı.

Ilmeklerdiń túrleri kóp, olardıń eń jaqsısı súyekten islengen ilmek. Olar bekkem hám tegis boladı. Qalıń jip hám gezeleme ushın aǵashtan islengen ilmekler qollanıladı. Jipek tor toqıwda jıńıshke jipler polattan islengen ilmekler menen toqıladı.

Ilmek penen toqıw usılları

Ilmek oń qolıńızda, jip bolsa shep qolıńızda bolsın. Ilmekti ruchka yamasa qálemdi uslaǵanday uslań. Ilmektiń ushı joqarıǵa da, tómenge de emes, ózińizge qaratılǵan bolıwı kerek. Jipti bolsa súwrette kórsetilgendey etip kórsetkish barmaǵıńızǵa ilip, úlken barmaǵıńız benen kelte buwını, qaptaldaǵı barmaǵıńız benen bolsa jipti uslap turıń. Ilmekti oń qol menen, jipti bolsa shep qoldıń bas hám orta barmaqları menen uslań. Keyin jipti ilmek benen ilip alıp, gúrmek payda etiw

ushın ilmekti aylandırıń. Jip ilmekti orap, saqıyna payda etedi.



Hawa saqıynasın toqıw

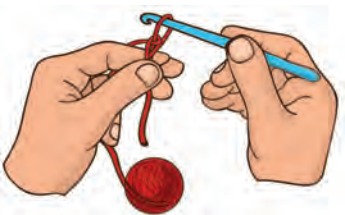

Tiykarǵı saqıynamızdı úlken barmaǵımız benen basıp turıp, jipti ilip alsań, hawa saqıynası payda boladı. Keyin jáne ilmekti kórsetkish barmaǵıńız astındaǵı jipke tıǵıp, bul jipti ilip alıp, onı ilmektegi saqıyna ishinen tartıp shıǵarıń.

Bul ilmek toqıwdıń tiykarǵı háreketleri bolıp esaplanadı. Jumıs barısında jiptiń uzın bólegin kishkene barmaǵıńız benen uslap turıwdı umıtpań. Baslanǵısh saqıynanı jiptiń kelte tárepinen tartıp bekkemlep qoyıw múmkin.



Jumisti stolga qoyin (1). Ilmek jârdeminde jipti aqirgı saqıynadan shıgarıp alin (2).

Toqılmanin eki ushındağı jiplerdi qayshı jârdeminde qıyın (3).

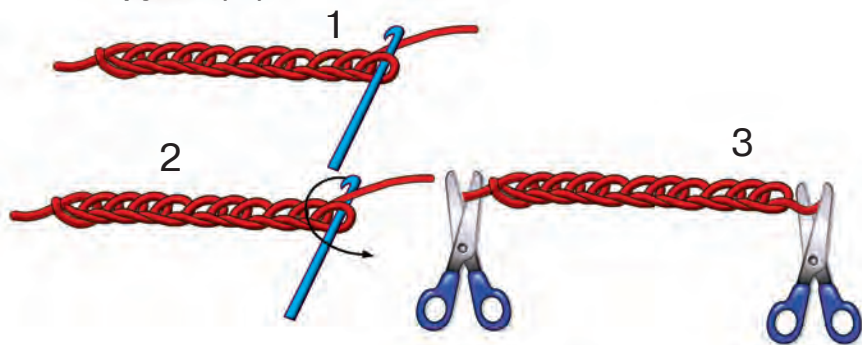

Jipti shınjır târizli kóriniste toqıp alin (1). Shınjır târizli toqılğan jiptin aqirgı tesigine ilmektı tıgın (2). Ilmek penen jipti ilip alin (3). Jipti shınjır hám ilmek ústinen tartin (4,5). Nátiyjede, yarım bađana payda boladı.

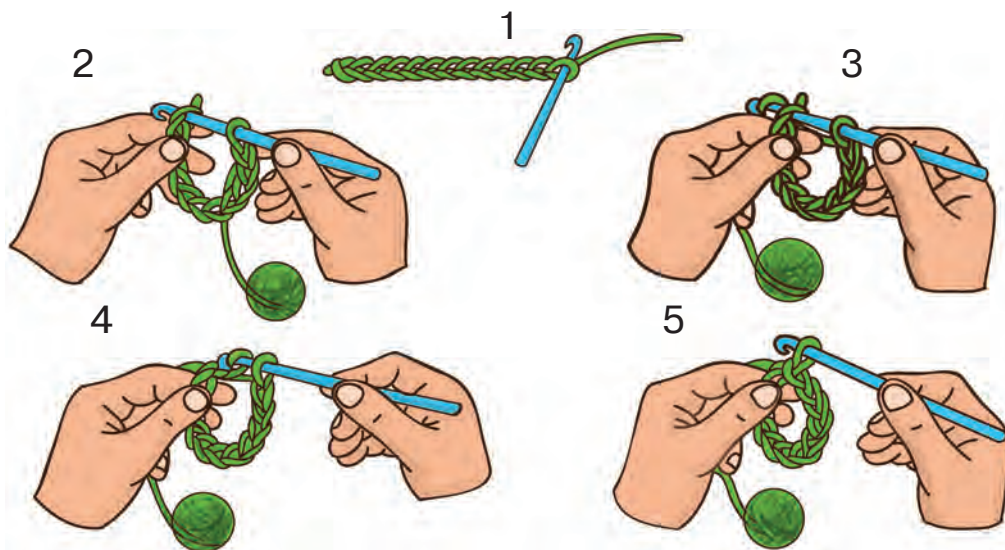

SHÍNJÍR TIGISINEN KOMPOZICIYA ISLEW

Óz qollarıńız benen toqıǵan shıńjır tárizli jiplerińizden paydalanıp, applikaciya usılında hár túrli naǵıslar payda etiń.

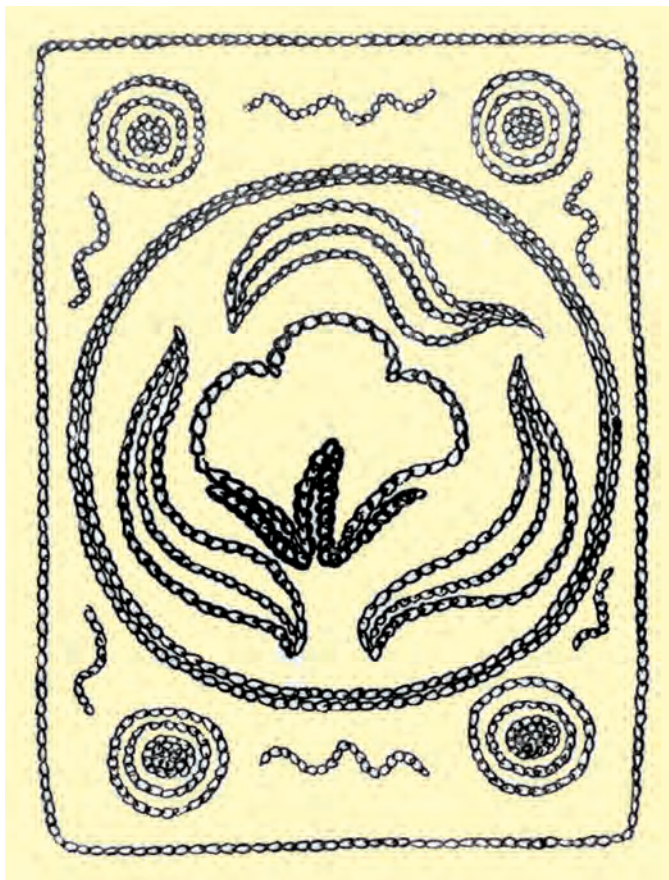

Toqıw ushın qanday ásbaplar kerek boladı? Qanday jip túrлерinen paydalanamız? Qanday zatlardı toqıw múmkin?



Óziñiz óz betñizshe isleñ.



MÁYEK QABÍRSHAĠINAN MOZAIKA USÍLÍNDA KOMPOZICIYA TAYARLAW

Máyek qabırshaġinan anańız benen ámeliy jumıstı islew ushın tayarlap alıń. Kompoziciya dúziw ushın tek shiyki máyek qabırshaġinan paydalanıń. Bunıń ushın máyek qabırshaġın suwǵa salıp qoyıń. Suwǵa bir qasıq duz hám soda salıń. Sonda máyek qabırshaġınıń alınıwı ańsat boladı.



Karton qaǵazǵa súwrettiń súlderin túsirip alamız.



Máyek qabırshaġın kerekli reńler menen boyaymız. Keyin keptiriwge qoyamız. Keptirilgennen keyin onı maydalaymız hám kartonǵa salınǵan súwretke jabıstıramız. Jabıstırıwdı shetten baslaw kerek.



2



3



4



5



DÓRETIWSHILIK PENEN ÓZ BETINSHE ISLEW USHÍN TEMALAR



Almaniń formasın islew

Alma islew ushın sizge kerek boladı: gazeta, jelim, qılqálem, alma, may yamasa vazelin.

Almaǵa may jaǵıp, keyin ızǵar qaǵaz bólekleri-
nen birneshe qatlam etip jabıstırıp shıǵıń.



Payda bolgan formağa jelim jaǵıp, aq qaǵaz jabıstırıń. Keyin gazeta bóleklerin jelimleń. Bul procesti 3 márte tákirarlap ornlań.



Jabıstırıp bolıp, formanı pıshaq penen teń ekige bóliń hám almanı ajratıp alıń. Alma forması bólimlerin jelim menen bir-birine jabıstırıń.



Ústinen guash boyawı menen reń beriń.



QIS KÓRINISIN SÚWRETLEW

Qis kórinisin baqlań. Qista tábiyatta qanday ózgerisler bolıwın súwretlewge háreket etiń. Kórinisti súwretlew ushın eki túrli reńli qaǵazdan tiykar tayarlań hám tereklerdi ekige búklep qıyw kerekligin umıtpań.

Kórinisti aplikaciya usılında islew tártibi izbeizligin qálem menen sanlar jazıw arqalı belgileń.

- qıyń;
- bólimlerin belgileń.
- jabıstırıń;
- bólimlerge jelim jaǵıń.

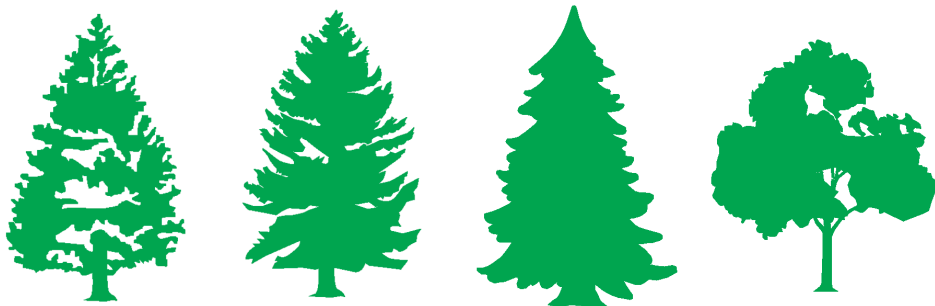



Kólemli aplikaciya usılnan paydalanıp kórinis islew

Kvadrat túrindegi qaǵazdı diagonal sızıqları boyınsha búk- leseńiz, kólem (úsh ólshem) li yolkanıń bir japıraǵı payda boladı. Sonday japıraqtan hár qıylı ólshemde birqansha is- lep alıń hám bir-biriniń ústine jaylastırıp shıǵıń.

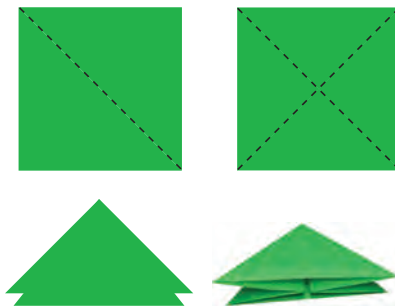

Qoyan soǵıw ushın bolsa úshmúyesh qaǵaz alıń. Ushlı tárepin azǵantay qırqıń hám bir bólegin búkleń. Úshmúyeshliktiń keń tárepin garmoshkaǵa uqsatıp (qatlam-qatlam etip) búkleń hám onı tayar- lap qoyǵan orınǵa jabıstırıń.

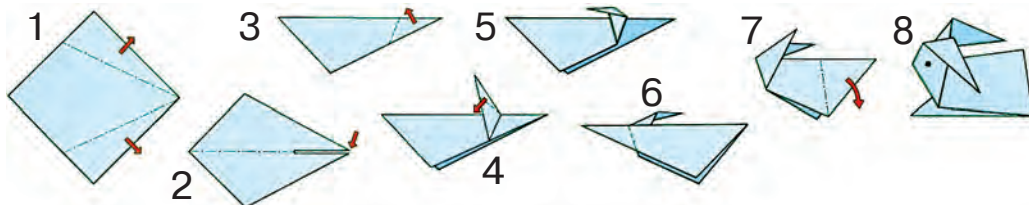

APLIKACIYA USÍLÍNDÁ BÁHÁR KÓRINISIN ISLEW

Sizge kerek boladı: reńli qaǵaz, jelim, qılıqálem, qayshı.

Báhár kórinisin aplikaciya usılında islew ushın úlgi boyınsha kerekli formalardı qıyıp alıń. Súwrette kórsetilgenindey etip jelim menen jabıstırıń.



Ózińiz islep kóriń



QUTLIQLAW SAWĠASÍN TAYARLAW

Doslarınızdı bayram menen qutlıqlaw ushın qutlıqlaw sawġasın isleń.

Súwretke dıqqat penen qarań. Qutlıqlaw sawġasınıń tiykarǵı bólimin qalay tayarlaw múmkin?



Gúl japıraǵı hám japıraq tayarlaw ushın qanday formadaǵı qaǵaz alınadı? Qaǵazǵa qálem menen qanday forma soǵıp alasız?



Gúl japıraqları súwrette qalay jaylasqanlıǵın kórip shıǵıń hám qutlıqlaw sawġasına jaylastırıń.



BAYRAMGA QUTLIQLAW SAWGASIN TAYARLAW

Tuwri tórtmúyesh qaǵazda qutliqlaw sawǵasınıń tiykarǵı bólimin tayarlap alıń.

Aldıńǵı klaslarda gúl tayarlaw jolın esleń hám gúl tayarlań.

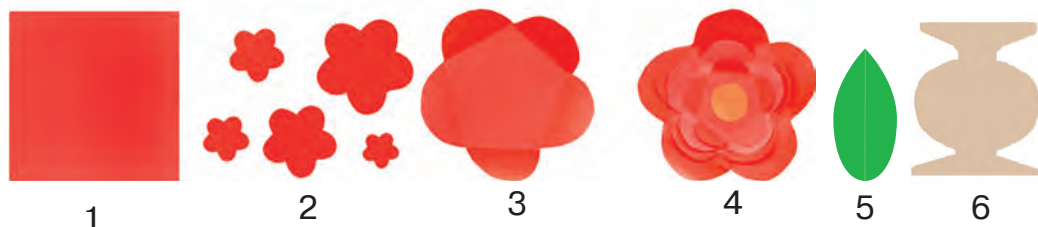

Gúl japıraqların súwretteǵidey búklep shıǵıń hám bir-birin ústine qoyıp jabıstırıń.

Japıraq hám gúzeni qaǵazdı ekige búklep, úlgi tiykarında belgilep alıń hám qıyır.

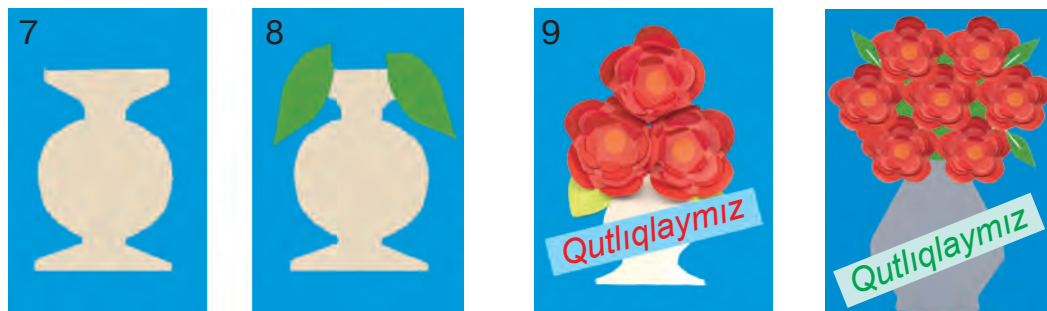

Qutliqlaw sawǵasın tayarlawda birinshi gezekte qaysı formanı jabıstırıwdan baslaysız? Formalardı jabıstırıwda izbe-izlikke ámel etiń.



Tapsırma: Súwrette berilgen gúllerden paydalanıp, jáne qanday qutliqlaw sawǵaların tayarlaw múmkin? Oylań hám islep kóriń.

ÓZIÑIZ QUTLIQLAW SAWĠASÍN ISLEP KÓRIÑ

Qutlıqlaw sawġasınıñ qalay isleniwın esleñ hám doslarıñız benen birge islep kóriñ.

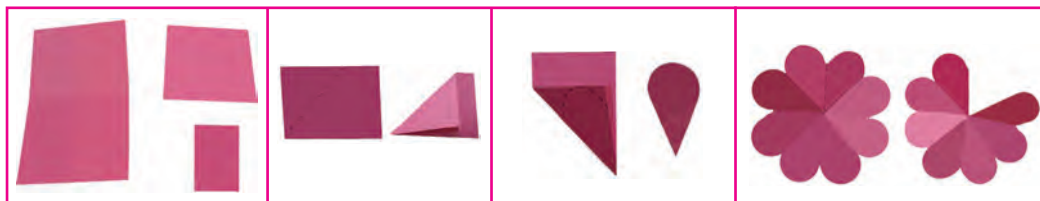

Qanday formadağı qaġaz alınadı hám ol neshe máрте búklenedi? Qalay búklenedi?



Payda bolġan gúl formasınan kólemli gúl formasın payda etiñ. Gúllerdi súwrette belgilengen belgiler tiykarında bir-birine jabıstırıñ.





BAYRAM QUTLIQLAW SAWǴASÍ

Qutlıqlaw sawǵasın islew ushın dáslep onıń tiykarın tayarlap alıń. Eki qıylı ólshemdegi tuwrı tórtmúyeshli qaǵazdı ekige búkleń, oǵan qálem menen súwrettegi sızılmanı sızırń. Keyin sızılma boyınsha qıyrń hám tayar formalardı jabıstırń.



ESLEW HÁM QÁDIRLEW KÚNINE GÚLDÁSTE ISLEW

Aldıngı sabaqlarda ózlestirgen bilimlerińiz tiykarında Eslew hám qádirlew kúnine atap gúldáste isleń.

	<p>Kerekli ásbaplardı tayarlap alıń. Kvadrat formasındaǵı qaǵazdı qıyıp tayarlań.</p>
	<p>Kvadrat formasındaǵı qaǵazdı súwretdegidey qálemge orań.</p>
	<p>Oramdı ortaǵa qarap jıynań. Sonday gúl japıraǵınan 5 in tayarlań.</p>
	<p>5 japıraqtı birgelikte aylandırıp jıynań hám jip penen baylań.</p>
	<p>Usınday gúller payda bolıwı kerek.</p>



Gúl túbegine ga-
zeta yamasa ke-
reksiz qağazdı jay-
lastırıń.



Qağazğa kley ja-
ǵıp, oǵan gúldi ja-
bıstırıń. Kepkenshe
sabır etiń.



SEBET HÁM GÜLLER SOĞIW

Gúldiń formasın islew qanday tártip tiykarında ámelge asırladı? Esleń hám súwretke qarap isleń.

Eki tárepi bir qıylı reńdegi qaǵazǵa úlgi járdeminde gúl formasın sızırń. Gúllerdiń sanı kóp bolıwı ushın qaǵazdı qabat-qabat etip búkleń.

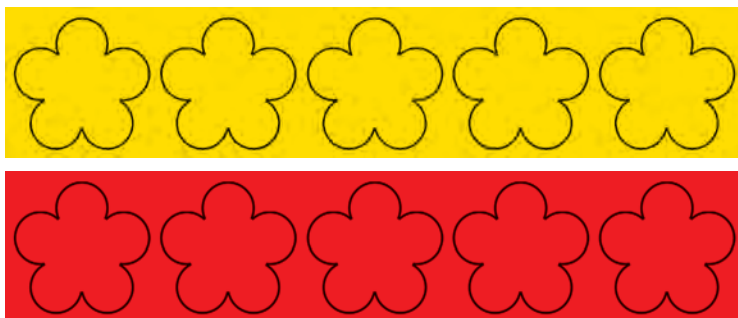

Búklengen gúl formasın abaylap qıyrń. Domalaq formalar islep, gúllerdiń ortasına jabıstırń.

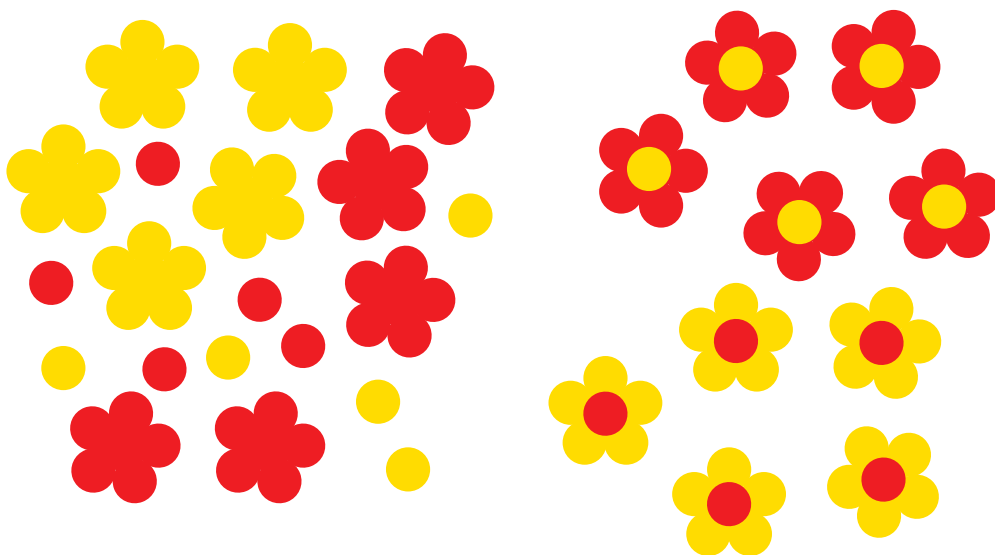

Tuwrı tórtmúyesh qaǵazdı alıp, teń ekige búkleń. Búklengen tárepinen 2 sm qaldırıp, birdey etip qıyıp shıǵırń.



Keyin qıyılmaǵan tárepin orań hám shetin jelim menen jabıstırń. Olardıń arasın ashırń.



Endi shaqalarǵa gúllerdi jelimlep shıǵırń. Mine, sebettegi gúller tayar!





GULDÁSTE ISLEW

Gúldáste islew ushın qaǵazdı búklew jolların eske alıń. Ámellerdiń basqıshpa-basqısh isleniwine itibar berıń hám isleń.



1



2



3



4



5



6



7



8



9



10



11



12



QAĞAZDAN KEPTER ISLEW

Kvadrat formasındaǵı qaǵazdı alıń. Onıń qarama-qarsı ushların birlestiriń hám úshmúyeshlik payda etiń. Úshmúyeshliktiń tómenǵı ushların joqarǵı táreptegi ushlarına birlestiriń hám arqa tárepine burıń.

Qaptal táreptegi ushların orta sızıqqa qarap birlestiriń hám tómenǵı tárepten arasin aşıń.

Súwrette kórsetilgendey etip búklep, iz qaldırıń. Qaldırılǵan izlerdi ishine qaratıp búklew arqalı quyırq hám bas bólimin payda etiń.

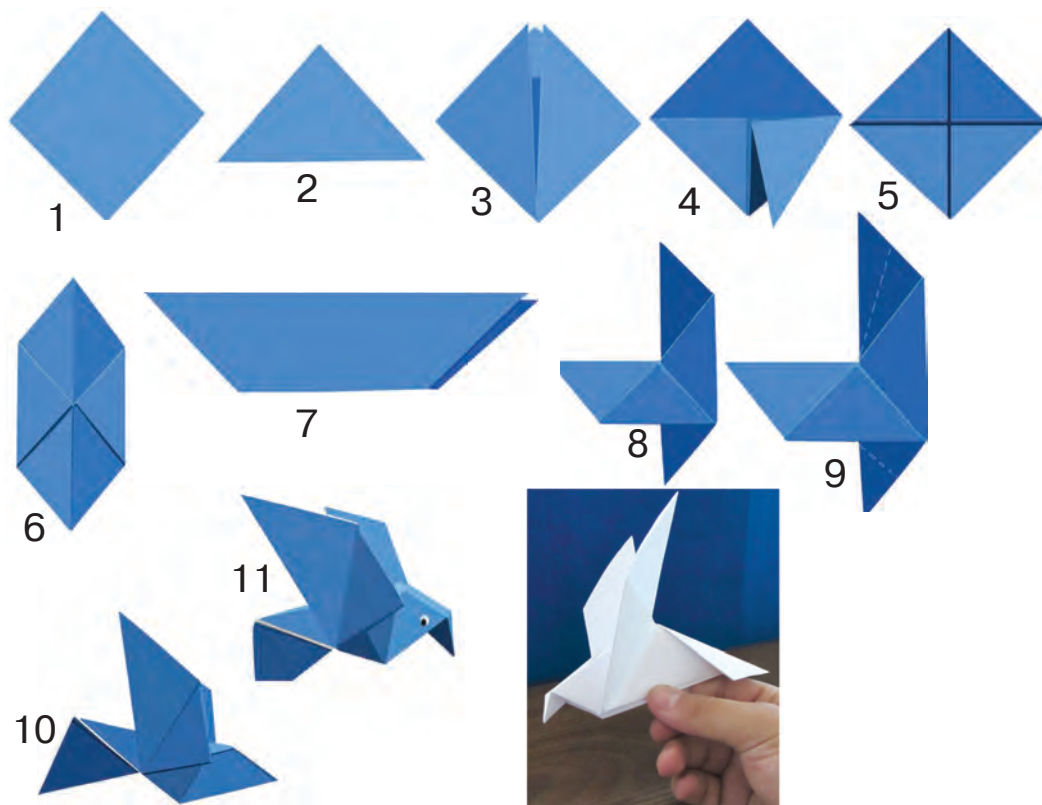

Qağazdı búklew qağıdalarına ámel etip, aqquwdı soǵıwǵa háreket etiń.

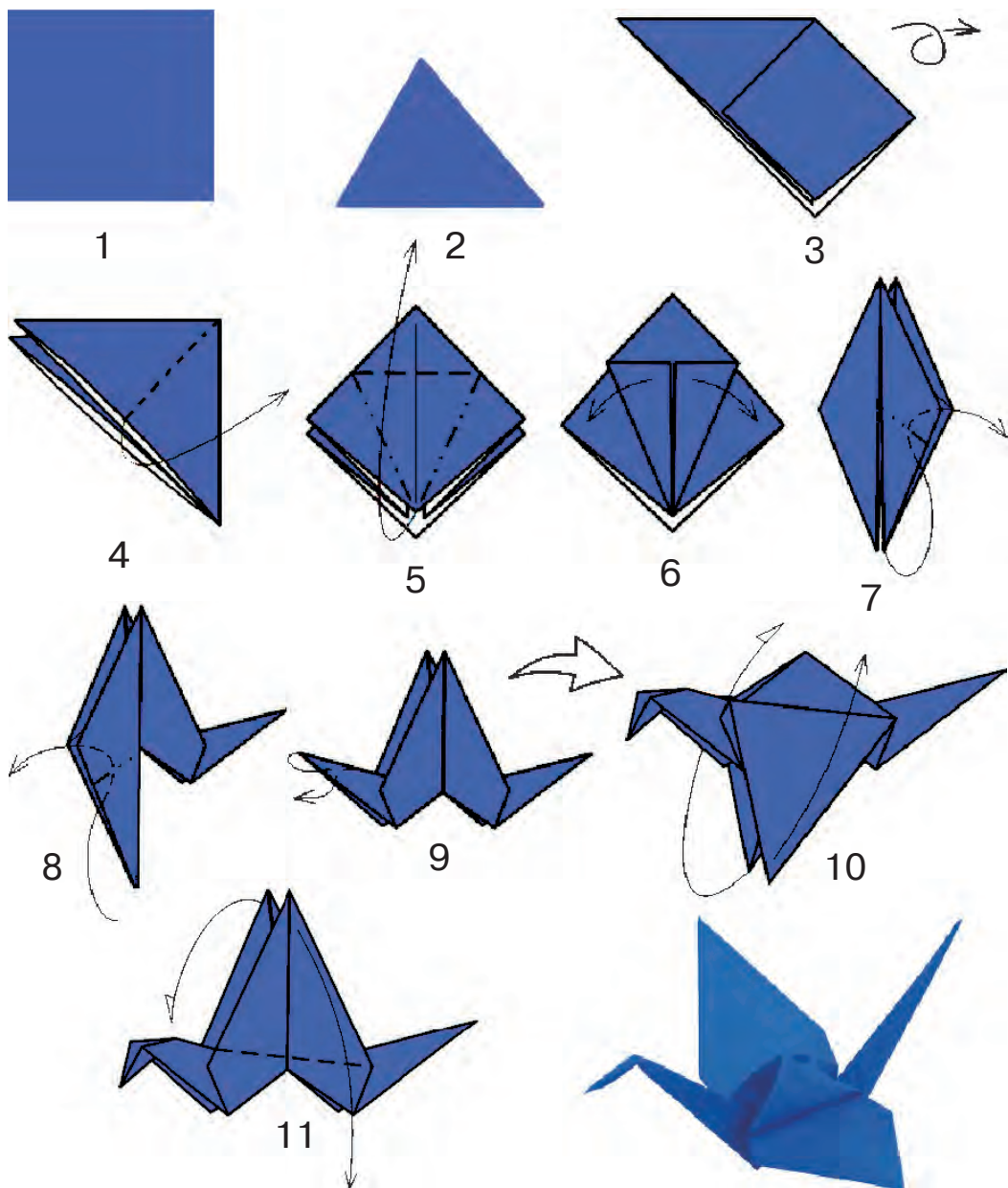

QAĞAZDAN QORAZ ISLEW

Kvadrat qağazdı alıń. Onıń tómeni ushın ortasına qaray búkleń. Kvadrat qağazdıń joqarı tárepindegi ushın ortasına qaray búkleń. Keyingi búklewdi súwrette kórsetilgenindey ámelge asırıń.

Payda bolǵan formanı ekiye búkleń, soń súwrette sızılǵan sızıqlar boyınsha iz qaldırıp búkleń. Búklengen jerinen arasin ashıp jaylastırsańız, qorazdıń bas bólimi payda boladı. Quyırq bólimin de usı usılda isleń.

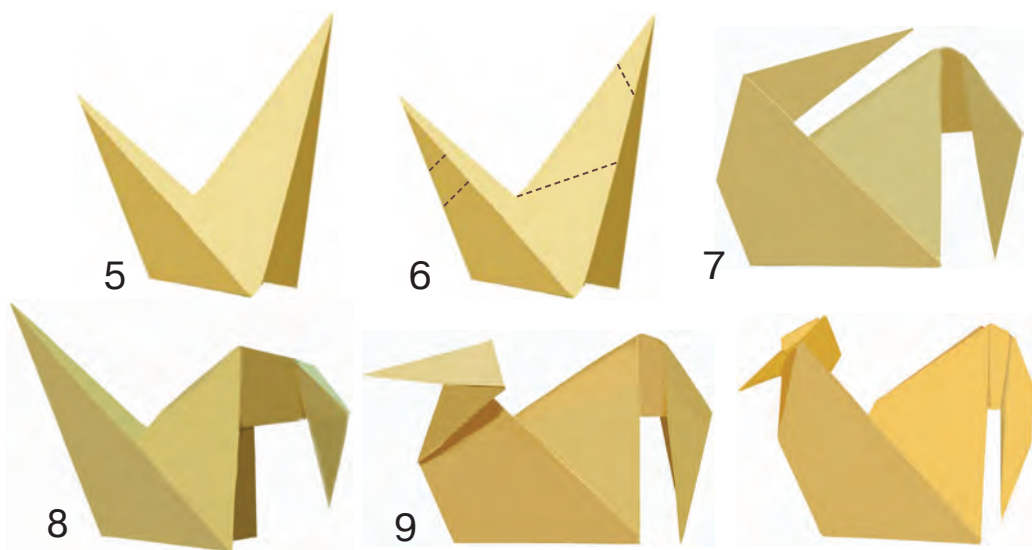
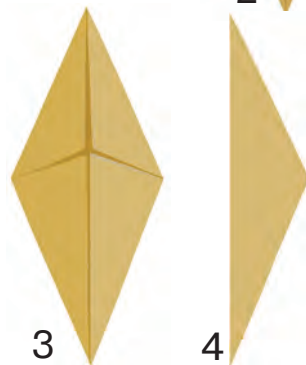
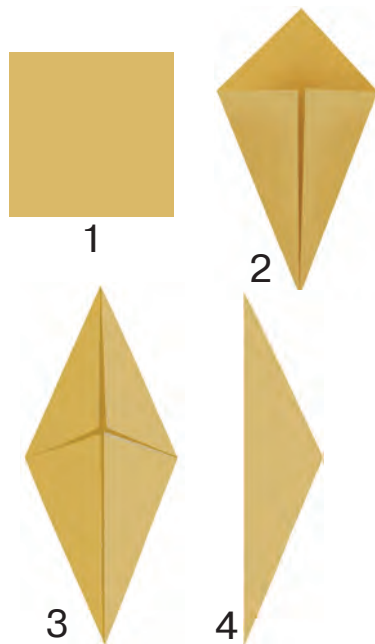

QUS PALAPANÍN TOQÍW

Shımshıqtırn palapanın toqıw ushın jumıstı hawa saqıynası payda etiwden baslań. 10 — 12 ilmek toqırn (1). Yarım baǵana toqırn (2 — 3).

Shınjırdan saqıyna payda boldı. Jáne 10 ilmek toqırn (4). Birinshi saqıynanıń qasına ekinshi yarım baǵanasın toqırn (5 — 6). Eki saqıyna payda boldı. Usı tárizde toqıwdı dawam ettiriń. Hawa saqıynasınan domalaq formalar payda boladı. Eki monshaqtı tigiń (bul palapannıń kózleri boladı). Reńli qaǵazdan tumsıǵı hám pánjelerin qıyıp jabıstırnı.

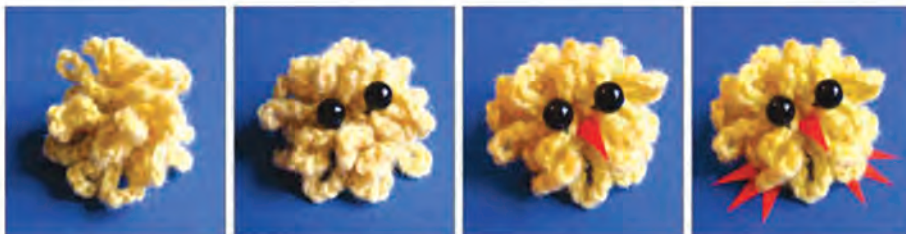
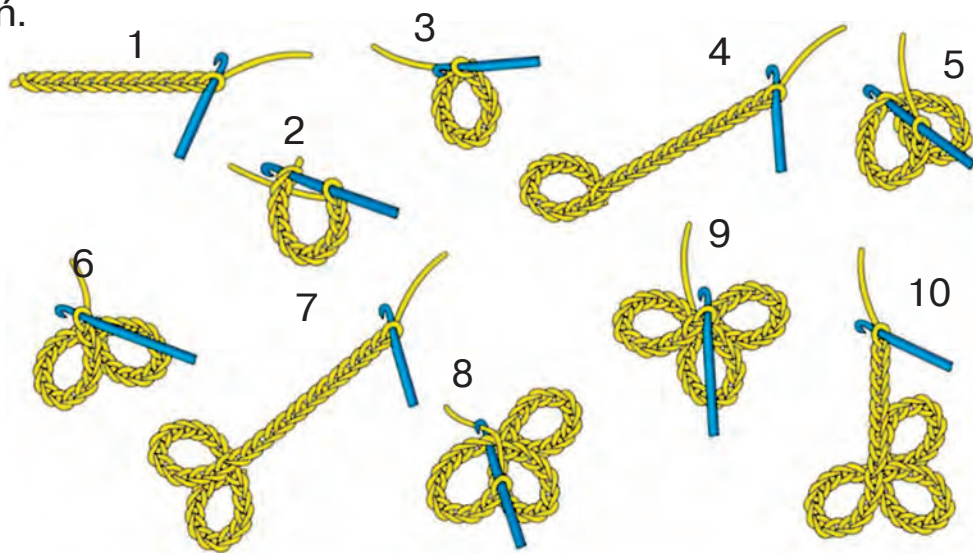

TEXNOLOGIYA SABAĞINA TIYISLI ATAMALAR TÚSINDIRMESÍ

Karton — arnawlı islengen qalıń, qattı qaǵaz.

Mulina — keste tigiw ushın qollanılatuǵın reńli sabaqlar.

Penoplast — plastmassanıń jeńil kóbik tárizli túri. Tiykarınan aq reńde boladı.

Materiallar — qanday da bir maqset ushın kerikli shiyki zat, zat. Islewde qollanılatuǵın tiykarǵı materiallar: qaǵaz, gezleme, aǵash, plastmassa, metall h.b.

Ólshew — ólshew ásbabı quralı menen zattıń uzınlıǵı, ólshemin belgilew degen sóz. Buyımlardı ólshewde, tiykarınan, onıń biyikligi, eni hám uzınlıǵı itibarǵa alınadı hám uzınlıq birlikleri (santimetr, milimetr)nen paydalanıladı.

Birlestiriw — buyım bóleklerin bir-birine jabıstırıw.

Forma — buyımınń ústingi kórinisi. Buyımlar kólemli hám tegis kóriniste boladı. Olardıń kórinisi tuwrı tórtmúyeshlik, shar tárizli, tuwrı hám iymek formasında bolıwı múmkin.

Origami — qaǵazdı búklep, forma islew usılı.

Kegey (spica) — toqıw ushın qollanılatuǵın ásbap.

Pape-mashe — qaǵazdı bóklep jabıstırıw jol menen zat-buyımlar islew usılı.

Kvilling — uzınsha hám ensiz qaǵazdı esiw usılı menen shıraylı hám názik buyımlardı islew usılı.

MAZMUNÍ

KIRISIW.....	3
QAĞAZDÍ BÚKLEW USÍLLARÍ	10
KÚSHIK ISLEW	12
QAĞAZDAN SPORT AVTOMOBIL MODELIN ISLEW	14
TÁBIYIY MATERIALLARDAN APPLIKACIYA USÍLÍNDÁ GÚL ISLEW	16
GÚL ISLEW	19
GÚZGI JAPÍRAQLARDAN GÚL ISLEW	20
ASXANA BUYÍMLARÍ MENEN TANÍSTÍRÍW HÁM ISLEW	21
ÚY-RUWZÍGERSHILIK BUYÍMLARÍ MENEN TANÍSTÍRÍW HÁM ISLEW	23
ASPAZLÍQTA TAYARLANATUĞÍN QAMÍR TÚRLERİ.....	29
QAĞAZDAN PELMEN ISLEW	31
QAĞAZDAN PAPE-MASHE USÍLÍNDÁ BUYÍMLAR ISLEW	32
SABANNAN KÓLEMLI OYÍNSHÍQLAR ISLEW	35
SABANNAN APPLIKACIYA USÍLÍNDÁ PEYZAJ TAYARLAW	40
SUWDA JÚZETUĞÍN TRANSPORT ISLEW (KATAMARAN).....	42
QÍZÍL JELQOMLÍ KEME ISLEW	44
USHÍWSHÍ MODELIN ISLEW	45
POLIMER MATERIALLARDAN OYÍNSHÍQ ISLEW	47
AYAZBABA USTAXANASÍNDÁ YOLKA BEZEGIN ISLEW	48
YOLKANÍ BEZEW USHÍN MARJAN ISLEW	49
SHAR FORMASÍNDÁĞÍ YOLKA OYÍNSHÍGÍN ISLEW	50
QAĞAZDAN YOLKA ISLEW.....	51
QUTLÍQLAW SAWĞASÍN ISLEW	52
ERTEK QAHARMANLARÍN ISLEW	53

PLASTILINNEN SEBET KÓTERGEN TÚLKI ISLEW	56
JIPTEN OYÍNSHÍQ ISLEW	57
JIPTEN SEGIZAYAQ ISLEW	58
GEZLEMEDEN JUMSAQ OYÍNSHÍQ TIGIW	60
BEZELGEN OYÍNSHÍQ KÓPSHIK TIGIW	62
OYÍNSHÍQ TIGIW	63
JÚK MASHINASÍ MODELIN ISLEW	64
AVTOMOBIL MODELIN ISLEW	65
8-MART BAYRAMÍNA QUTLÍQLAW SAWĠASÍ	66
BAYRAM QUTLÍQLAW SAWĠASÍN ISLEW	68
NAWRÍZ BAYRAMÍNA QUTLÍQLAW SAWĠASÍN ISLEW	70
“GULZAR” KÓRINISLI KVILLING USÍLÍNDÁ ISLEW	72
TIGIWSHILIK.....	73
GEZLEMEDEN ZATLAR TIGIW	74
GEZLEMEDEN GÚL DÁSTESIN ISLEW.....	76
TOQÍW HAQQÍNDÁ MAĠLÍWMAT.....	78
ILMEK PENEN TOQÍW	81
SHÍNJÍR TIGISINEN KOMPOZICIYA ISLEW	84
MÁYEK QABÍRSHAĠÍNAN MOZAIKA USÍLÍNDÁ KOMPOZICIYA TAYARLAW	86
DÓRETIWSHILIK PENEN ÓZ BETINSHE ISLEW USHÍN TEMALAR	88
TEXNOLOGIYA SABÁĠÍNA TIYISLI ATAMALAR TÚSINDIRMESI	108

O'quv nashri

Mannopova Ilgizar Axmadovna
Mavlonova Rahima Abdurazzoqovna
Ibragimova Nazokat Ravshanxonovna

TEXNOLOGIYA

4-sinf uchun darslik

(Qoraqalpoq tilida)

Qayta ishlangan va to'ldirilgan
ikkinchi nashri

«O'zbekiston milliy ensiklopediyasi»
Davlat ilmiy nashriyoti
Toshkent – 2017

Awdarmashi	Z. Óserbaeva
Redaktor	S. Aytmuratova
Dizayner	A. Yoqubjonov
Xudojnik	J. Badalov
Tex. redaktor	U. Sapayev, B. Turimbetov
Operator	A. Ataǵullaeva

Baspa licenziyası AI № 160, 14.08.2009-y.
24.07.2017-j.da basiwǵa ruqsat etildi. Formatı 70 x 90 ¹/₁₆.
Kegli 14. Ofset usılında basıldı. Shártli baspa tabaq 8,19. Esap b.t. 7,00.
Nusqası 11062 nusqa. 17-229-sanli buyırtpa.

«O'zbekiston milliy ensiklopediyasi» Mámleketlik ilimiy baspası,
Tashkent–100011, Nawayı kóshesi, 30-úy.

Ózbekistan Baspasóz hám xabar agentliginiń
“O'zbekiston” baspa-poligrafıyalıq dóretiwshilik úyi baspaxanasında basıldı.
Tashkent, 700194, Yangishahar kóshesi, 1-úy.

Ijarağa berilgen sabaqlıqtıń jaǵdayın kórsetiwshi keste

T.s	Oqıwshınıń atı Ákesiniń atı	Oqıw jılı	Sabaqlıqtıń alıńandaǵı jaǵdayı	Klass basshısınıń qolı	Sabaqlıqtıń tapsırılǵandaǵı jaǵdayı	Klass basshı- sınıń qolı
1						
2						
3						
4						
5						

Sabaqlıq ijararaǵa berilip, oqıw jılı aqırında qaytarıp alıńanda joqarıdaǵı keste klass basshısı tárepinen tómendegi bahalaw ólshemlerine tiykarlanıp toltırıladı:

Jańa	Sabaqlıqtıń birinshi ret paydalanıwǵa berilgendegi jaǵdayı
Jaqsı	Muqabası pütün, sabaqlıqtıń tiykarǵı bóliminen ajralmaǵan. Barlıq betleri bar. Jırtılmaǵan, betleri almastrılmaǵan, betlerinde jazıw hám sıziqlar joq.
Qanaatlandırarlı	Muqaba jelingen, bir qansha sızılıp, shetleri qayırılǵan, sabaqlıqtıń tiykarǵı bóliminen alınıp qalıw jaǵdayı bar, paydalanıwshı tárepinen qanaatlanarlı qalıpine keltirilgen. Alınǵan betleri qayta jelimlengen, ayırım betlerine sızilǵan.
Qanaatlanarsız	Muqabaǵa sızilǵan, jırtılǵan, tiykarǵı bólimnen ajralǵan yamasa pútkilley joq. Betleri jırtılǵan, betleri tolıq emes, sızıp, boyap taslanǵan. Sabaqlıqtı qayta tiklew múmkin emes.