

Kids' English 1

O'zbekiston Respublikasi Xalq ta'limi vazirligi
tomonidan tasdiqlangan

Qayta ishlangan oltinchi nashr



TOSHKENT
«O'ZBEKISTON»
2018

UO'K 811.111(075)
+ 811.111(072)
KBK 81.2Ingl
K 40

Mualliflar:

**M. Irisqulov, S. Xan, L. Kamalova, L. Jo'rayev, K. Inogamova,
N. Hakimxodjayev, O. Kartavsova, D. Yusupova, M. Qayumova**

Mualliflar ushbu o'quv-metodik majmuaning yaratilishida ko'rsatgan beminnat yordamlari va bergan qimmatli maslahatlari uchun Britaniya Kengashi direktori S. Maknaltiga hamda RTM xorijiy tillar bo'limi ingliz tili metodistlariga o'z minnatdorchiliklarini izhor etadilar.

O'quv-metodik majmuani sinovdan o'tkazishda ishtirok etgan respublikamizning barcha maktab o'qituvchilari va o'quvchilariga hamda mazkur majmua bo'yicha 1-sinf o'qituvchilarini tayyorlashda ishtirok etgan trenerlarga, shuningdek, Buyuk Britaniya Norvidj til o'rgatish instituti akademik direktori Rod Bolaytoga, IATEFL vakili Les Kirkxemga, Britaniya Kengashi loyiha bosh menejeri Natalya Sarikovaga hamda boshqa taqrizchilarga alohida tashakkur bildiradilar.

Mazkur o'quv-metodik majmua 1-sinf o'quvchilariga o'qituvchi va ota-onalar ortidan matnini takrorlash, o'yinlarni qo'llash va rasmlarni bo'yash yordamida ingliz tilini o'qitishga mo'ljallangan. Ushbu majmua o'qish va yozishni o'rgatishni ko'zda tutmaydi.

Respublika maqsadli kitob jamg'armasi mablag'lari hisobidan chop etildi.

K 40 Kids' English: o'quv nashri. Class 1/A. Irisqulov [va boshq]. – Toshkent: «O'zbekiston», 2018. – 104 b.
1. Irisqulov A.

ISBN 978-9943-01-960-7 (alohida nashr)
ISBN 978-9943-01-781-8

UO'K 811.111(075)
+811.111(072)
KBK 81.2Ingl

O'quv nashri

**Muhamadavas Irisqulov, Svetlana Xan, Lyudmila Kamalova, Lutfullo Jo'rayev, Klara Inogamova,
Nodir Hakimxodjayev, Olga Kartavsova, Dilrabo Yusupova, Munavvar Qayumova**

Kids' English 1

Qayta ishlangan oltinchi nashr

Umumiy o'rta ta'lim maktablarining 1-sinfi uchun darslik

Rassomlar: *I. Xolxo'jayev, F. Iskandarov, R. Zufarov, S. Abdumo'minova, V. Xalilova,
G. Shoabdurahimova, M. Vorobyova;*
Badiiy muharrir *Sh. Xo'jayev*
Muharrirlar: *K. Inogamova, J. Karamatov*
Texnik muharrir *T. Xaritonova*
Musahhah *S. Salohutdinova*
Sahifalovchi va dizayner *A. Sulaymonov*

Nashriyot litsenziyasi AI № 158, 14.08.2009.

Bosishga 2018-yil 29-martda ruxsat etildi. Qog'oz o'lchami 60x90¹/₈.
Ofset qog'oz. «Arial» garniturada ofset usulida bosildi. Shartli bosma tabog'i 13,0.
Nashr tabog'i 16,47. Adadi 482 431 nusxa. Buyurtma № 18-165.

O'zbekiston Matbuot va axborot agentligining
«O'zbekiston» nashriyot-matbaa ijodiy uyi. 100011, Toshkent, Navoiy ko'chasi, 30.
Telefon: (371) 244-87-55, 244-87-20. Faks: (371) 244-37-81, 244-38-10.
e-mail: uzbekistan@iptd-uzbekistan.uz, www.iptd-uzbekistan.uz

ISBN 978-9943-01-960-7 (alohida nashr)
ISBN 978-9943-01-781-8

© M. Irisqulov va boshq., 2018
© «O'ZBEKISTON» NMIU, 2013–2018

Aziz o'qituvchilar va ota-onalar!

Kids' English o'quv-metodik majmuasi sizning e'tiboringizga havola etilmoqda!

Ushbu o'quv-metodik majmua O'zbekiston Respublikasi Prezidentining 2012-yil 10-dekabrda «Chet tillarni o'rganish tizimini yanada takomillashtirish chora-tadbirlari to'g'risida»gi PQ-1875-sonli qarorida belgilangan yangicha talablar va vazifalardan kelib chiqqan holda o'quvchilarga alifboni o'rgatmasdan turib ingliz tilini o'rgatish eng zamonaviy, eng ilg'or pedagogik texnologiyalar hamda metodlar prinsipi asosida yaratildi. Shu o'rinda hukumatimiz tomonidan olg'a surilayotgan, alifboni o'rgatmagan holda ingliz tilini butun bir kurs davomida o'rgatish usuli jahon amaliyotida hali misli ko'rilmagan yangicha bir yondashuv ekanligini alohida ta'kidlab o'tishimiz joiz.

O'quv-metodik majmua Darslik, Multimedia ilovasi hamda O'qituvchi uchun metodik qo'llanmalardan iborat bo'lib, ular yaxlit bir holda 1-sinfga endigina qadam qo'ygan jaji bolajonlarning ingliz tilida ilk saboq olishlariga baholi qudrat yordam beradigan ko'pdan ko'p qiziq va ajoyib mashqlar, o'yinlar, she'rlar, qo'shiqlar va sh.k.larni o'z ichiga olgan. Ularni bolajonlarimizga maqsadga muvofiq ravishda yetkazishda, albatta, Siz aziz murabbiylar va muhtaram ota-onalarning hissasi beqiyosdir.

Farzandlarimiz ingliz tili dunyosiga qiziqarli sayohatni boshlamoqda. Bu sayohat qiziqarli, tushunarli va omadli bo'lishi uchun ularga sizning yordamingiz kerak bo'ladi. Har bir darsdan keyin o'tilgan darslarni mustahkamlash uchun uy vazifalari beriladi. Farzandingizga darsda o'tilgan mavzularni bajarishiga va uni eslashiga yordam bering. Agar u o'tilgan mavzudagi so'zlarni va iboralarni eslay olmasa, xavotirga tushmang. Ularni keyingi safar aytib berishi mumkin. Hamma so'zlar va iboralar darsma-dars takrorlanadi va farzandingiz vaqt o'tishi bilan ularni eslab qoladi. Eng asosiysi, buning uchun hammamizga tirishqoqlik va sabr-toqat kerak bo'ladi.

1-sinf davomida o'qish va yozuvsiz ingliz tilini o'rgatish usuli mamlakatimiz, qolaversa, butun dunyo til o'qitish tarixida yangilik bo'lganligi tufayli, u ayrim kamchiliklardan xoli emasligi tabiiy. Shu bois, o'quv-metodik majmua yuzasidan bildiradigan fikrlaringiz biz mualliflar uchun qimmatlidir.

O'quv-metodik majmua bolajonlarni zeriktirib qo'ymaydi, aksincha, ingliz tilini o'rganishga ishtiyoq uyg'otish bilan bir qatorda olam-olam quvonch ham bag'ishlaydi degan umiddamiz.

Mualliflar

Shartli belgilar:



– tinglab tushunish yoki video mashqlarni bajarish;



– o'yin tarzidagi mashqlarni bajarish;



– kuchli o'quvchilar yoki sinflar uchun qo'shimcha topshiriq;



– o'quvchilarni jonlantirishga mo'ljallangan jismoniy mashqlar;



– asosan, uyda rasmlarni chizish, bo'yash va h.k.lar uchun mo'ljallangan topshiriqlar.

Unit 1 Greetings

Lesson 1 Hello. My name's Zumrad.

1  Listen and repeat.

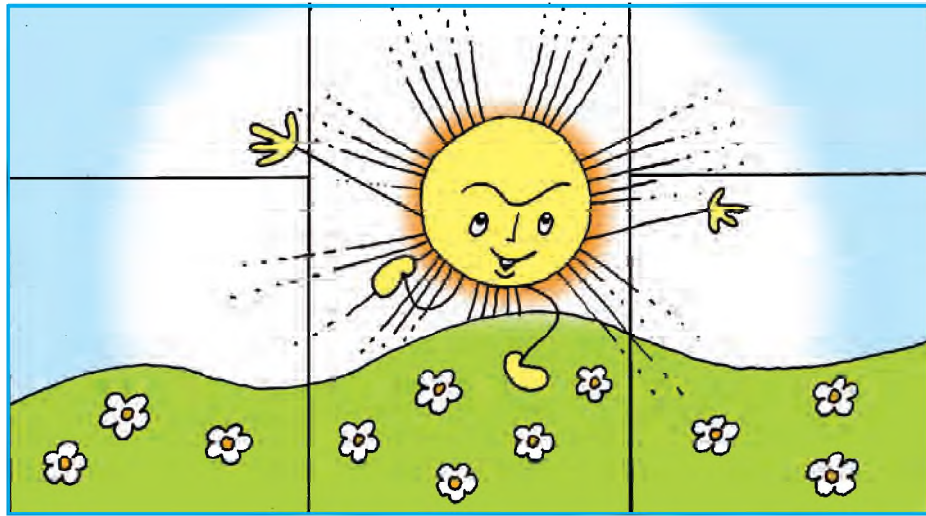

2  Listen and sing.

3a  Look and repeat.



3b Listen and say.

4  Play "Ask and answer".

5  Listen and sing.

Unit 1 Greetings

Lesson 1 Hello. My name's Zumrad.

Ota-onalar uchun

1-uy vazifasi: Farzandingizdan tong rasmini bo'yashni tugallashini va „Good morning“ (Xayrli tong) deb aytishini so'rang. Agar farzandingiz bu salomlashuvni eslab qololmasa, buning hechqisi yo'q. Mazkur salomlashuv to'rt dars davomida ashula tarkibida takrorlanadi va farzandingizda uni yodlab olish uchun yetarli imkoniyat bo'ladi.

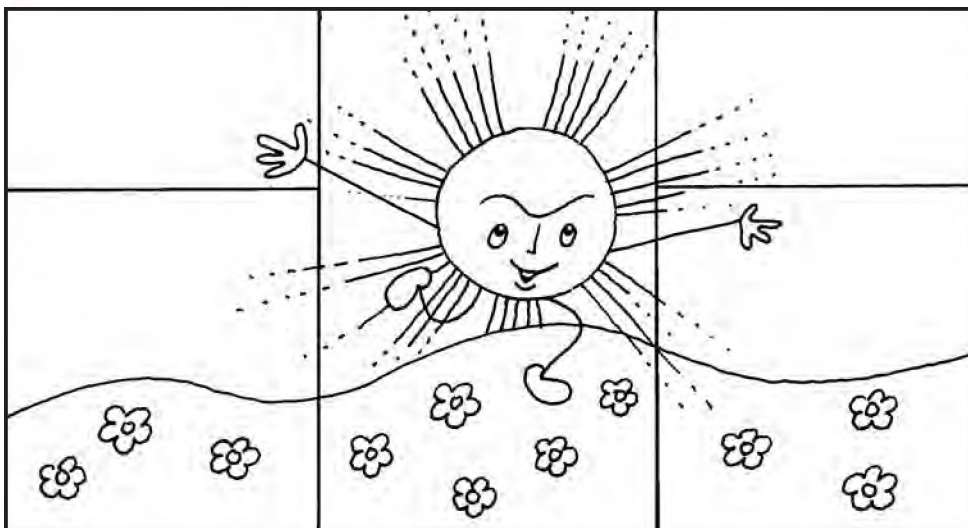

2-uy vazifasi: Farzandingizning o'z rasmini chizishiga yordam bering. Agar farzandingiz rasm chizishni yoqtirmasa, u rasm chizish o'rniga o'z fotosuratini yelimlab qo'yishi mumkin. Farzandingizga „Salom. Mening ismim ...“ (Hello. My name's ...) deb ingliz tilida aytishiga yordam bering.

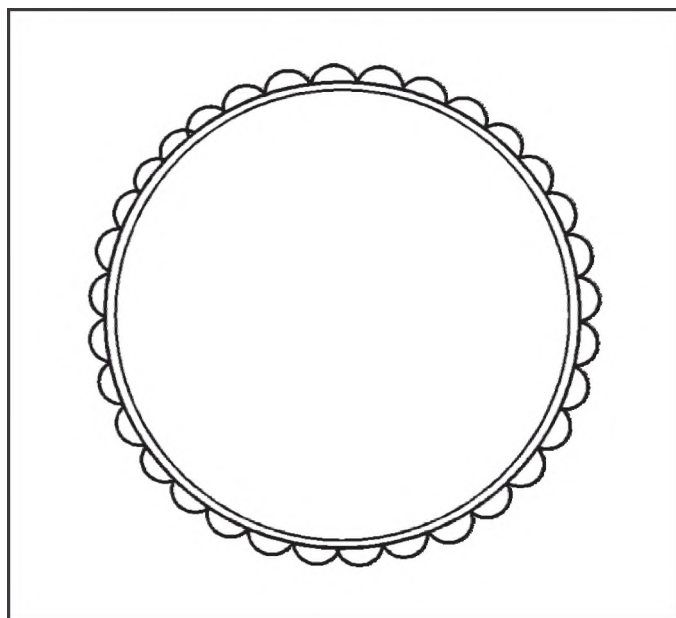

Eslatma: Rasmlar chaplashib ketmasligi uchun barcha uy vazifasiga berilgan rasmlar rangli qalamlarda bo'yalsa, maqsadga muvofiq bo'ladi.

Unit 1 Greetings

Lesson 2 How are you?

1  Listen and repeat.

2 Listen and repeat.

3  Play "Ask and answer".



4   Watch and do.

5 Listen and repeat.

6  Watch and repeat.

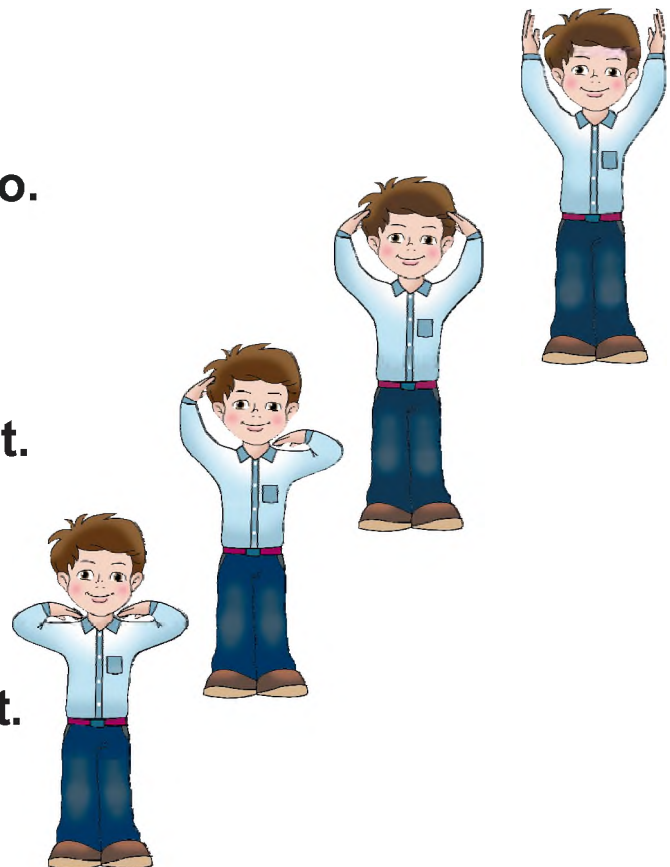

Unit 1 Greetings

Lesson 2 How are you?

Ota-onalar uchun

Uy vazifasi: Farzandingizga rasmni bo'yashda yordam bering. Odamlar bir-birlari bilan salomlashganda hamda hol-ahvol so'rashganda qanday iboralarni ishlatishlarini eslashiga yordam bering. "How are you?" (Qalaysiz? /Ahvotingiz yaxshimi?) savoliga javob berishini so'rang.

OK. / Good. / Great. / So-so. (Yaxshi. / Men yaxshiman. / Zo'r. / Bo'ladi.) javoblarini aytishiga qo'l harakatlaringiz bilan yordam bering.







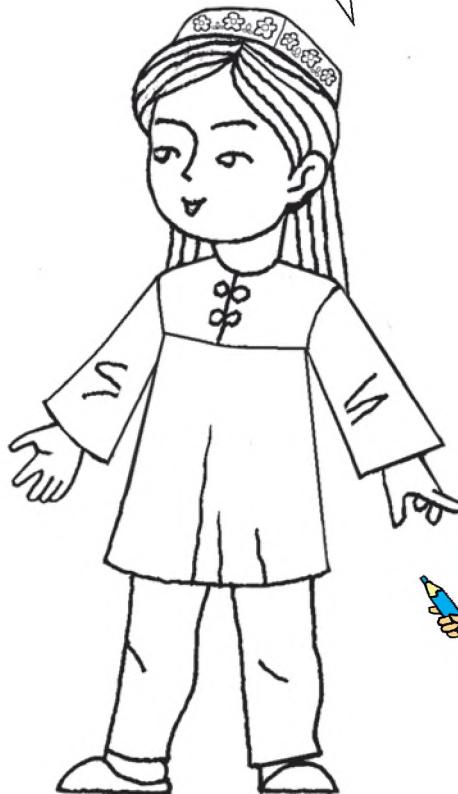
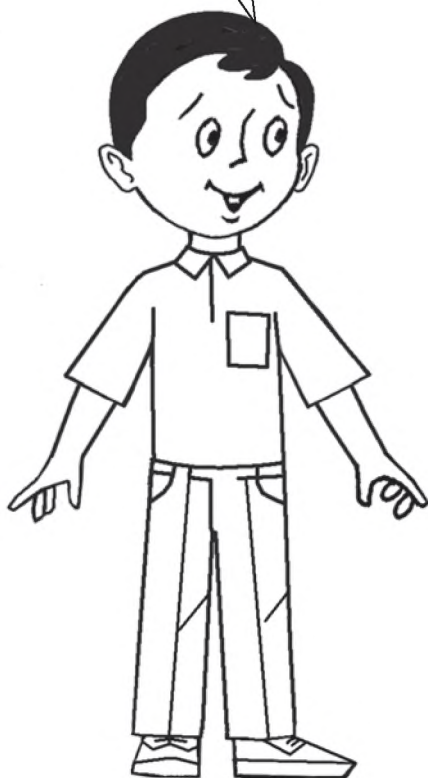

How are you?

OK.



Unit 1 Greetings

Lesson 3 Where are you from?

- 1  Listen and sing.
- 2  Play "Ask and answer".
- 3  Look and do.
- 4  Look, listen and repeat.
- 5  Look, listen and guess.
- 6  Play "Ask and answer".

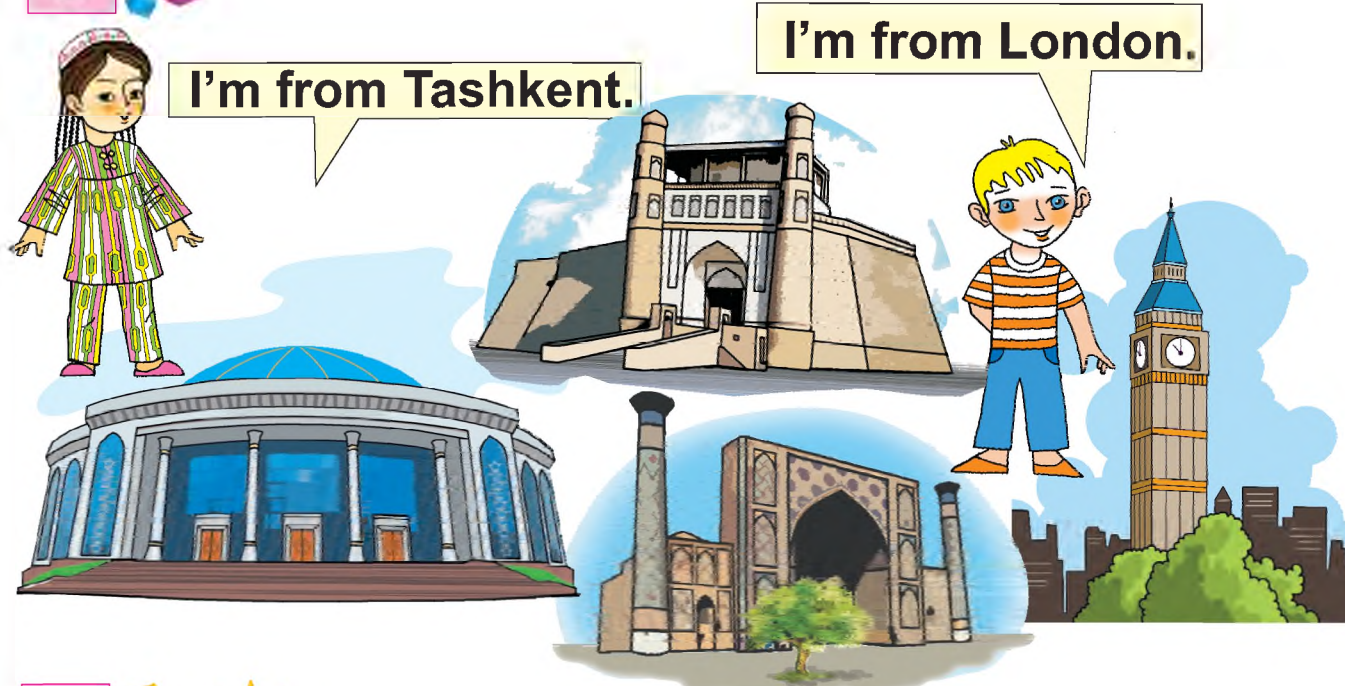

- 7   Play "What's your name?"

Ota-onalar uchun

1-uy vazifasi: Farzandingizdan 6-mashqdagi rasmlarga qarashni va "Where are you from? (Qayerdansen?) savoli hamda "I'm from ..." (Men ... danman./Men ... da yashayman.) javobini eslashini so'rang.

2-uy vazifasi 10-betda joylashgan.

Unit 1 Greetings

Lesson 4 Let's play!

1 Listen and sing.



2 Play "Questions".



3 Play "Interview".



4 Play "Little frog".



5 Play "Look and count".

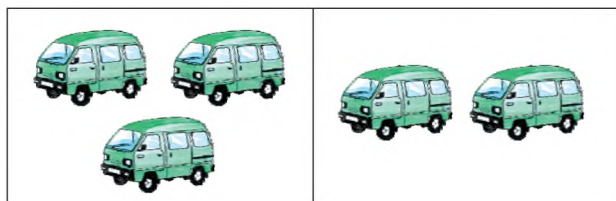
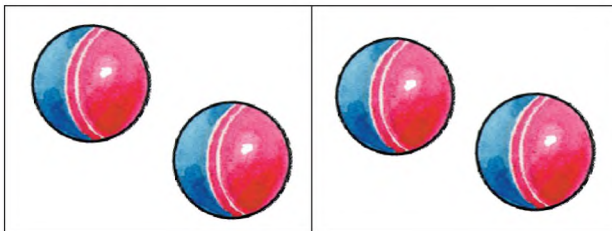
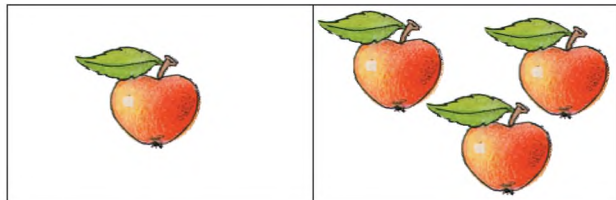

6 Play "Guess the number".



Unit 1 Greetings

Lesson 3 Where are you from?

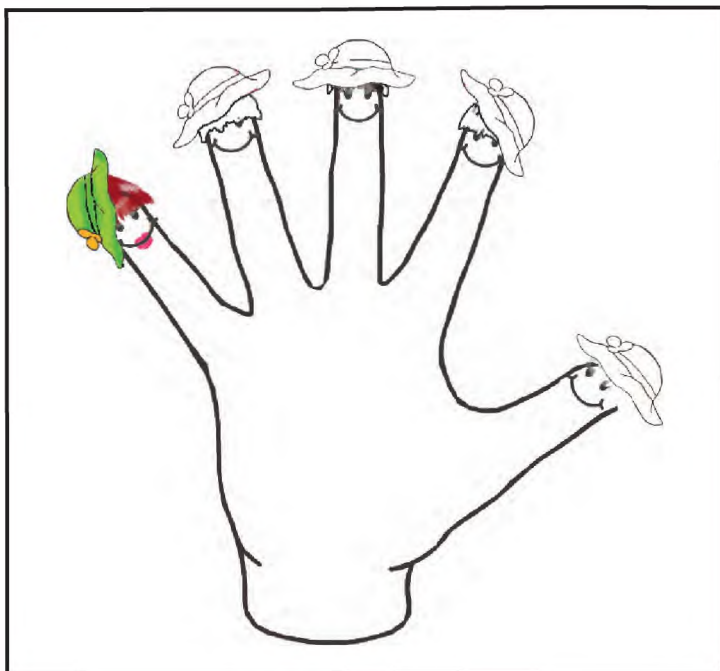

Ota-onalar uchun

2-uy vazifasi: Farzandingizdan rasmni bo'yashni, barmoqlar uchun nom topishni va ular nomidan "What's your name?", "My name's ..." deb aytishni so'rang.

Lesson 4 Let's play!

Uy vazifasi: Farzandingizga rasmdagi narsalarning sonini sanashini hamda raqamlar bilan rasmlarni birlashtirishi kerakligini ayting. "Intervyu" olish o'yini davomida sinfda berilgan savollarni eslashiga yordam bering. Bu o'yin davomida o'quvchilar bir-birlariga quyidagi savollarni berishgan.

Savol: What's your name? (Sening isming nima?)

Javob: My name's ...

Savol: Where are you from?

Javob: I'm from ...

Savol: How are you?

Javob: OK / Good / Great / So-so.



3

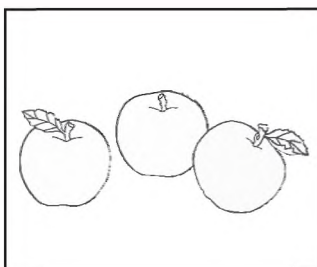

1

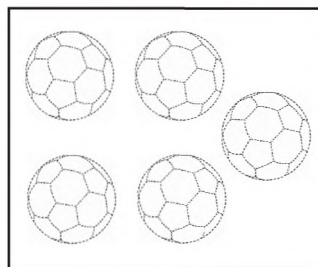

2

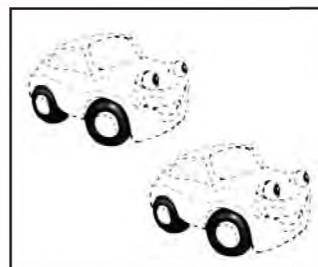

5

Unit 2 I'm in class 1.

Lesson 1 It's a pen.

1  Listen and repeat.

2  Play "Interview".

3 Look, listen and repeat.



4  Look and do.

5   Play "Yes./No."



6    Watch and play.

Unit 2 I'm in class 1.

Lesson 2 How old are you?

1 Listen and repeat.



2 Look and count.

3 Play "Ask and answer"



4 Play "Interview".



5 Look, listen and repeat.

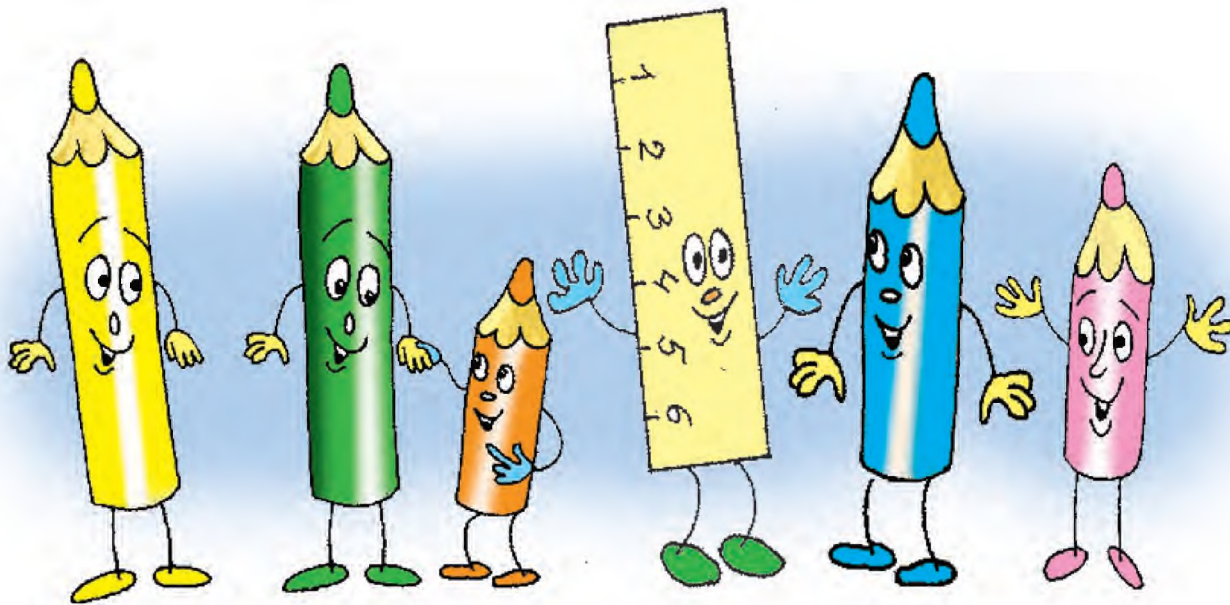

6 Play "Is it a pen?"



7 Play "Ask and answer".



Unit 2 I'm in class 1.

Lesson 3 What's this?

1



Listen and sing.

2



Watch and play
"Bingo".



3

Listen and repeat.

4



Look, listen and repeat.

This is a pen.

No, this is a book.

5



Look and play
"This is a pen".

6



Play "What's this?"



Unit 2 I'm in class 1.

Lesson 4 Let's play!

1  Listen and sing.

2  Watch and do.



3a  Look, listen and repeat.

3b  Look, listen and play.

4  Play "What's this?"

5  Play "Cross the river".



Ota-onalar uchun

Farzandingizga ilgari o'rganilgan uchta darsni qayta ko'rib chiqishini va 1-takrorlash darsiga tayyorgarlik ko'rishi kerakligini ayting.

Eslatma: 1-takrorlash darsi o'qituvchilar uchun metodik qo'llanmada berildi.

Unit 2 I'm in class 1.

Lesson 1 It's a pen.

Ota-onalar uchun

1-uy vazifasi: Farzandingizdan raqamlarni tartib bo'yicha chiziq bilan ulashlarini so'rang. (Birinchi ikkita raqam namuna uchun ko'rsatilgan.) Ular bu raqamlarni eslab aytishlari kerak: 1 – one, 2 – two, 3 – three, 4 – four, 5 – five.

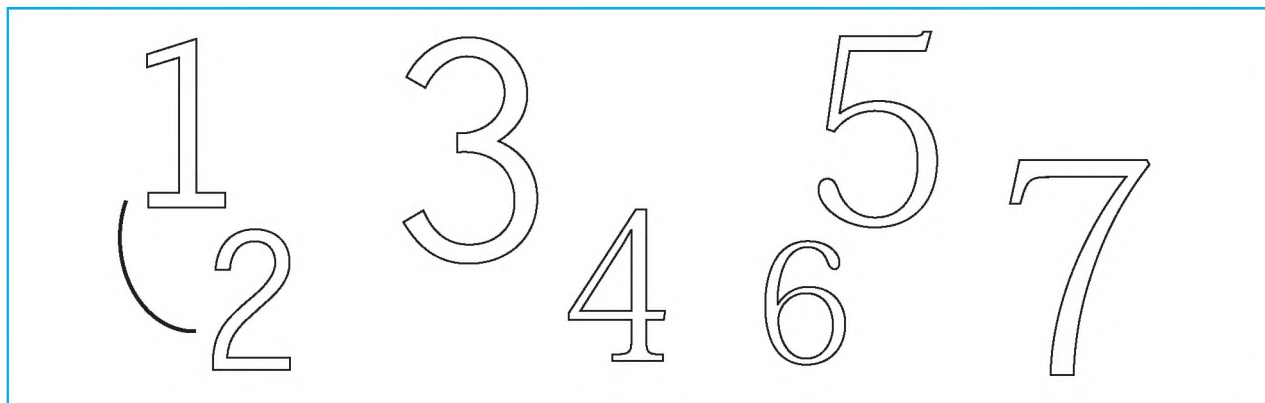

2-uy vazifasi: Berilgan rasmlardan o'quv quollarini topishini va ularni bo'yashini so'rang: a bag (sumka), a book (kitob), a copybook (daftar), a pen (ruchka), a pencil (qalam). Bo'yash paytida bu o'quv quollarining nomini ingliz tilida aytishini so'rang.

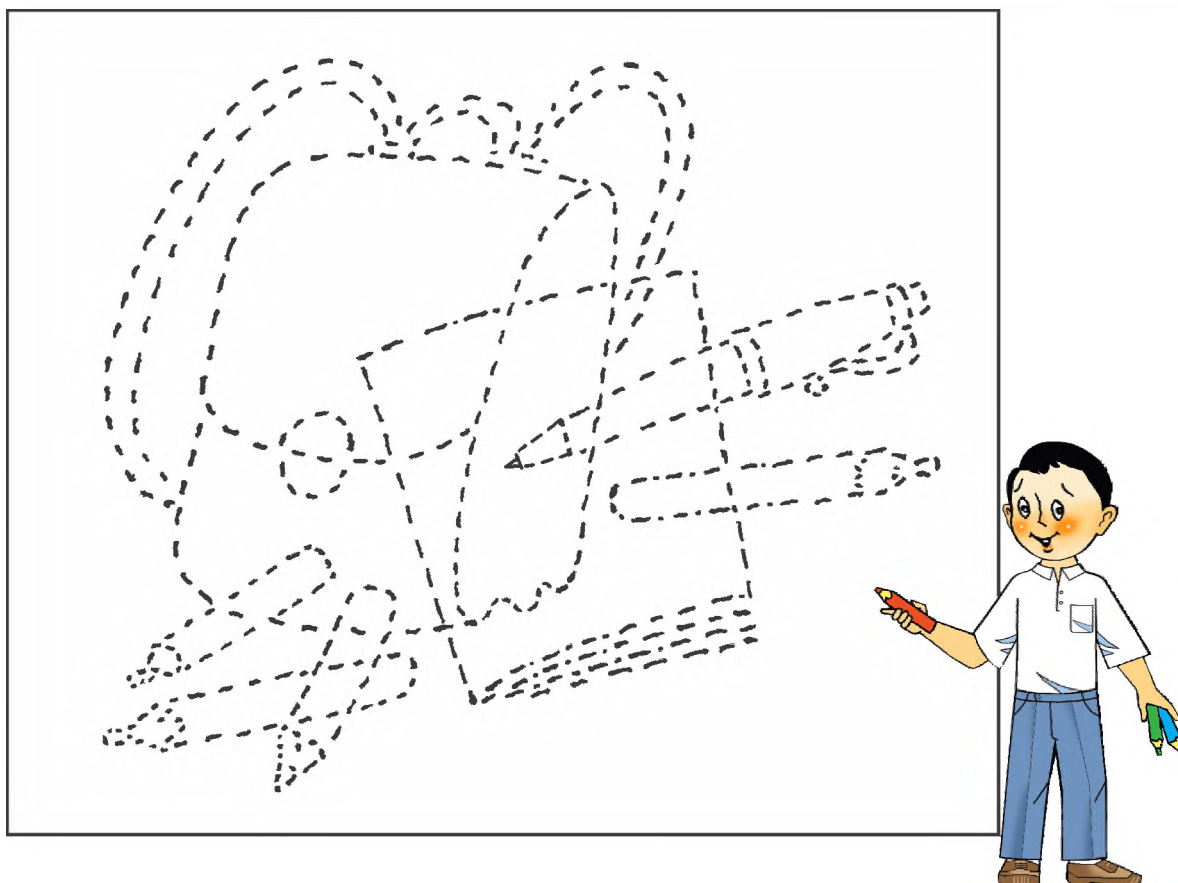

Unit 2 I'm in class 1.

Lesson 2 How old are you?



Ota-onalar uchun

1-uy vazifasi: Rasmdagi tort va shamlarni bo'yashni, so'ngra ularni sanash kerakligini tushuntiring.

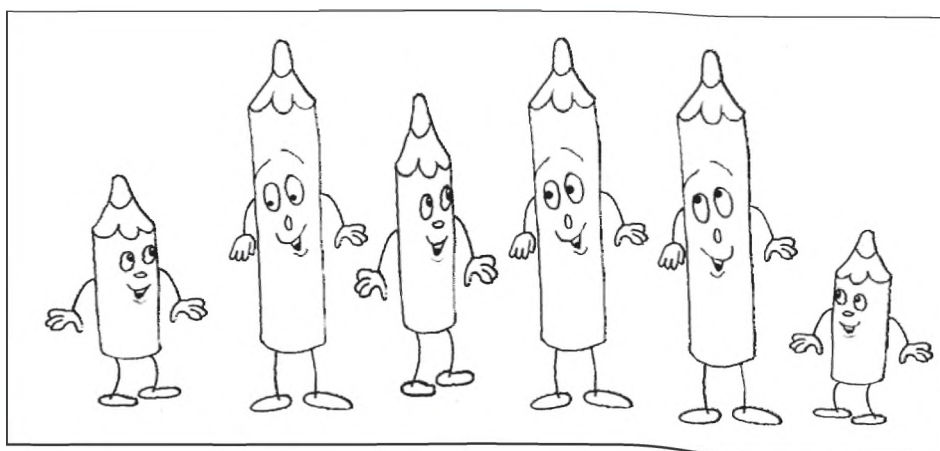

2-uy vazifasi: Bu vazifada rangli qalamlarni bo'yashi kerakligini va ular inglizchada – *a crayon* deb atalishini tushuntiring.

Eslatma: Farzandingizga keyingi darsda inglizcha tovushlar ustida ishlashi uchun kichik ko'zgu berib yuboring.

Lesson 3 What's this?

Ota-onalar uchun

Farzandingizga rasmga diqqat bilan qarashi kerakligini ayting. Rasmdan o'quv quollarini topishini va ularni ingliz tilida aytishini so'rang. Masalan: *a copybook* (daftar), *a pen* (ruchka), *a ruler* (chizg'ich), *a book* (kitob) va h.k. Bu o'quv quollarini bo'yashi kerakligini tushuntiring.

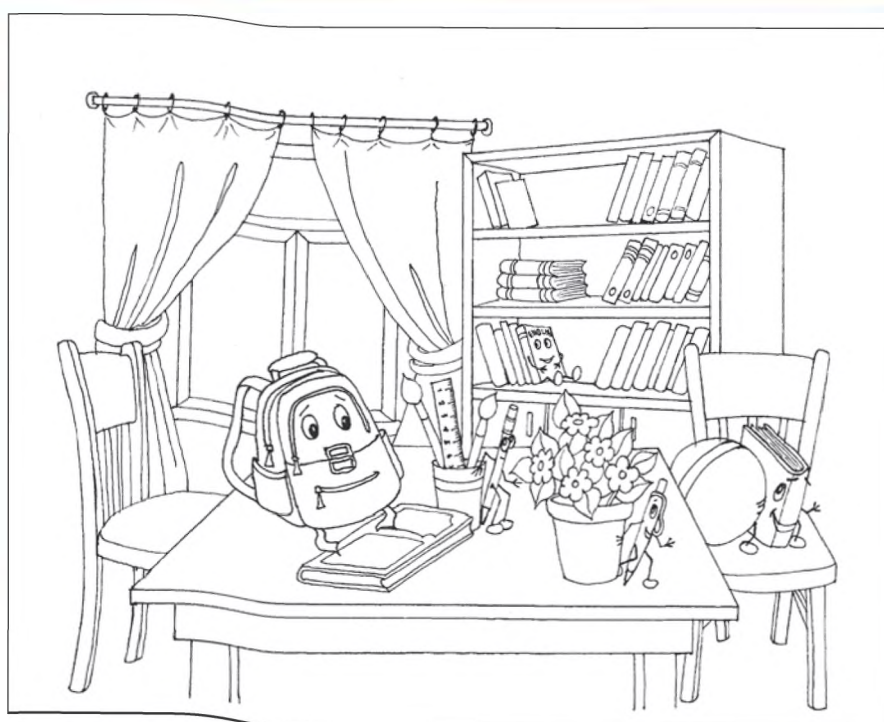

Unit 3 My family

Lesson 1 This is my mother.

1



Listen and repeat.

2

Look and listen.



3

Look and say.

4



Look and do.



5



Look, listen and repeat.

6



Look, listen and point.



7



Play "What's your name?"

Unit 3 My family

Lesson 2 I have a sister.

1  Listen and repeat.

2  Play "His name's ...".

3   Watch and do.

4a Look and say.

4b  Watch and repeat.



4c Show and say.

5  Listen and find.

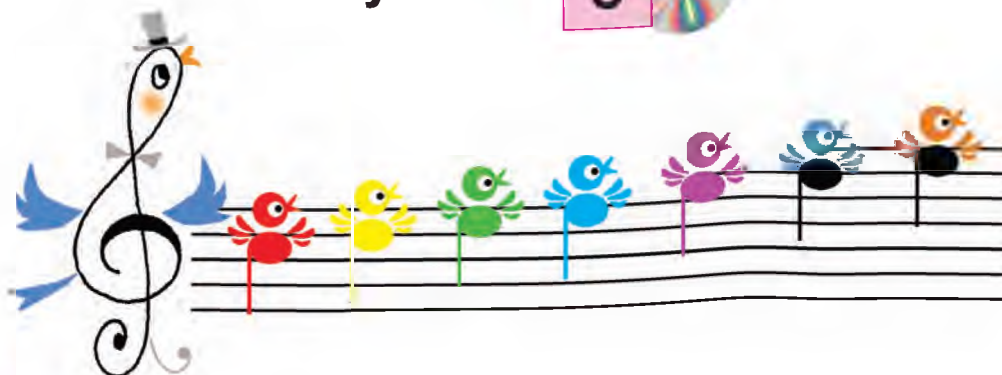

6  Play "Is it pink?"

Unit 3 My family

Lesson 3 My sister is little.

1  Listen and sing.

2   Play "What's her name?"

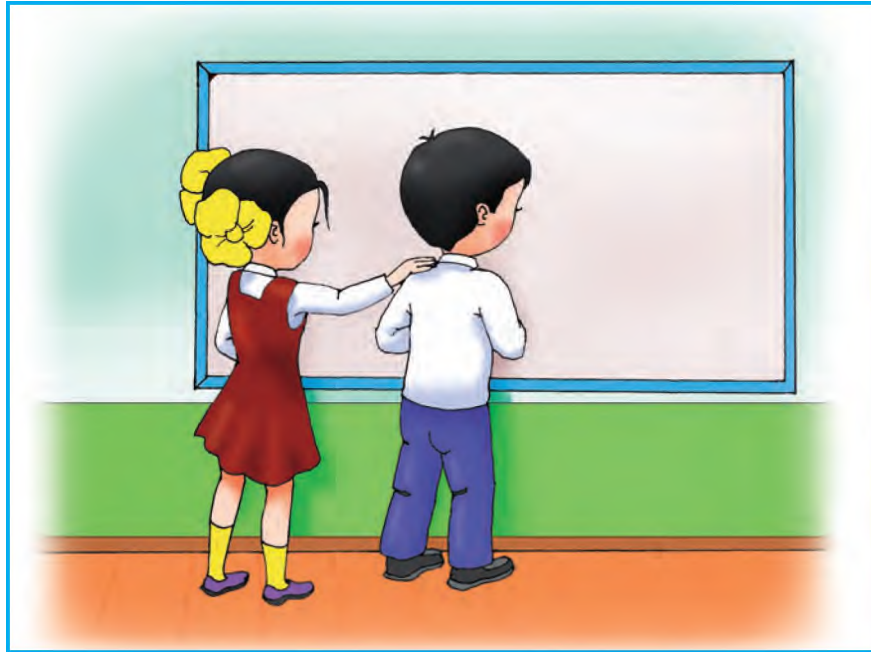

3 Show and say.

4  Look, listen and repeat.

5   Watch and do.



6  Play "Find the colour".

7   Listen and sing.

Unit 3 My family

Lesson 4 Let's play!

1



Listen and sing.

2



Play "Funny race".

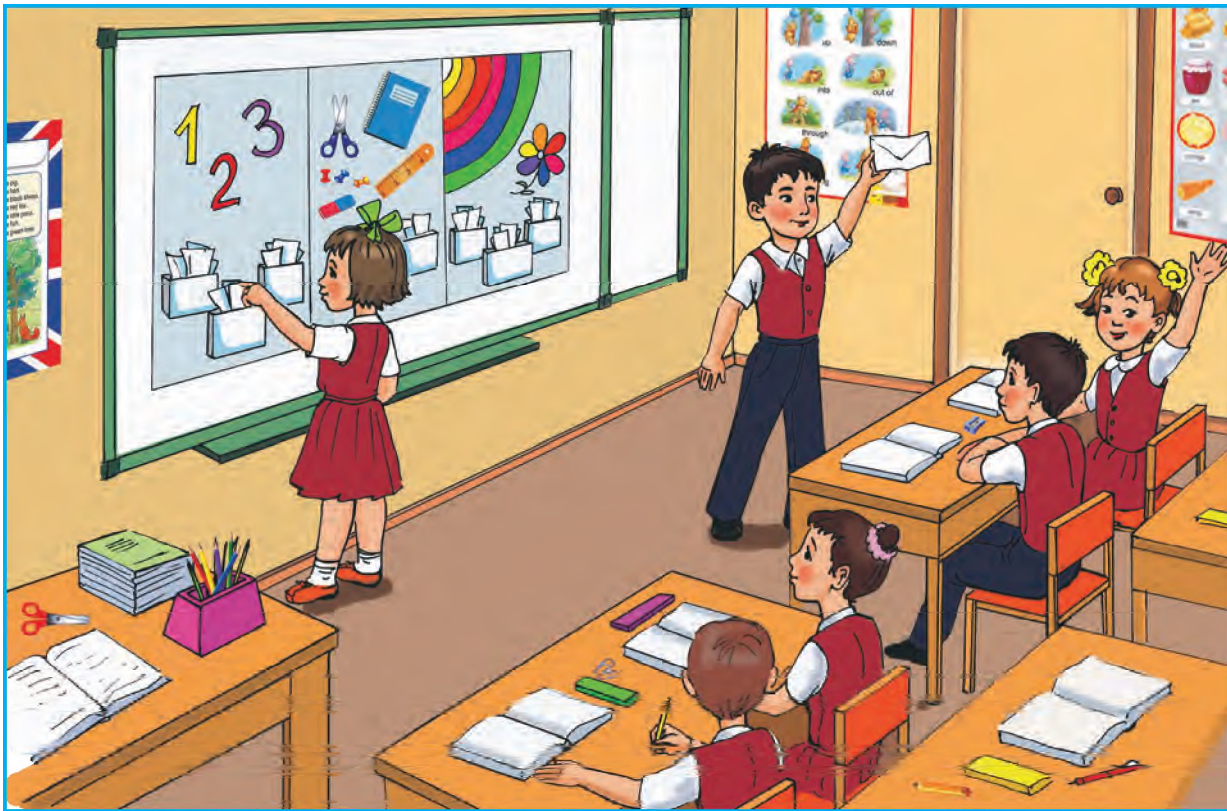

3



Play "My name's Jasur".

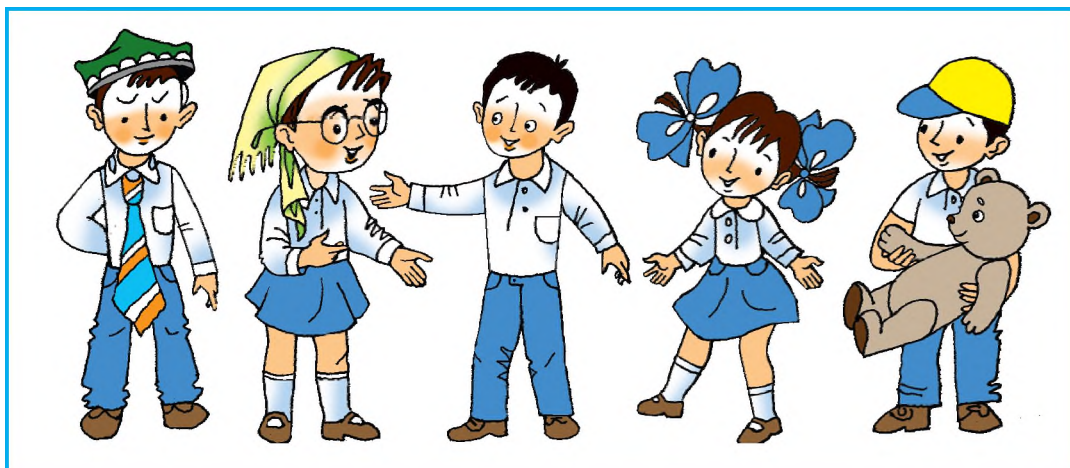

4



Sing a song.

Unit 3 My family

Lesson 1 This is my mother.

Ota-onalar uchun



Farzandingizga berilgan rasmlarni aslida qanday ko'rinishda bo'lsa, shunday rangda bo'yashi kerakligini ayting. Shuning uchun farzandingizdan quyosh, qurbaqa, atirgul, jo'ja va tovuqning rangi qanday bo'lishi kerakligini so'rang. Uni qurbaqa va jo'ja nomidan "This is my mother" deb aytting.

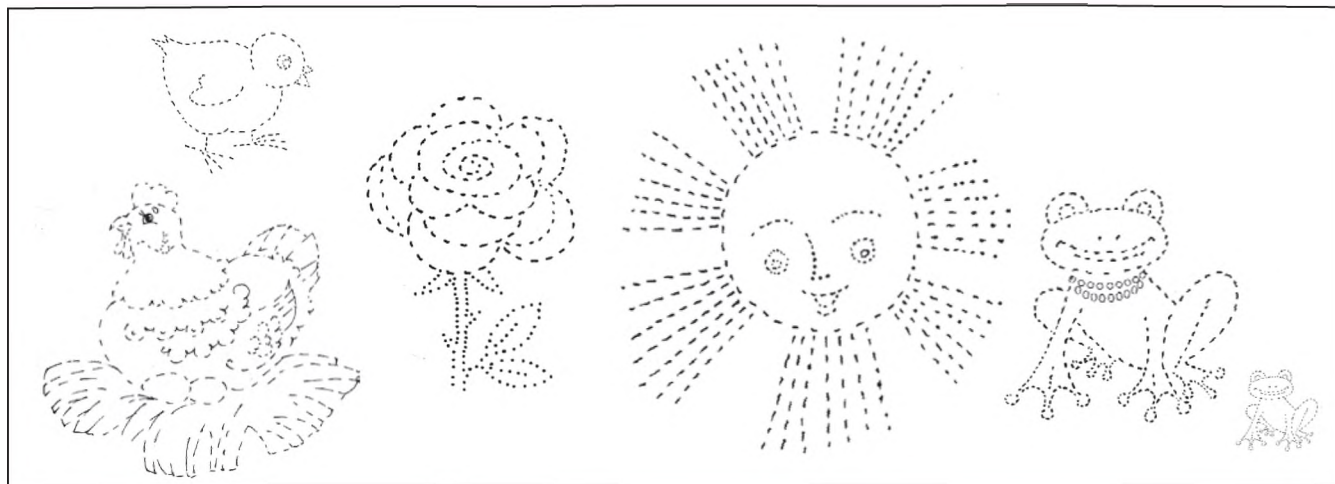

Lesson 2 I have a sister.

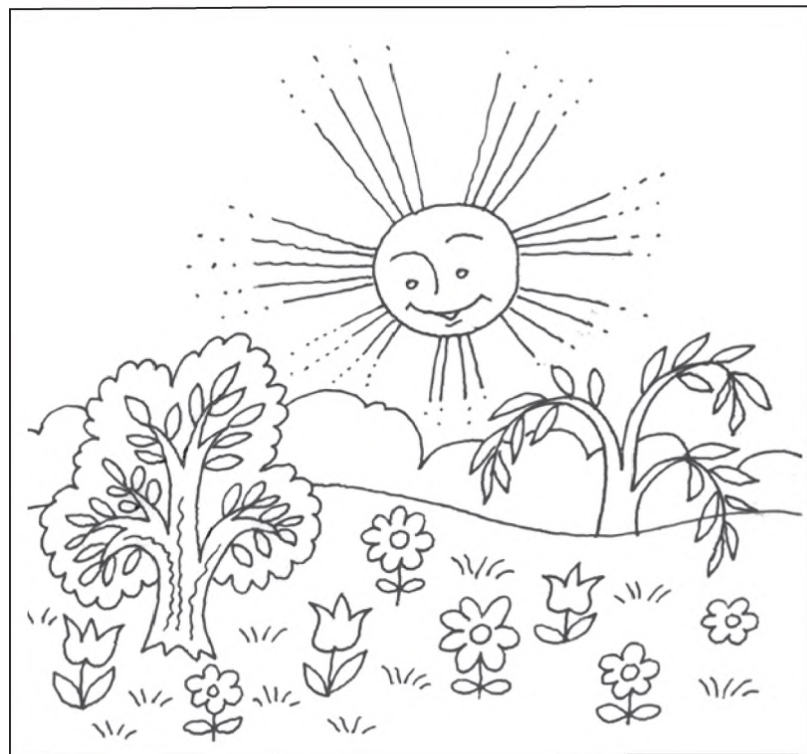

1-uy vazifasi: Farzandingizdan rasmni bo'yashini va avvalgi darsda qanday ranglarni o'rganganini eslashini so'rang (red, yellow, green, blue, pink).

2-uy vazifasi: (Qo'shimcha topshiriq) Xohishga ko'ra o'quvchilar oila a'zolari rasmini alohida oq qog'ozga chizishlari mumkin. Farzandingizdan oila haqidagi "This is my father" she'rini takrorlab berishini so'rang.

*This is my mother.
This is my father.
This is my brother tall.
This is my sister.
This is a baby.
How I love them all.*

Unit 3 My family

Lesson 3 My sister is little.

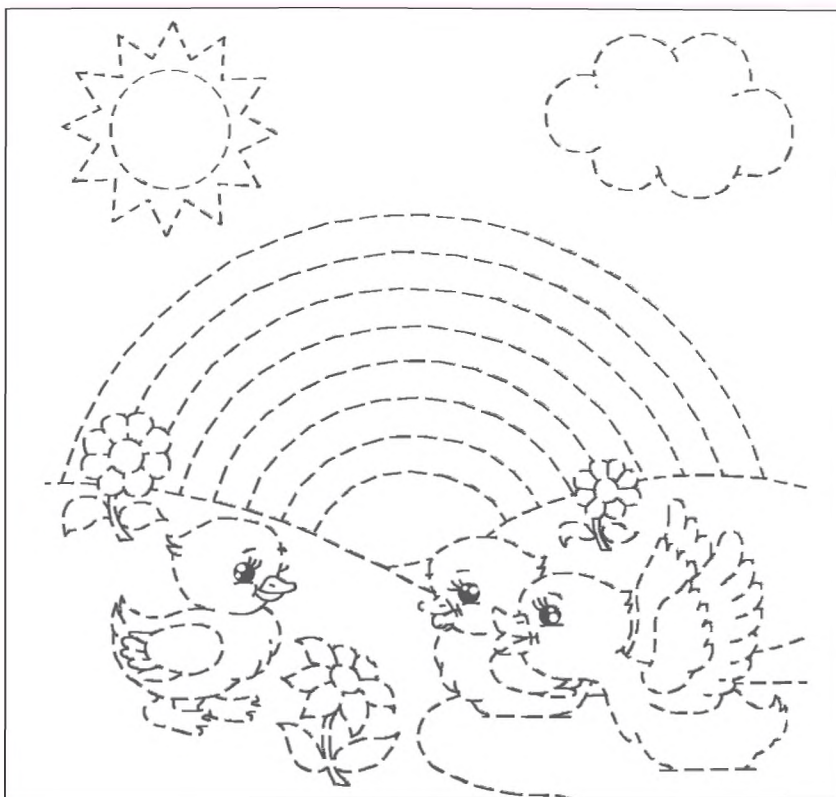

Ota-onalar uchun

Farzandingizdan rasmni bo'yashini va o'rgangan ranglarini eslashini so'rang (*red, yellow, green, blue, pink*). Kamalak qanday rangda ekanligini so'rang va uni bo'yashida yordam bering.

Lesson 4 Let's play!

Ota-onalar uchun

Farzandingizdan oldingi darslarda o'rganilgan ranglarni eslab (*red, yellow, green, blue, pink*), rasmlarni bo'yashini so'rang.

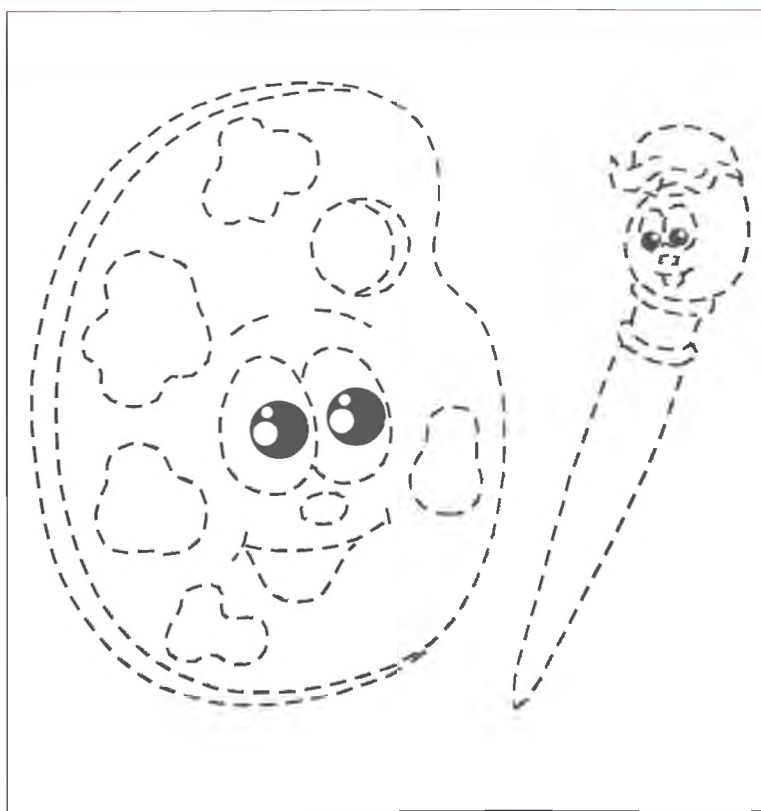

Unit 4 My friend

Lesson 1 I'm a boy.

1  Listen and repeat.

2  Play "What's your name?".

3  Look and listen.

4  Look and do.

5 Look, point and say.

6  Look and point.

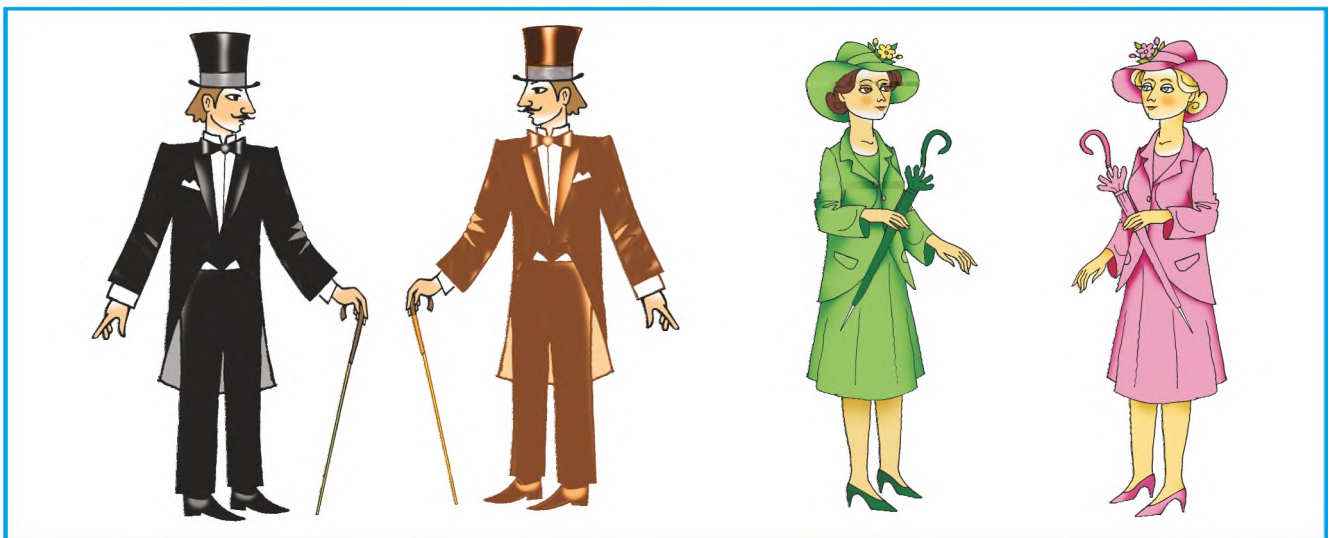

7  Look and say.

Unit 4 My friend

Lesson 2 I have a friend.

1  Listen and repeat.

2  Play "Ask and answer".



3   Look and say.

4 Look, listen and repeat.

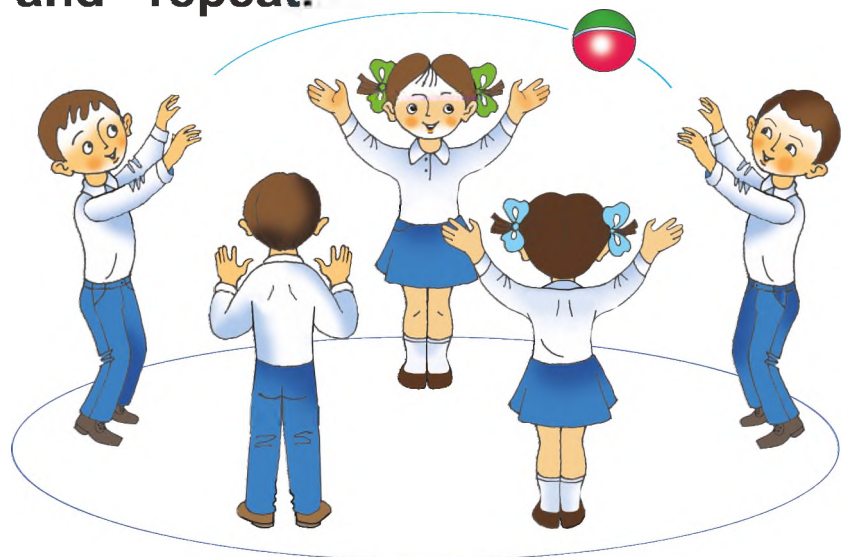

5  Play "Run and take".

Unit 4 My friend

Lesson 3 He's seven.

1



Listen and sing.

2

Look and say.

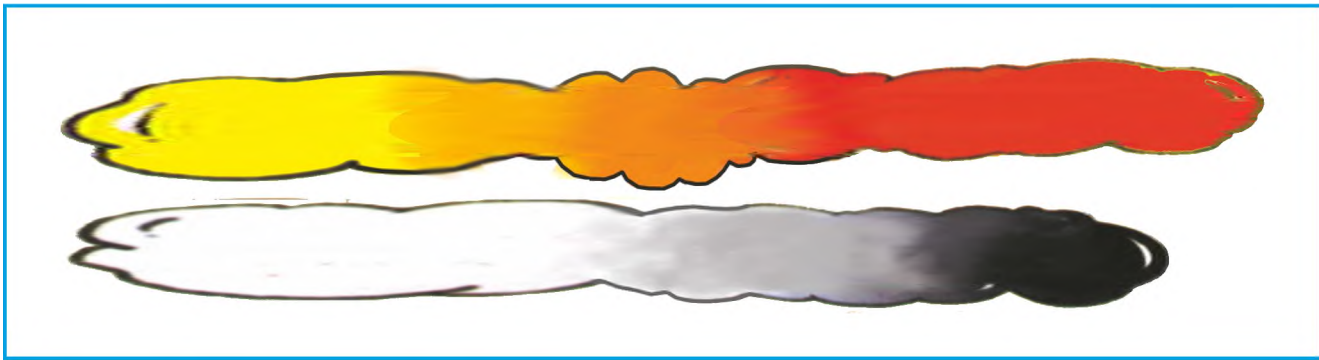

3



Look and do.

4



Play "Colours".



5a



Look and say.

5b



Play "I have a friend".

Unit 4 My friend

Lesson 4 Let's play!

1  Listen and sing.

2  Look and play "English".



3  Play "Colours".



Ota-onalar uchun

Farzandingizga ilgari o'rganilgan uchta darsni qayta ko'rib chiqishini va takrorlash darsiga tayyorgarlik ko'rishi kerakligini ayting.

Unit 4 My friend

Lesson 1 I'm a boy.



Ota-onalar uchun

Farzandingizga oldingi darslarda o'rganilgan 7 ta rangni eslashini (*red, yellow, green, blue, pink, black, brown*) va shu ranglarni ishlatib, rasmlarni bo'yashi kerakligini ayting.

Lesson 2 I have a friend.

Ota-onalar uchun

Farzandingizga oldingi darslarda o'rganilgan 9 ta rangni eslashini (*red, yellow, green, blue, pink, black, brown, white, purple*) va shu ranglarni ishlatib, rasmlarni bo'yashi kerakligini ayting.



Unit 4 My friend

Lesson 3 He's seven.

Ota-onalar uchun



Farzandingizdan rasmlardagi narsa va buyumlarni sanashlarini hamda ularning soni nechtaligini yozishlarini so'rang.

Avvalgi darslarda o'rganilgan ranglarni eslashini (*red, yellow, green, blue, pink, black, brown, white, purple, orange, grey*) va shu ranglarni ishlatib, rasmlarni bo'yashi kerakligini ayting.

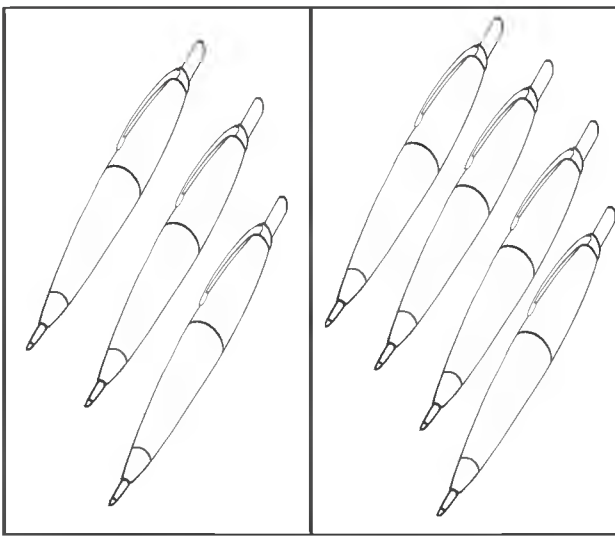

$$3+4=7$$

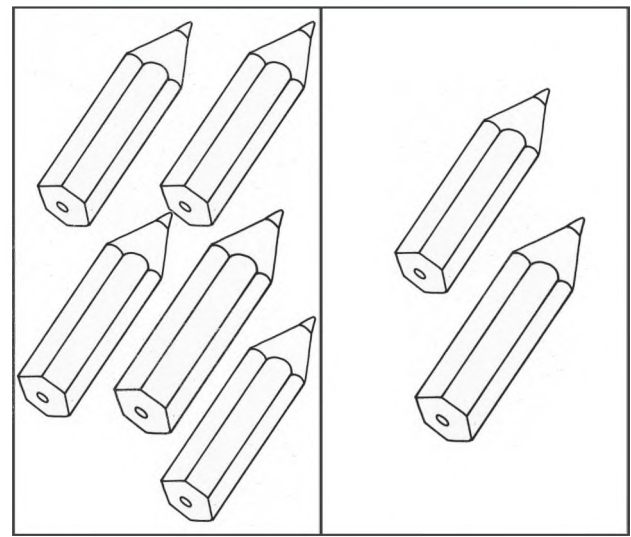

$$5+2=$$

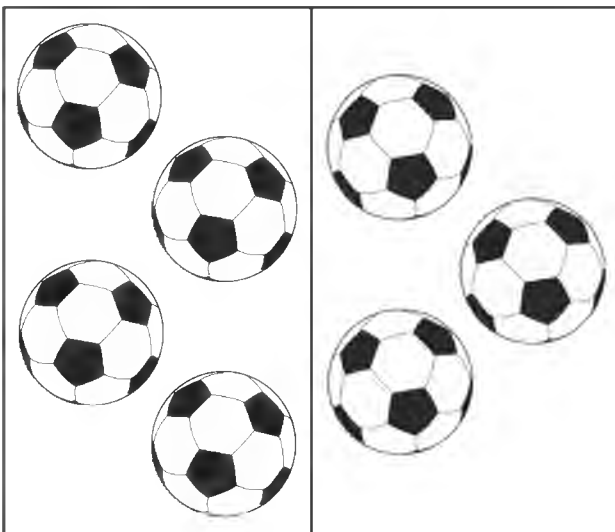

$$4+3=$$

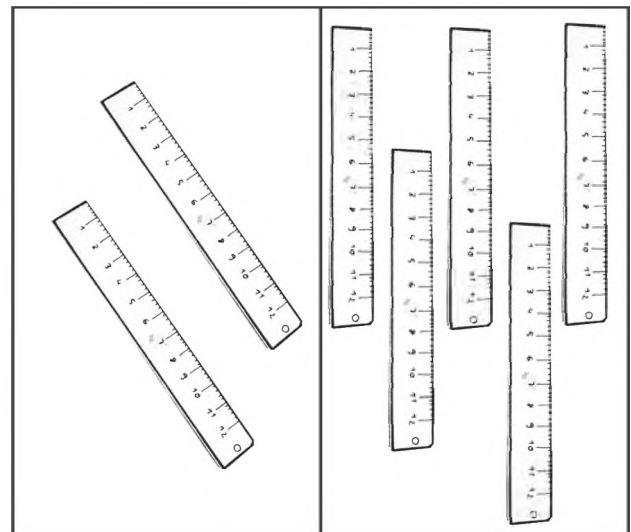

$$2+5=$$

Revision 2

1 Play "Hot seat".

2  Play "Listen and say".

3 Look, listen and tick.



4 Sing a song.

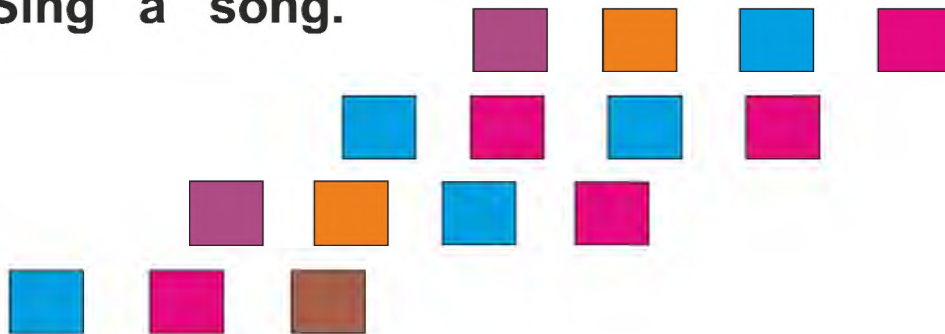

5   Play "Look, find and show".

Unit 5 Toys and colours

Lesson 1 I have a ball.

1  Listen and say.

2  Play "Red, yellow and green".

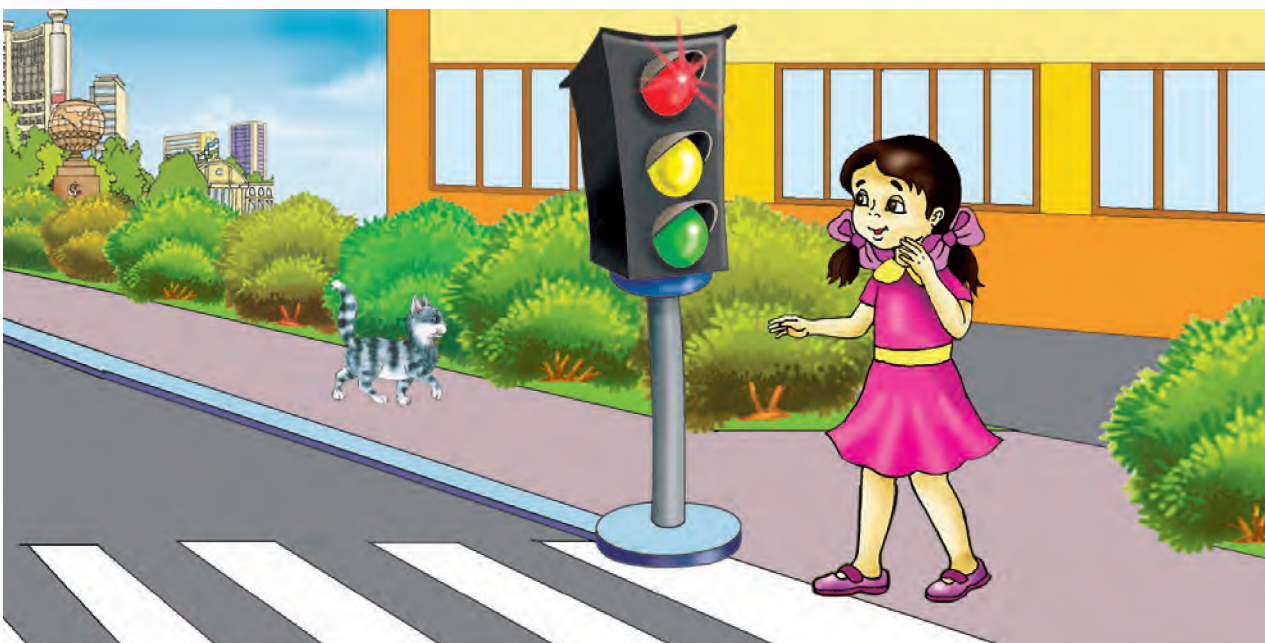

3   Play "What's this?"

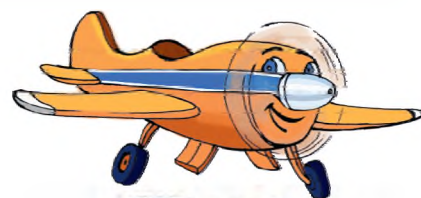

4  Look, listen and do.



5  Play "1, 2. Go!"

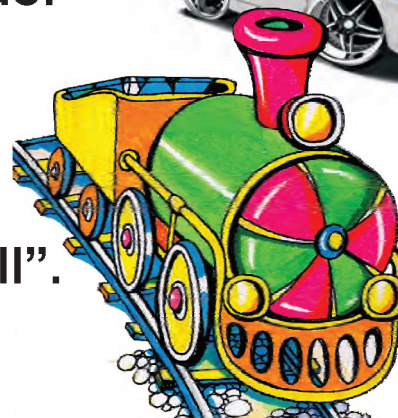

6   Play "I have a ball".



7   Ask and answer.

Unit 5 Toys and colours

Lesson 2 It's purple.

1



Listen and sing.



2



Play "I have a balloon".



3



Watch and do.

4



Play "This is a plane".

5



Look and colour.

Unit 5 Toys and colours

Lesson 3 I like it.

1



Listen and sing.

2

Look, listen and say.

3



Play "Run and say colours".

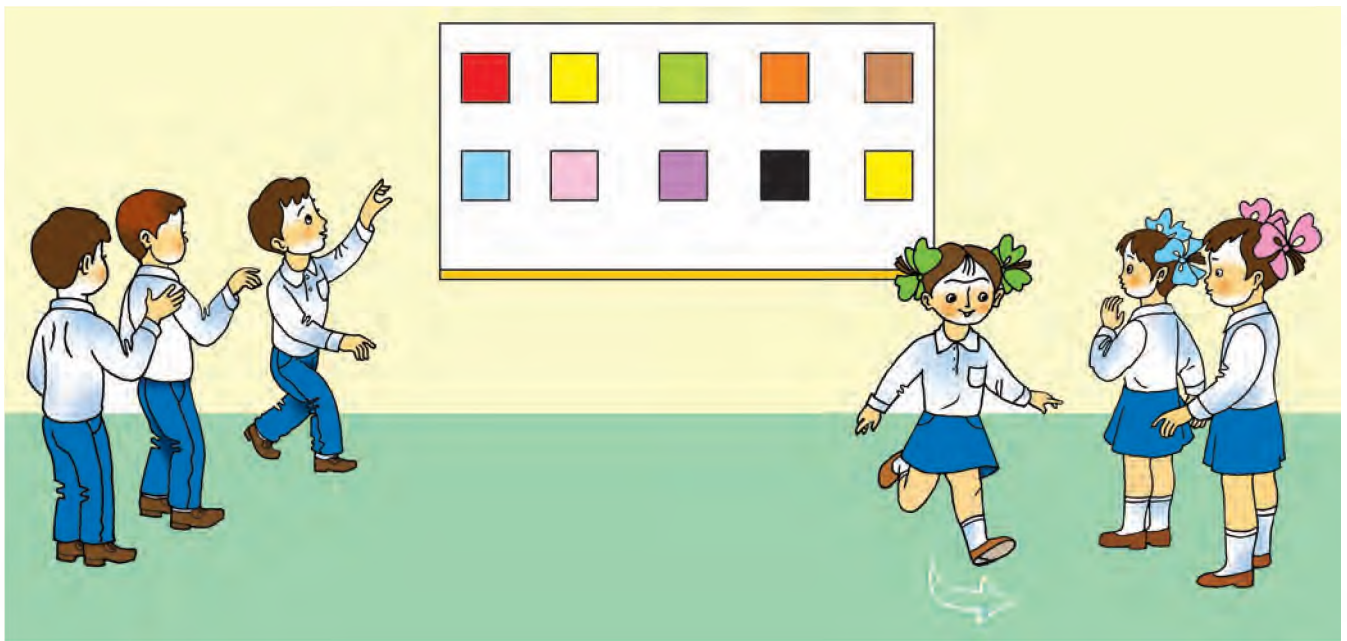

4



Listen and repeat.

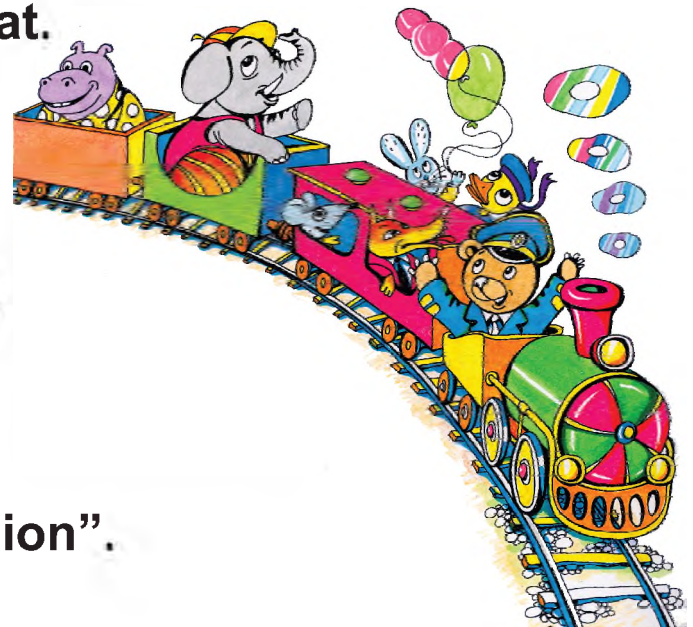

5



Play "I like it".

6



Play "Champion".

Unit 5 Toys and colours

Lesson 4 Let's play!

1



Listen and sing.

2



Play "Champion".

3



Look and do.

4



Play "I like it!".



5



Play "1, 2, 3 ...?"

Unit 5 Toys and colours

Lesson 1 I have a ball.

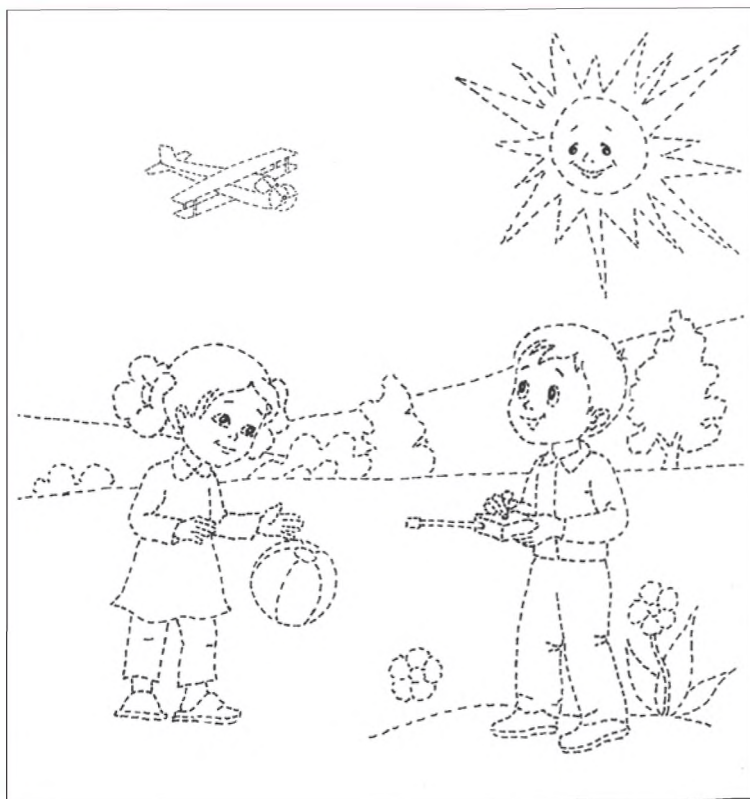

Ota-onalar uchun

Farzandingizga rasmni bo'yash kerakligini ayting. Samolyot va koptok (to'p) inglizchada qanday aytilishini so'rang (*a plane, a ball*).

Lesson 2 It's purple.

Ota-onalar uchun

Farzandingizga o'yinchoqlarni bo'yash kerakligini ayting. Rasmlardagi o'yinchoqlarning ingliz tilida qanday aytilishini so'rang. *A kite (varrak), a ball (koptok), a balloon (pufak), a doll (qo'g'irchoq), a plane (samolyot), a car (mashina), a train (poyezd), a Teddy bear (o'yinchoq ayiqcha)*.



Unit 5 Toys and colours

Lesson 3 I like it.



Ota-onalar uchun

1-uy vazifasi: Farzandingizga pufaklarni ushlagan qizning rasmini va pufaklarni bo'yashi kerakligini ayting. Ranglarning ingliz tilida qanday aytilishini so'rang.

2-uy vazifasi: Farzandingizga keyingi dars uchun sevimli (kichik hajmdagi) o'yinchoqlaridan birini berib yuboring.

Lesson 4 Let's play!

Ota-onalar uchun

Farzandingizdan bolalarning o'yinchoqlarini chiziq tortish orqali topishini so'rang. Birinchi ikki chiziq namuna uchun berilgan. O'g'il bolada varrak, qiz bolada esa koptok (to'p). Ba'zi o'yinchoqlarni qiz bola ham, o'g'il bola ham o'ynashi mumkinligini ayting. Masalan, koptokni qiz bola ham, o'g'il bola ham o'ynashi mumkin.

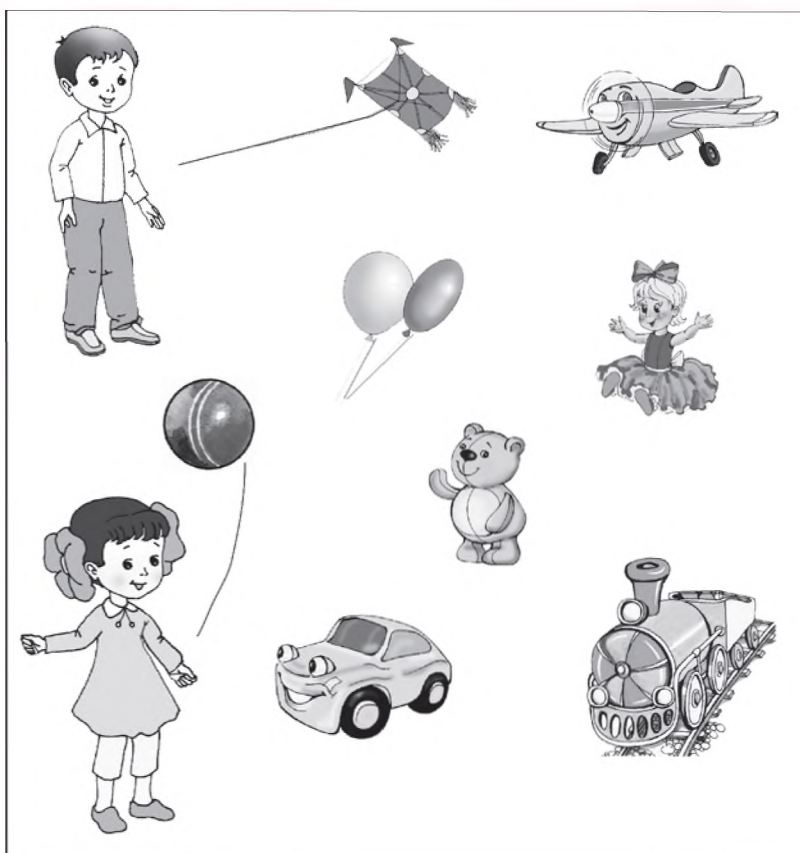

Unit 6 Parts of the body

Lesson 1 Touch your nose.

1 Listen and repeat.

2 Look, listen and say.



2



3

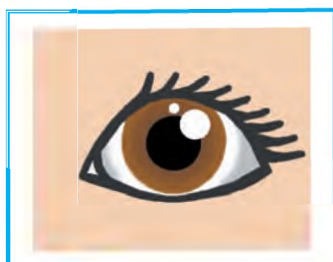

4

1

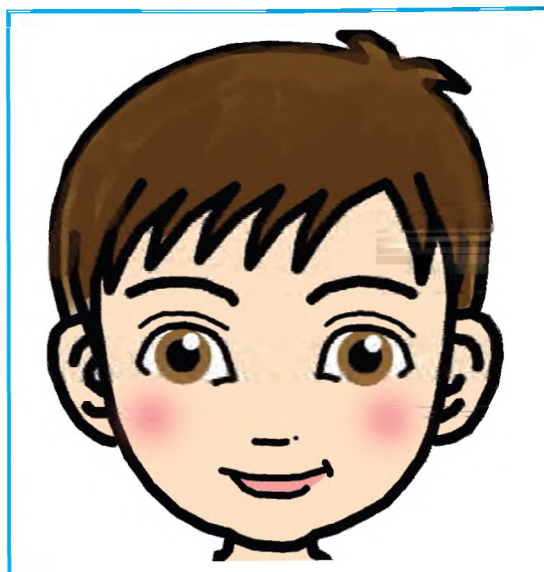

5

3



Play "Touch your nose".

6



4



Look and do.

Unit 6 Parts of the body

Lesson 2 Left hand, right hand.

1



Listen and sing.

2

Look, listen and do.

3



Play "Draw a robot".

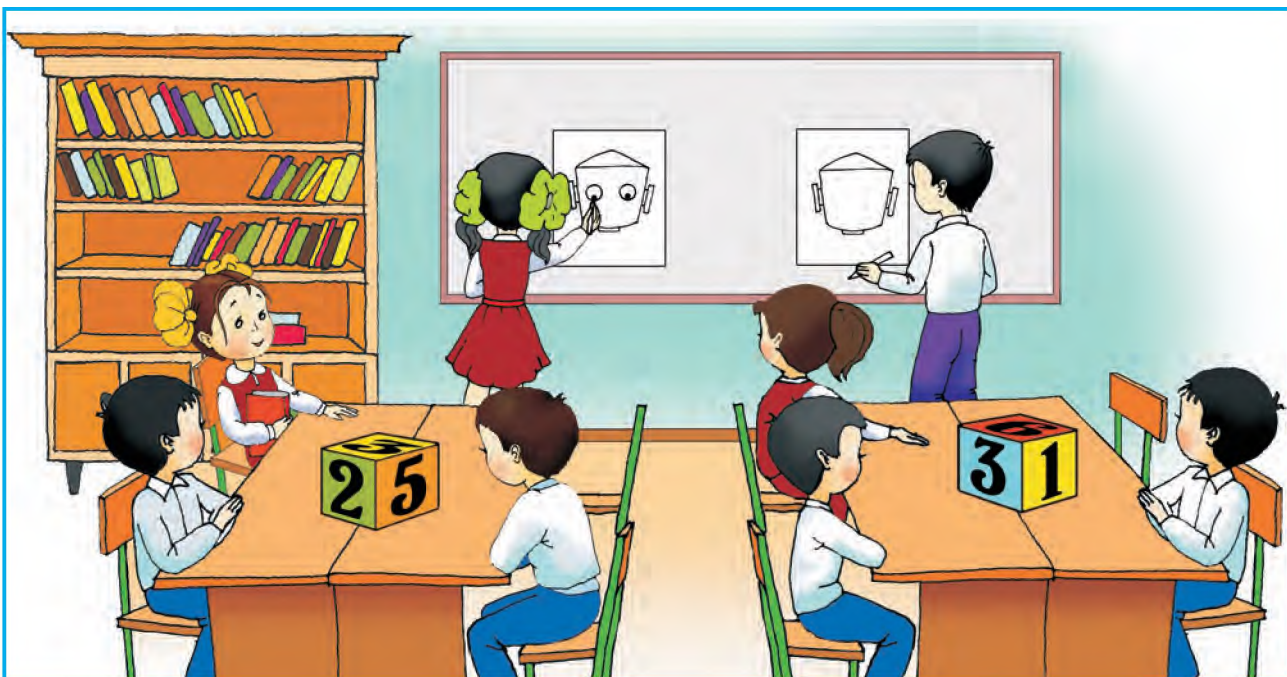

4



Look and do.

5



Look, listen and do.

6



Ask and answer.



Unit 6 Parts of the body

Lesson 3 Robot, jump!

1



Listen and sing.

2



Play "I am a robot".

3



Look, listen and say.

4



Play "Go, jump ...".

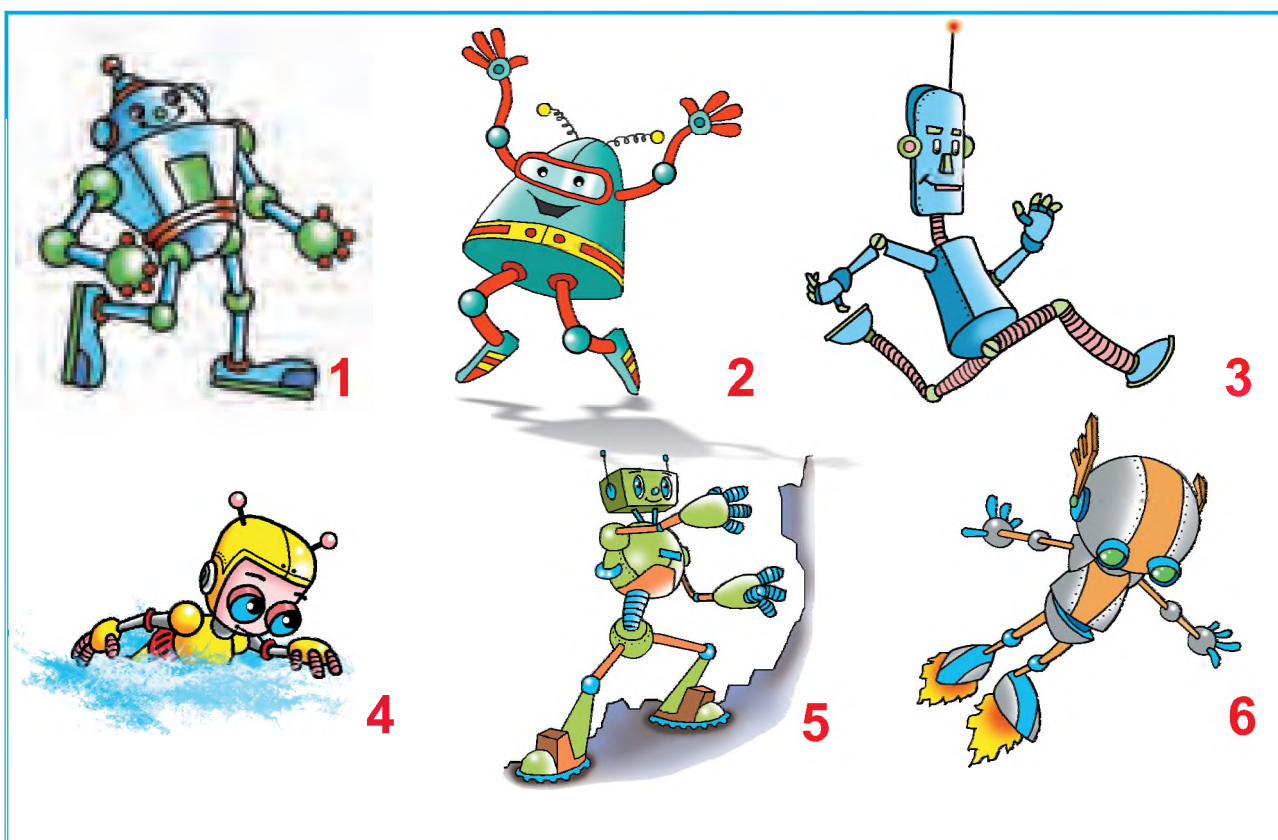
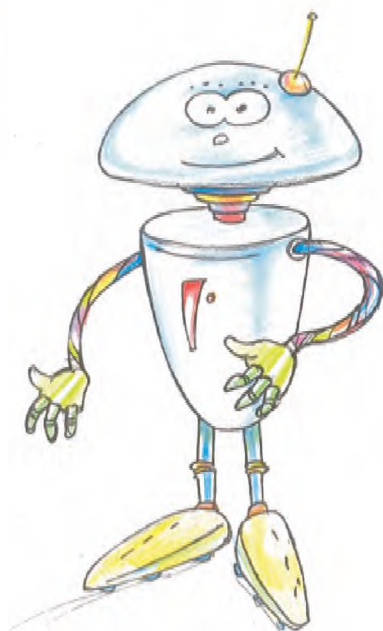

5



Play "Head, nose ...".

Unit 6 Parts of the body

Lesson 4 Let's play!

1



Listen and sing.

2



Play "Please".

3



Play "Crayon. Robot, run!"



4



Look, listen and do.

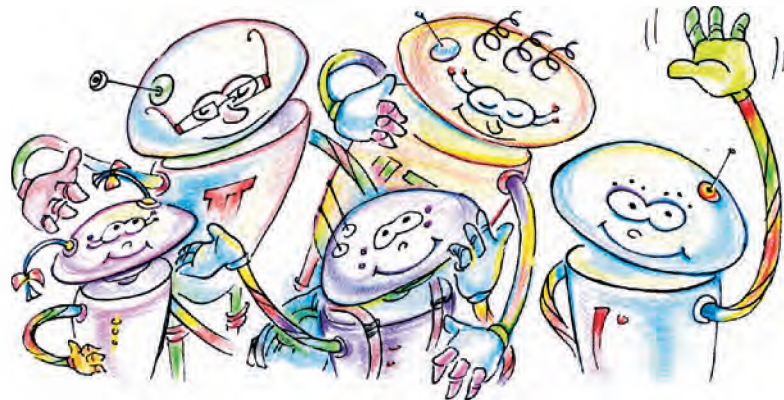

5



Look and say.

Ota-onalar uchun

Farzandingizga ilgari o'rganilgan uchta darsni qayta ko'rib chiqishini va takrorlash darsiga tayyorgarlik ko'rishi kerakligini ayting.

Unit 6 Parts of the body

Lesson 1 Touch your nose.



Ota-onalar uchun

Farzandingizga robotning bosh qismida tushirib qoldirilgan a'zolarini chizishi kerakligini ayting. Robotni bo'yash paytida bosh a'zolarini ingliz tilida aytishini so'rang: *head (bosh), eye (ko'z), nose (burun), ear (quloq), mouth (og'iz), hair (soch).*

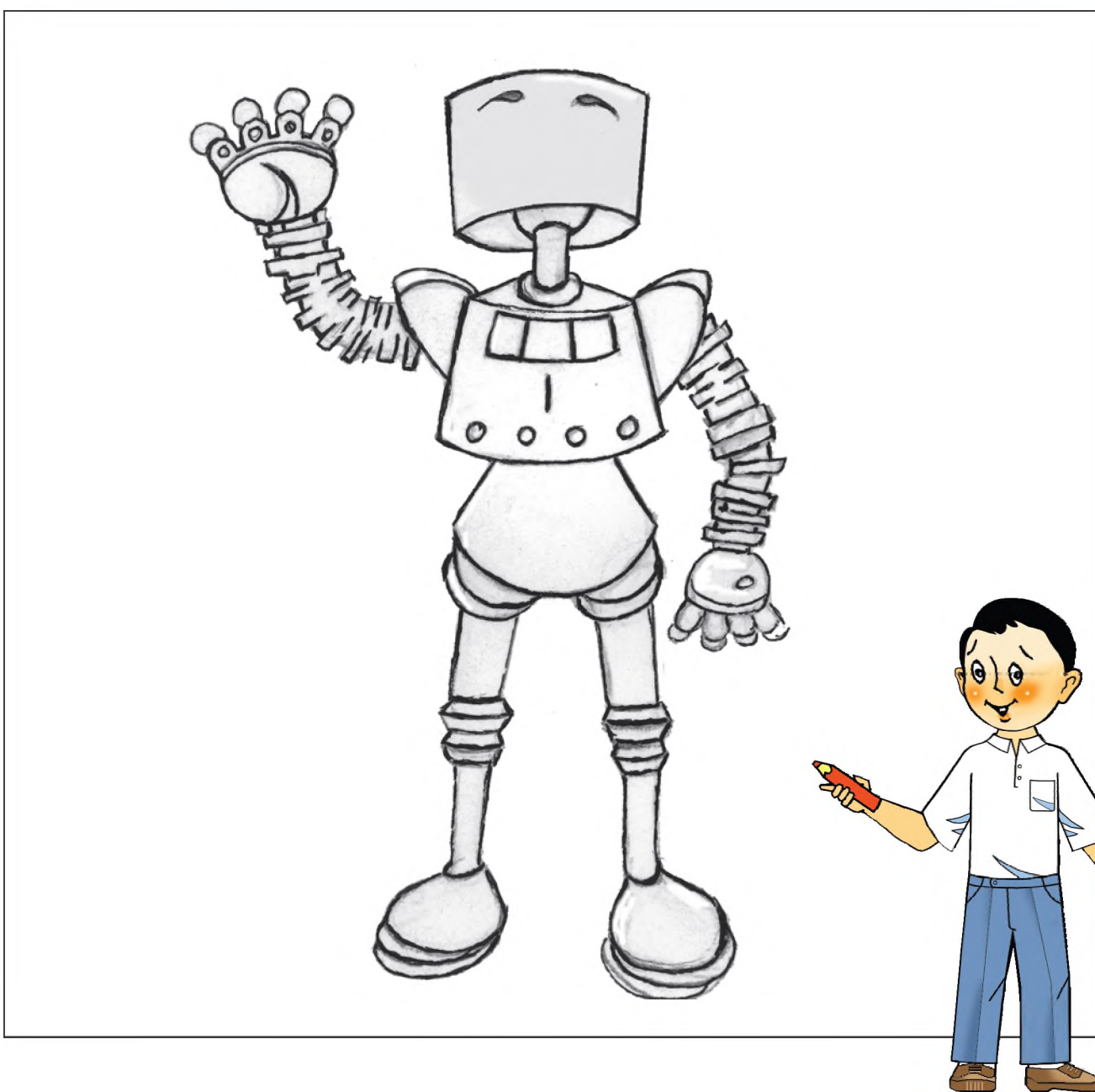

Unit 6 Parts of the body

Lesson 2 Left hand, right hand.

Ota-onalar uchun

Farzandingizga robotlarning bosh qismida tushirib qoldirilgan a'zolarini chizishini so'rang (ularni robotlarning o'zlari ko'rsatib turibdi). Robotlarni bo'yash paytida bosh a'zolarini ingliz tilida aytishlari kerakligini ayting: *eye (ko'z)*, *nose (burun)*, *ear (quloq)*, *hair (soch)*.

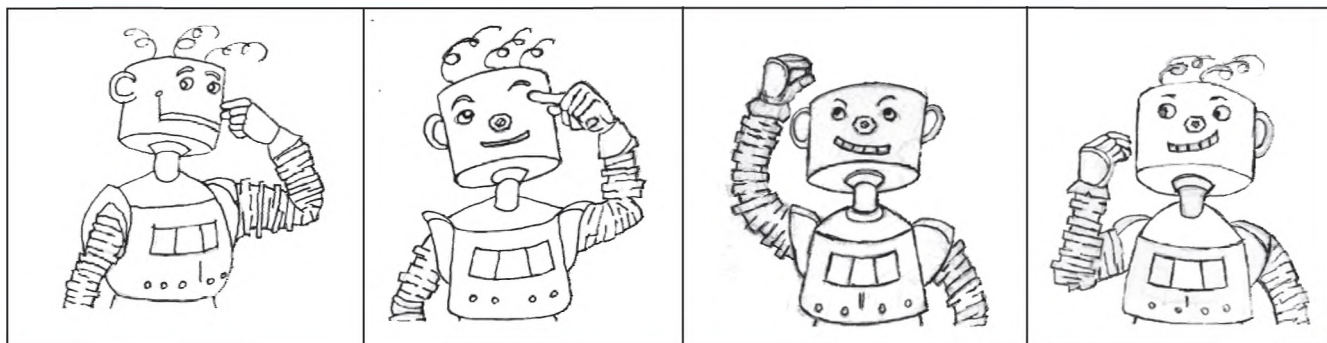

Lesson 3 Robot, jump!

Farzandingizga robotlarni bo'yashi kerakligini ayting va darsda o'rganilgan buyruqlarni eslashini so'rang: *Robot, fly! (Robot, uch!)* *Robot, go! (Robot, bor!)*, *Robot, jump! (Robot, sakra!)*

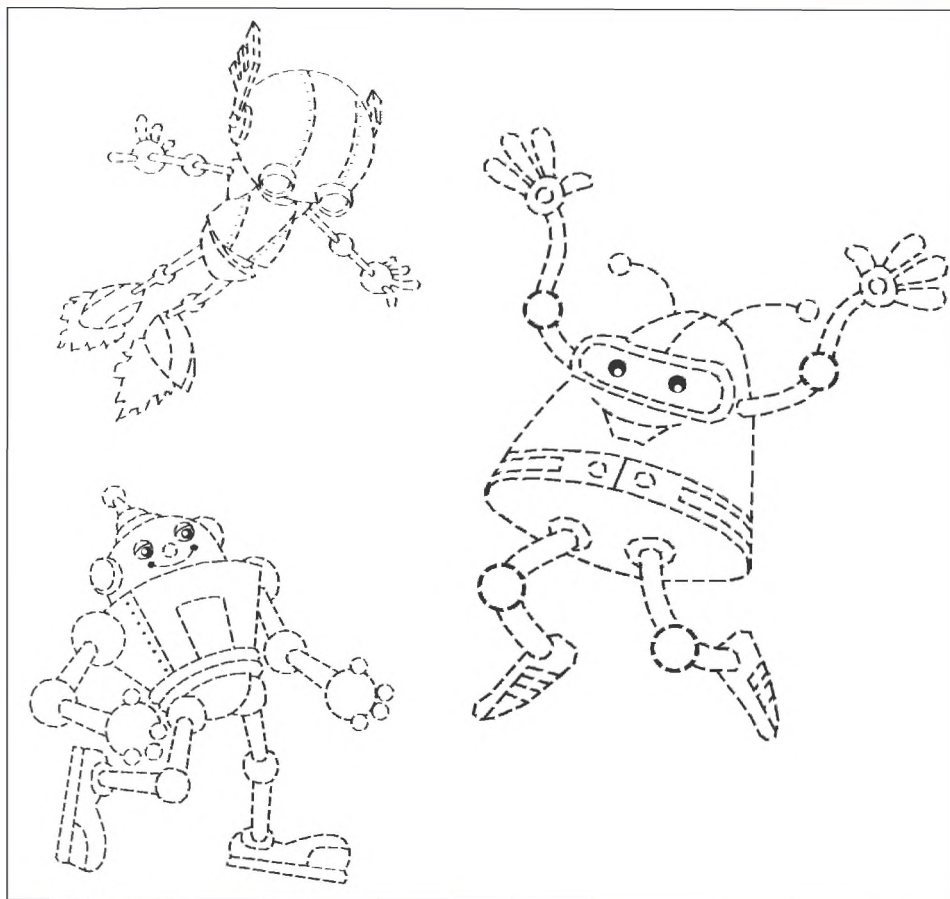

Revision 3

1 Look, listen and tick.

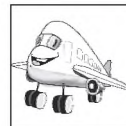

2 Look and draw a line.

9

2

3

5

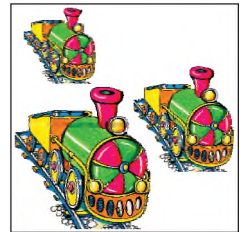
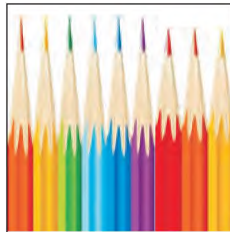

3 Look, listen and tick.

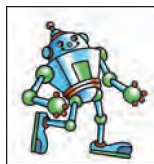
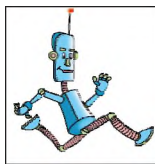
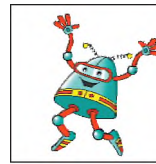
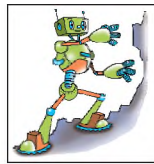
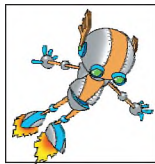

4 Look and say.

Unit 7 Seasons

Lesson 1 Winter is white.

1



Listen and say.

2



Look, listen and say.

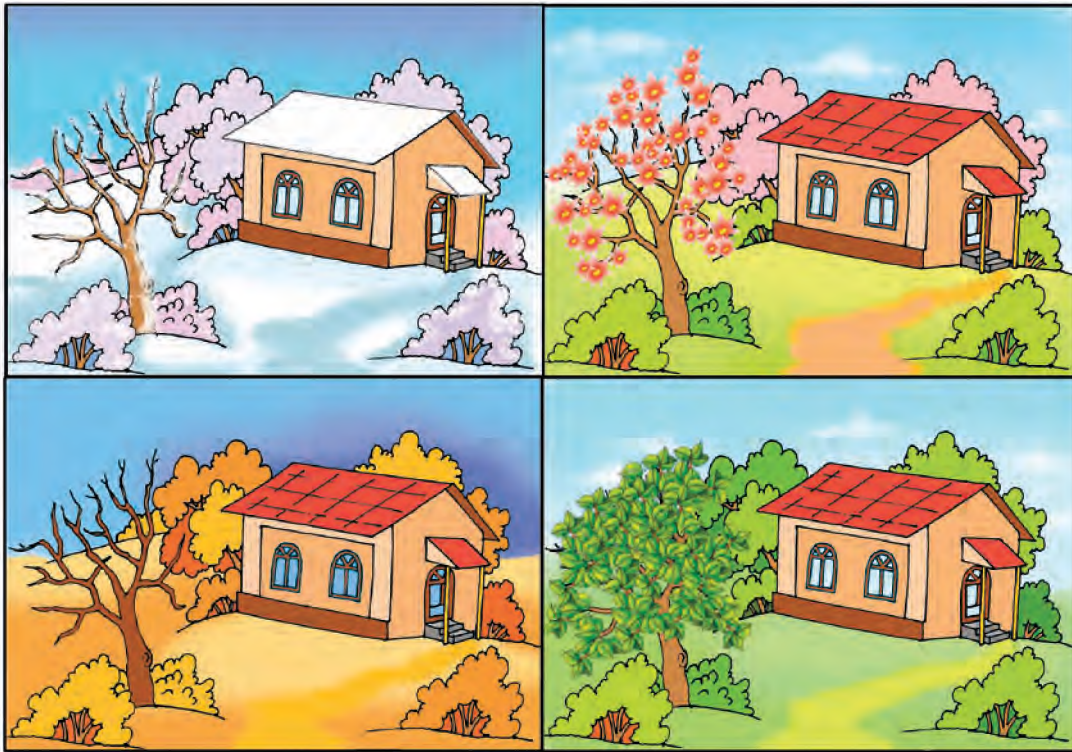

3



Play "Sleep!"

4



Play "It's winter".



5



Play "What season is it?"

Unit 7 Seasons

Lesson 2 What colour is winter?

1  Listen and sing.

2   Play "What colour is spring?"



3  Look and do. 4  Look, listen and say.



5  Play "Ask and answer."

Unit 7 Seasons

Lesson 3 It's warm.

1 Listen and repeat.

2 Look and say.

3  Look and do.

4 Play "What season is it?"

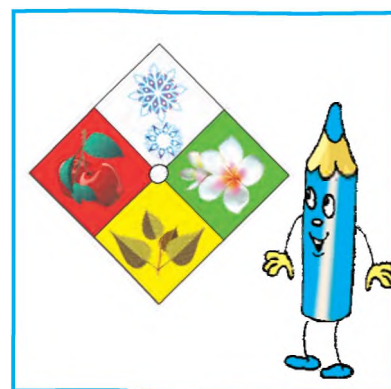
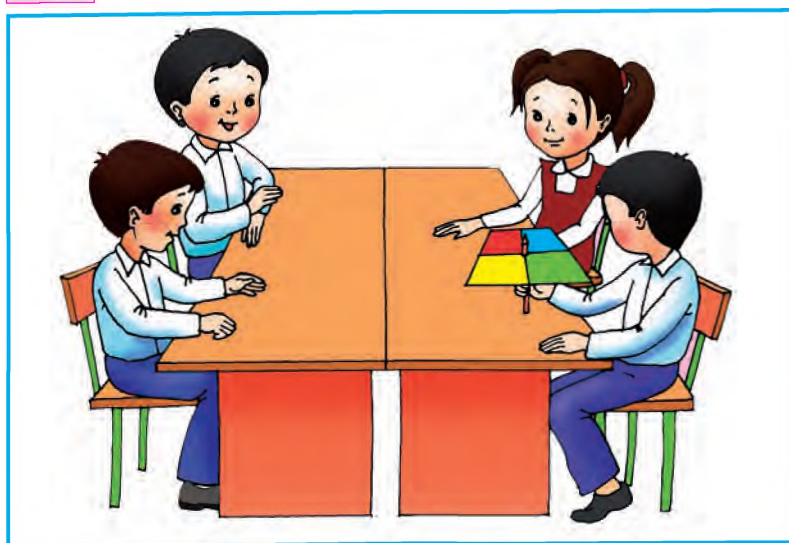

5  Play "Cold. Warm. Hot!"



Unit 7 Seasons

Lesson 4 Let's play!

1 Listen and say.

2   Play "Autumn + yellow".

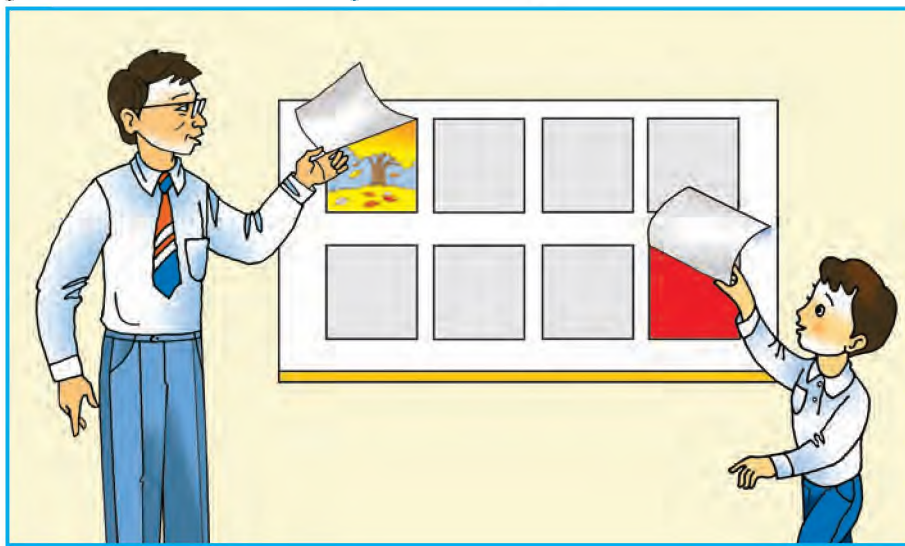

3   Play "Look and guess".



4  Play "Look, choose and say".

Ota-onalar uchun

Farzandingizga ilgari o'rganilgan uchta darsni qayta ko'rib chiqishini va takrorlash darsiga tayyorgarlik ko'rishi kerakligini ayting.

Unit 7 Seasons

Lesson 1 Winter is white.

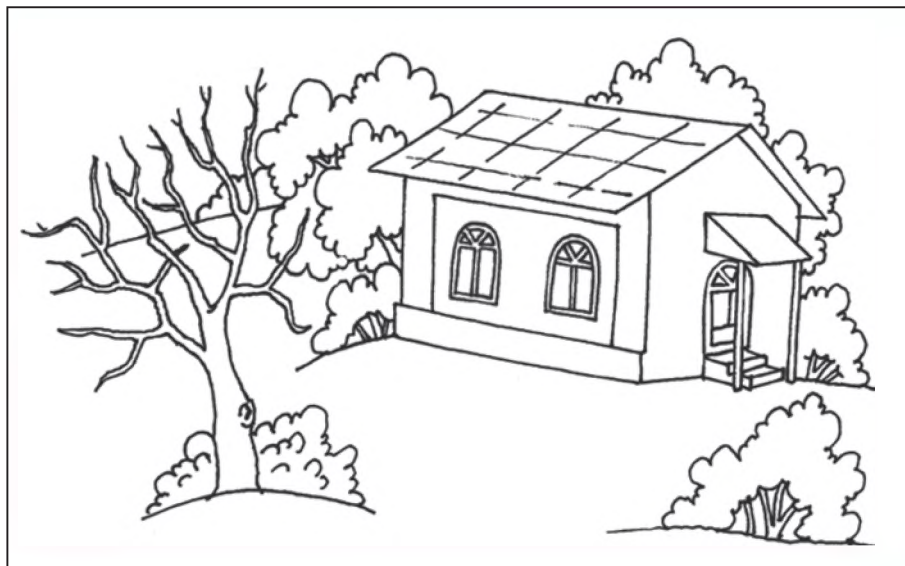

Ota-onalar uchun

Farzandingizdan avvalgi darslarga qarab, ingliz tilida yil fasllari qanday aytilishini eslashini so'rang: *winter* (*qish*), *spring* (*bahor*), *summer* (*yoz*), *autumn* (*kuz*). Farzandingiz o'zi yoqtirgan yil faslini tanlab, o'sha rasmni bo'yashi kerakligini ayting "It's..."

Lesson 2 What colour is winter?

Ota-onalar uchun

Farzandingizdan rasmga qarashini va bu qaysi fasl ekanligini so'rang: *winter* (*qish*). Rasmni bo'yashi kerakligini ayting.

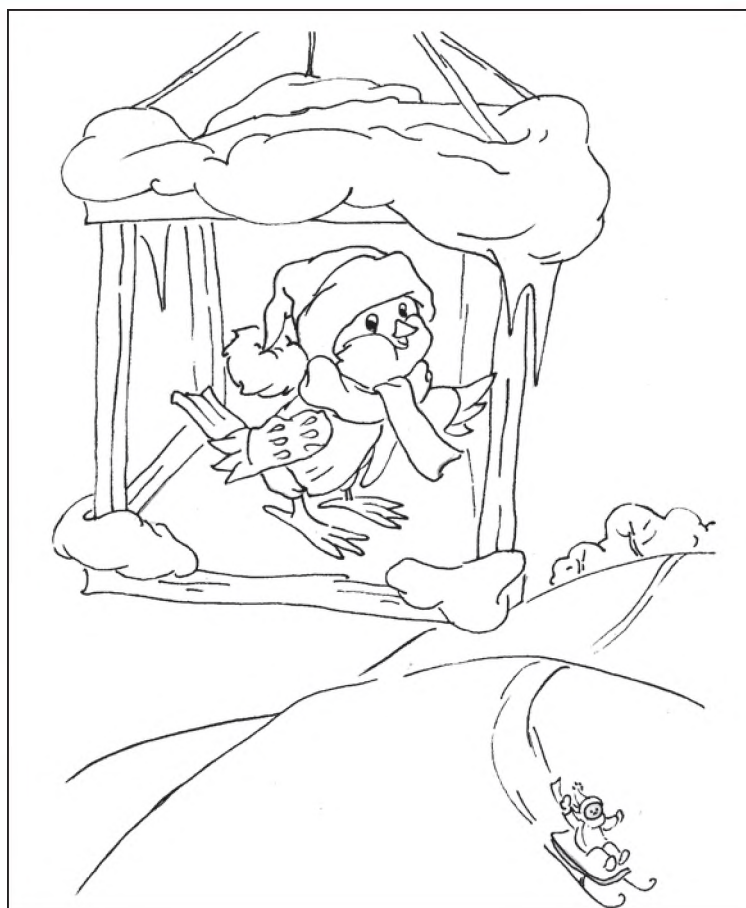

Unit 7 Seasons

Lesson 3 It's warm.

Ota-onalar uchun

Farzandingizdan avvalgi darsga qarab, quyidagi so'zlar ingliz tilida qanday aytilishini so'rang:

Sovuq. (*It is cold.*)

Iliq. (*It is warm.*)

Issiq. (*It is hot.*)

Salqin. (*It is cool.*)

Rasmni bo'yashni va "It's warm" (iliq) deb inglizcha aytishni so'rang.



Revision 4

1 Answer the questions.

2 Look and match.

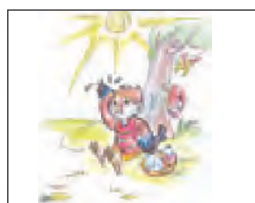

3 Look and tick.

1					
2					
3					
4					

4 Play "Miming".

Unit 8 The world around us

Lesson 1 What's the weather?

1  Listen and repeat.

2  Look, listen and say.



3  Play "It's sunny today".

4  Look and do.



5   Play "It's winter. It's snowy".

Unit 8 The world around us

Lesson 2 I can ski.

1  Listen and repeat.

2  Play "It's cold".

3   Look and do.

4  Look, listen and say.

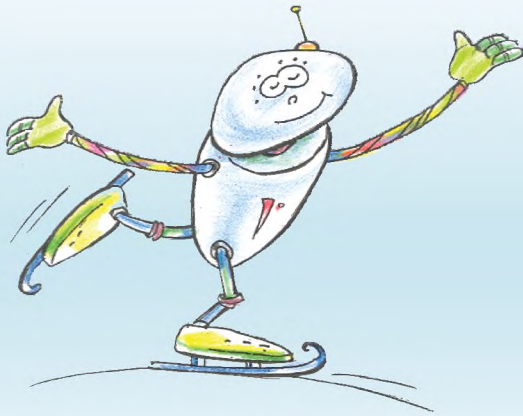

5  Play "I can skate".



Unit 8 The world around us

Lesson 3 I can fly a kite.

1  Listen and sing.

2a  Look, listen and say.



2b  Play "Fly a kite".



3  Look, listen and do.

4  Play "It's summer. I can swim".

Unit 8 The world around us

Lesson 4 Let's play

1  Look and guess.

2  Play "What season is it?".

3  Play "Doctor".

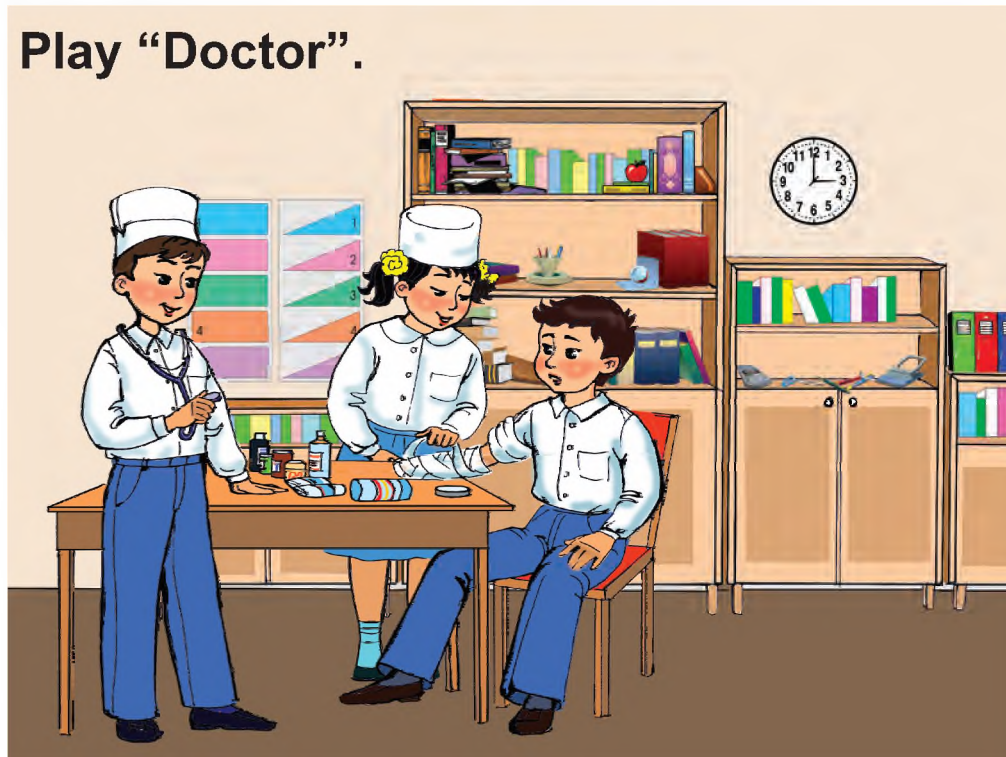

4  Play "Ski. Take a card".



Unit 8 The world around us

Lesson 1 What's the weather?

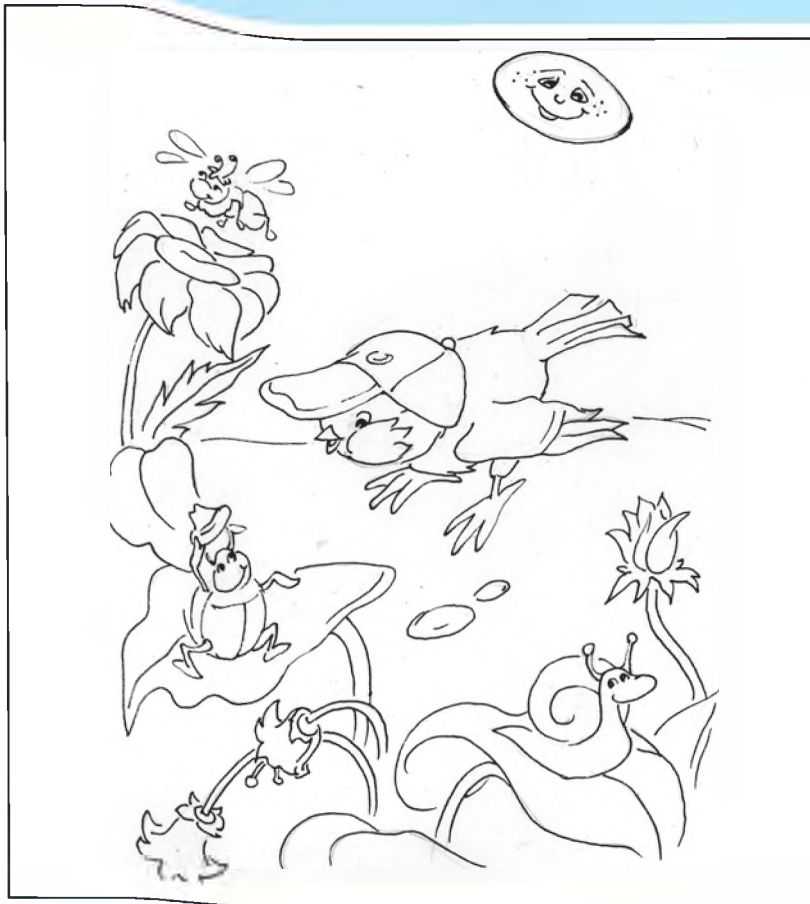

Ota-onalar uchun

Farzandingizdan avvalgi darsga qarab, quyidagi so'zlar ingliz tilida qanday aytilishini so'rang:

Quyoshli kun. (It's sunny.)

Qorli kun. (It's snowy.)

Bulutli kun. (It's cloudy.)

Shamolli kun. (It's windy.)

Rasmlarni bo'yashni va – *It's sunny (Quyoshli kun)* deb inglizcha aytishni so'rang.

Lesson 2 I can ski.

Farzandingizdan rasmni bo'yab tugatishini va "I can ski" deb aytishini so'rang.

Darsda o'rganilgan "I can skate" (Men konki ucha olaman), "I can play hockey" (Men xokkey o'ynay olaman) gaplarini aytishi kerakligini ayting.



Unit 8 The world around us

Lesson 3 I can fly a kite.

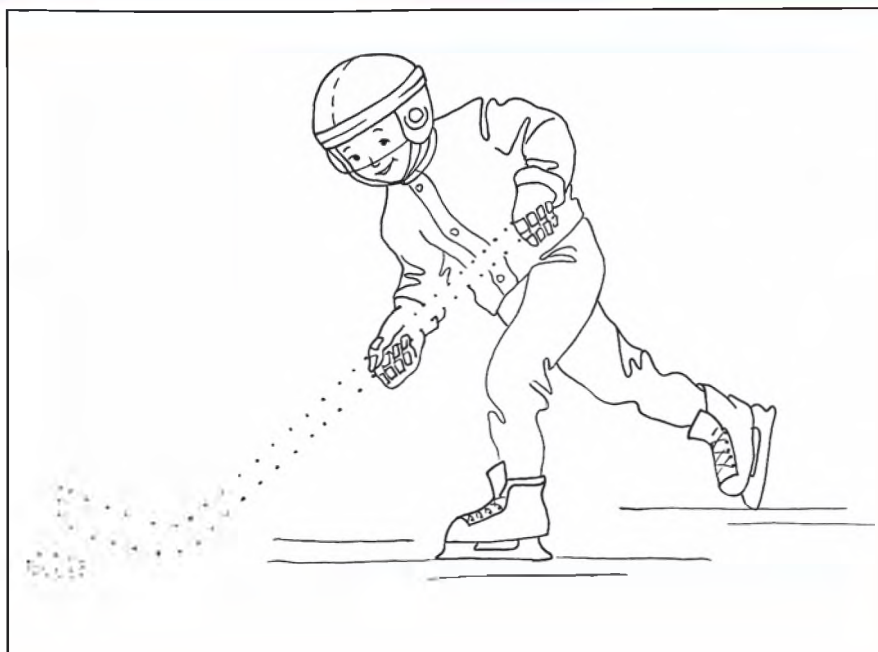

Ota-onalar uchun

Farzandingizdan rasmni bo'yab tugatishini va inglizchalab "I can play hockey" (Men xokkey o'ynay olaman) deb aytishini so'rang. Va darsda o'rganilgan gaplarni "I can ski" (Men chang'i ucha olaman), "I can skate" (Men konki ucha olaman) deb takrorlashi kerakligini ayting.

Lesson 4 Let's play!

Farzandingizga ilgari o'rganilgan uchta darsni qayta ko'rib chiqishini va takrorlash darsiga tayyorgarlik ko'rishi kerakligini ayting. Uy vazifasidagi rasmni bo'yab bo'lgach, "I can fly a kite" (Men varrak uchira olaman) gapini to'g'ri talaffuz qilishiga yordam bering.



Unit 9 Domestic animals

Lesson 1 I have a horse.

1



Play "Good afternoon".

2



Look, listen and repeat.



3



Play "It's grey".

4



Look and do.

5

Look and colour.

Unit 9 Domestic animals

Lesson 2 She has a sheep.

1



Look, listen and repeat.



2



Play "Look and guess".

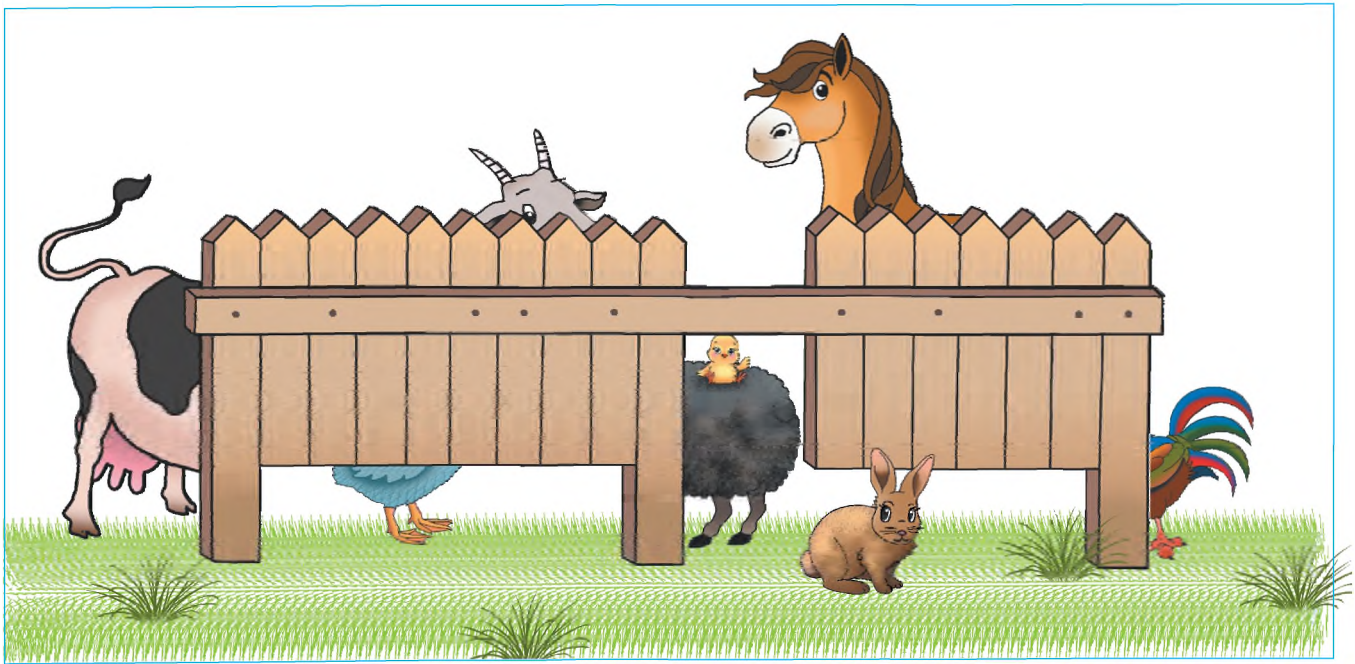

3

Look, listen and draw.

4

Look and say.

5



Play "She has a rabbit".

Unit 9 Domestic animals

Lesson 3 On the farm

1 Look, listen and sing.

2  Look, listen and repeat.



3  Look and do.

4   Play "Who says meeow?"



5  Play "He has a horse".

6   Draw and colour.

Unit 9 Domestic animals

Lesson 4 Let's play!

1  Listen and repeat.

2   Play "On the farm".



3  Look and do.

4  Play "Listen and raise hands".



5 Look and say.

Ota-onalar uchun

Farzandingizga ilgari o'rganilgan uchta darsni qayta ko'rib chiqishini va takrorlash darsiga tayyorgarlik ko'rishi kerakligini ayting.

Unit 9 Domestic animals

Lesson 1 I have a horse.

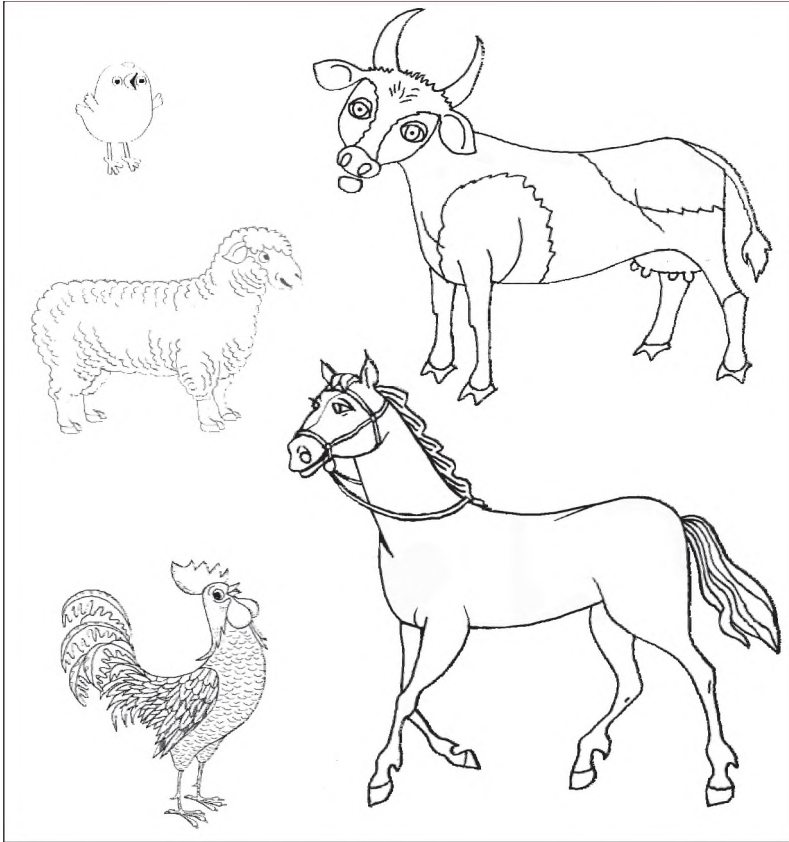

Ota-onalar uchun

Farzandingizdan hayvonlar rasmini bo'yashini va rasmlardagi hayvonlar nomlarini takrorlashini so'rang: a cow (sigir), a sheep (qo'y), a horse (ot), a rooster (xo'roz), a chick (jo'ja).



Lesson 2 She has a sheep.

Farzandingizdan hayvonlar rasmini bo'yashini va ularning nomlarini takrorlashini so'rang: a rabbit (quyon), a duck (o'rdak). Quyidagi gaplarni eslashiga yordam bering: *She has a rabbit. It's brown (Uning quyoni bor. U jigarrang). He has a duck. It's blue (Uning o'rdagi bor. U ko'krangda).*



Unit 9 Domestic animals

Lesson 3 On the farm

Ota-onalar uchun

Farzandingizdan hayvonlar rasmini chizishini, uni bo'yashini va ular haqida gaplar tuzishini so'rang. Masalan: "I have a cow. It's black."

Farzandingiz o'z xohishiga ko'ra biror hayvonning rasmini chizishi, bo'yashi va gaplar aytishi mumkin. Masalan: "I have a horse. It's brown."

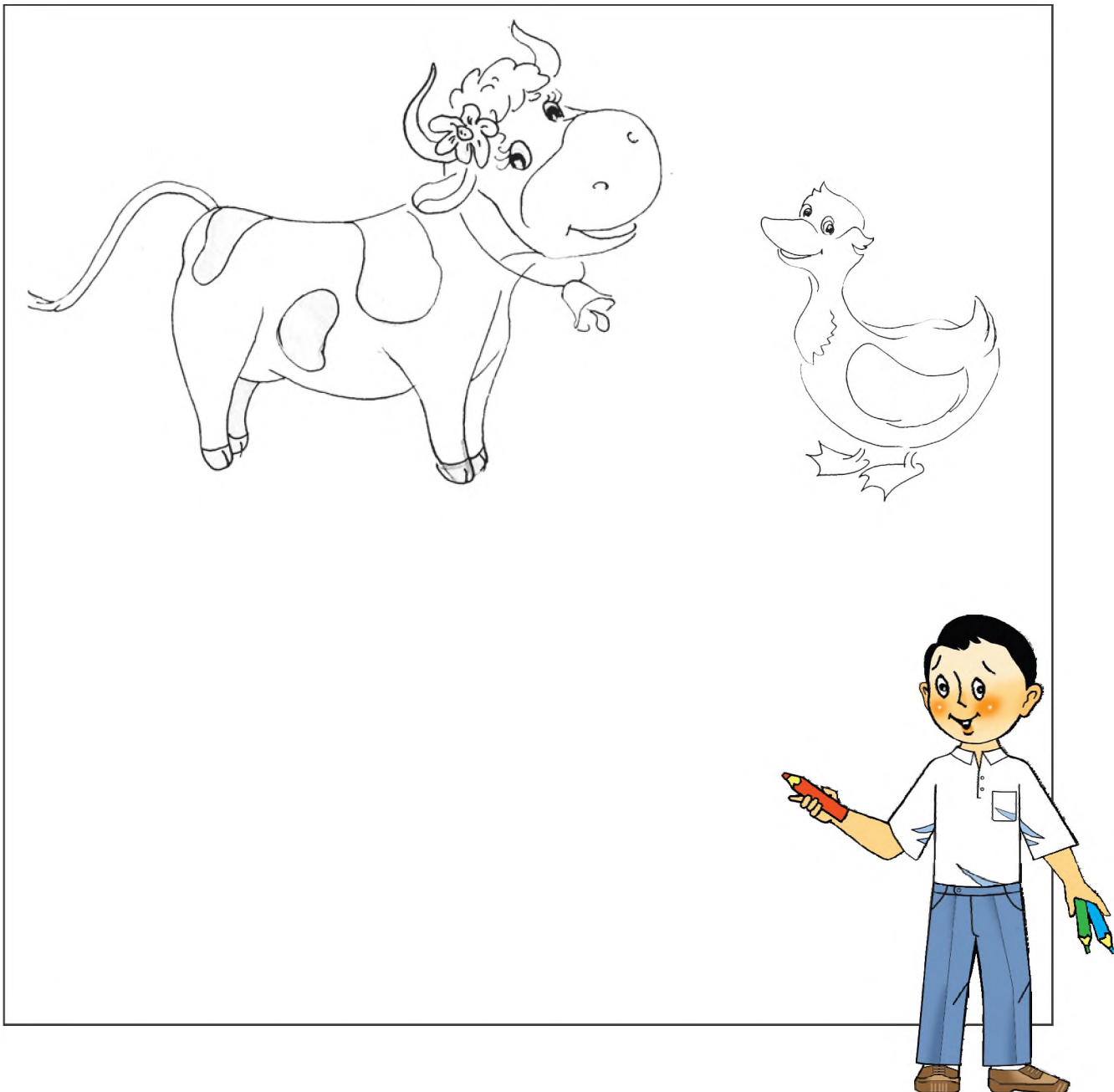

Revision 5

1 Sing a song.

2 Look, listen and number.

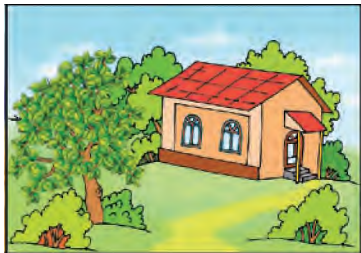
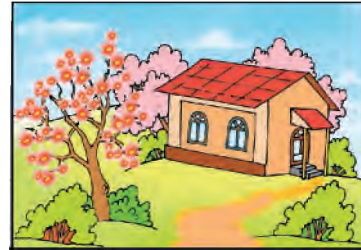
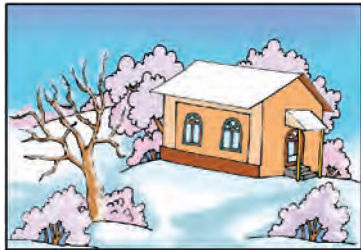

3  Look and do.

4 Play "Choose and say".



Unit 10 Wild animals

Lesson 1 I'm a tiger.

1  Listen and repeat.

2 Look, listen and say.



3 Look and say.

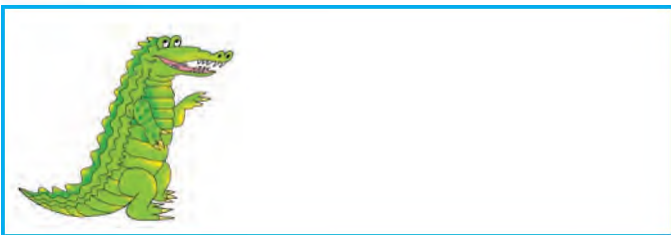

4   Look and do.

5  Play "Show and say".



Unit 10 Wild animals

Lesson 2 I have two wings.

1  Listen and say.

3  Look and do.

2  Play "What's this?"

4a  Look, listen and say.



4b  Play "I have four legs".

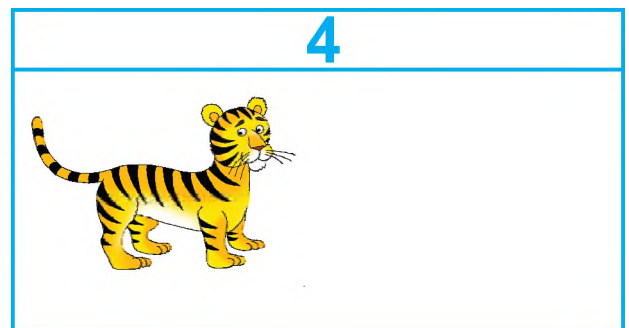
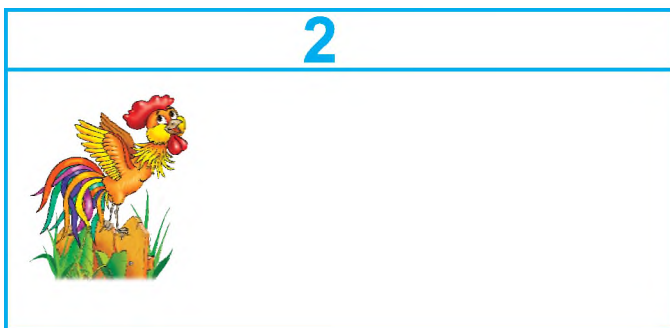

5   Play "I'm a tiger".

Unit 10 Wild animals

Lesson 3 In the zoo

1



Listen and say.

2



Play "Look and guess".

3



Look and do. **4a** Look, listen and repeat.

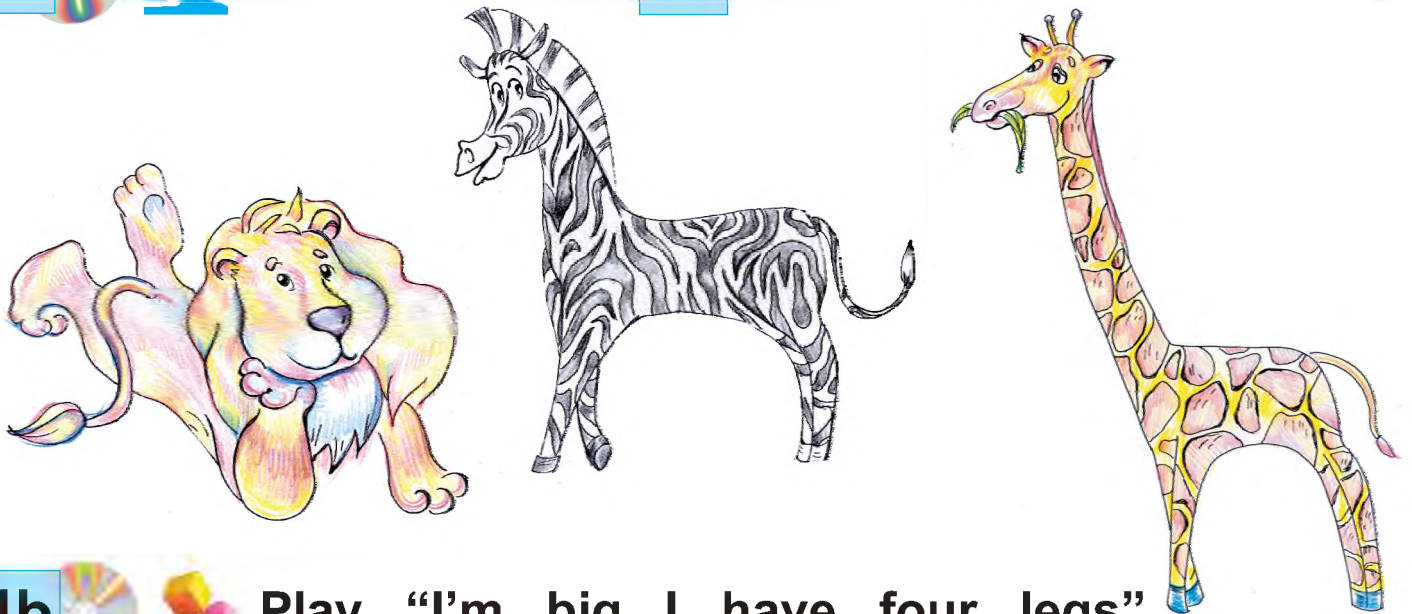

4b



Play "I'm big. I have four legs".



5



Play "I'm a crocodile".

Unit 10 Wild animals

Lesson 4 Let's play!

1



Look, listen and sing.

2

Look and say.



	✓				✓	✓
		✓	✓	✓		

3



Look and do.

4



Play "True/False".

5



Play "I have a spider on my head".



6



Look and say.

Unit 10 Wild animals

Lesson 1 I'm a tiger.



Ota-onalar uchun

Farzandingizdan hayvonlar rasmini bo'yashini va ular haqida gaplar aytishini so'rang. Ular xuddi sinfda gapirgandek gapirishsin. Masalan: *I'm a tiger. I'm big. I'm orange and black (Men yo'lbarsman. Men kattaman. Mening rangim olovrang va qora)* va h.k.

Lesson 2 I have two wings.

Farzandingizga xo'roz va to'tiqushning rasmini chizishi kerakligini va ular haqida gaplar aytishi kerakligini tushuntiring.

Masalan: *I'm a parrot. I'm little. I have two wings. I can fly (Men to'tiqushman. Men kichkinaman. Mening ikkita qanotim bor. Men ucha olaman).*

Farzandingizga qushlarning oyog'i va qanotlarini sanashida yordam bering.



Unit 10 Wild animals

Lesson 3 In the zoo

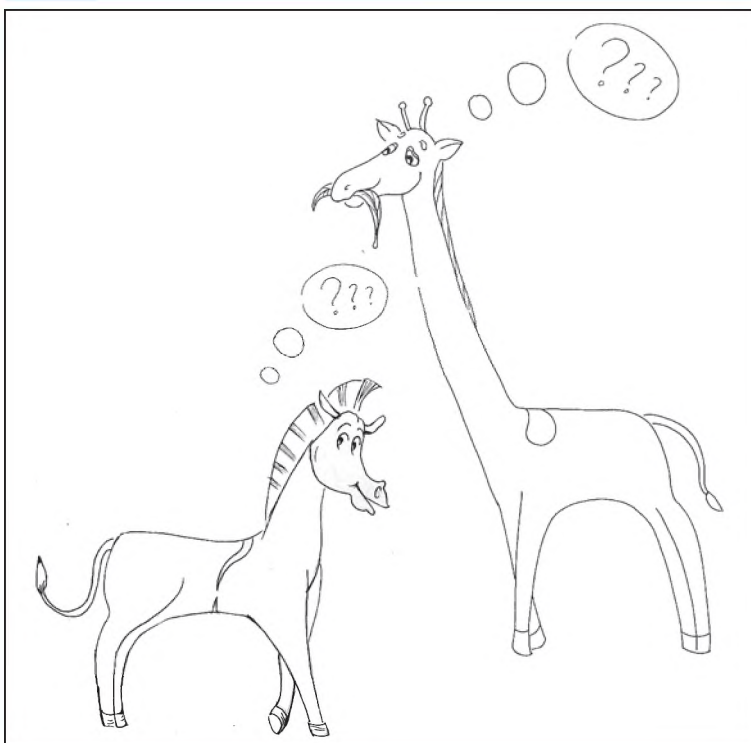

Ota-onalar uchun

Farzandingizdan jirafa va zeb-raning yo'qotgan ranglarini o'z joylariga qaytarishiga yordam berishini so'rang. Hayvonlarni bo'yashda va ular haqida gap tuzishda unga yordam bering. Masalan: *I'm a zebra. I'm big. I'm black and white. I have four legs. I can run.*

Lesson 4 Let's play!

Farzandingizdan hayvonot bog'ining rasmiga qarashini so'rang. Hayvonlarni bo'yashda va ular haqida gap tuzishda unga yordam bering. Masalan: *I'm a bear. I'm big. I'm brown. I have four legs. I can run. (Men ayiqman. Men kattaman. Men jigarrangman. Mening to'rtta oyog'im bor. Men yugura olaman).*

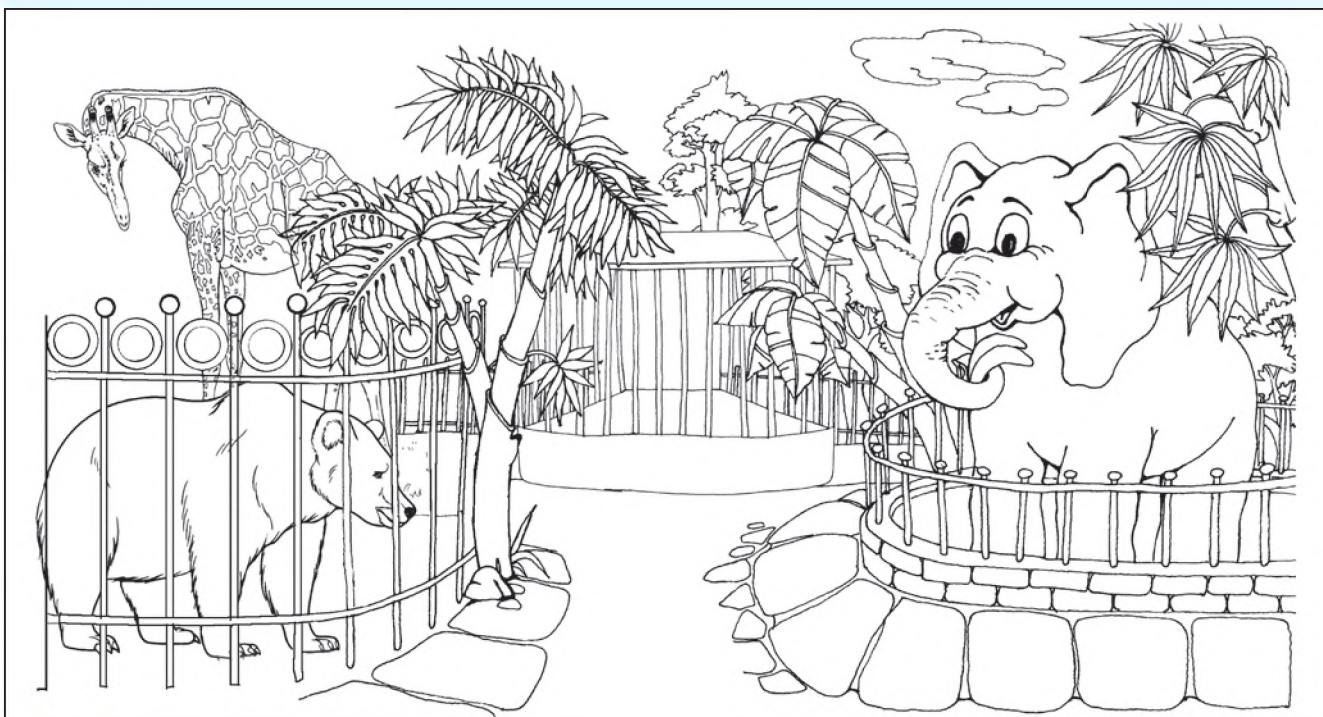

Unit 11 Vegetables

Lesson 1 It's a carrot.

1  Look, listen and repeat.



2  Play "What's this? Tomato."

3  Play "Number 4. It's a carrot".

4  Look and count.

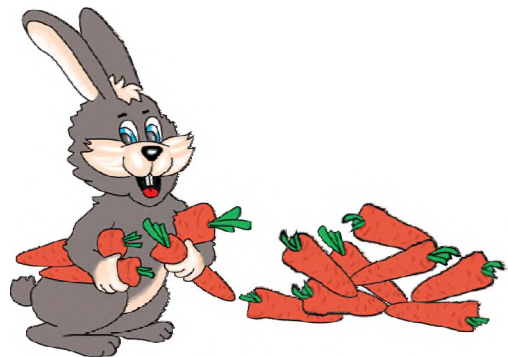

5   Play "More. Less."

6   Look, listen and number.

Unit 11 Vegetables

Lesson 2 Is it a cucumber?

1 Look and say.

2 Look, listen and say.

3  Play "Guess".



4  Play "Count".

5 Look, listen and repeat.

10

20

30

40

50

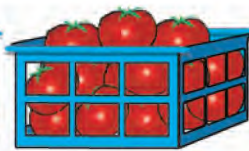
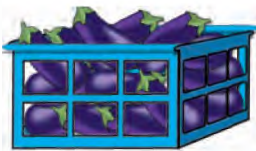

6  Listen and number.

Unit 11 Vegetables

Lesson 3 I have pumpkins.

1 Look and say. 2 Look, listen and repeat.

3   Play "Tic Tac Toe".

4  Look, listen and repeat.

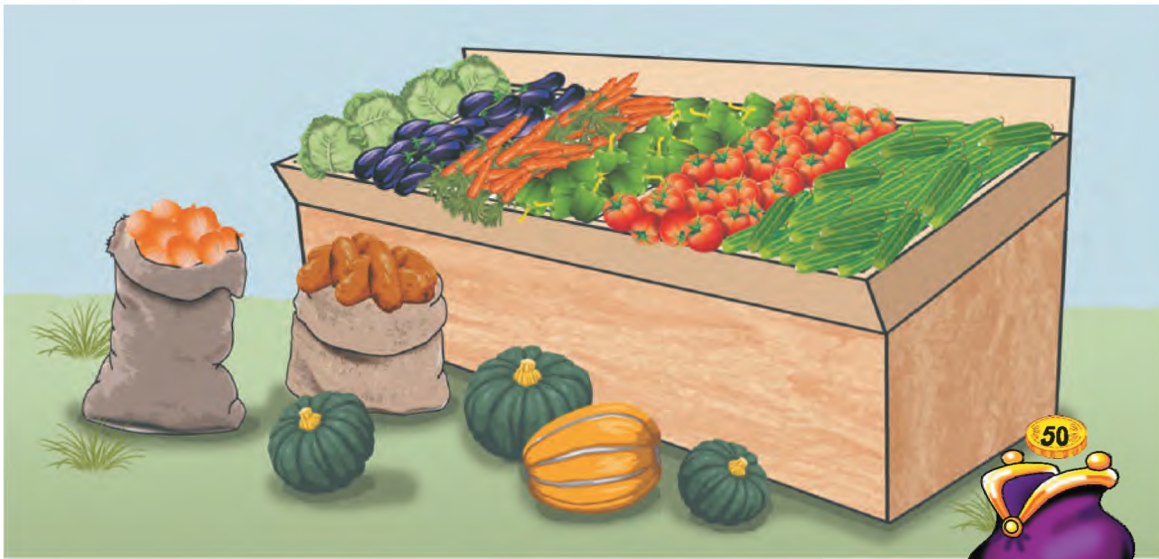

5  Look and do.



6   Play "How much?"

Unit 11 Vegetables

Lesson 4 Let's play!

1 Look and say.

2  Play "Funny race".



3 Look and say.

4  Look and do.



5  Look and count.



Ota-onalar uchun

Farzandingizga ilgari o'rganilgan uchta darsni qayta ko'rib chiqishini va takrorlash darsiga tayyorgarlik ko'rishi kerakligini ayting.

Unit 11 Vegetables

Lesson 1 It's a carrot.

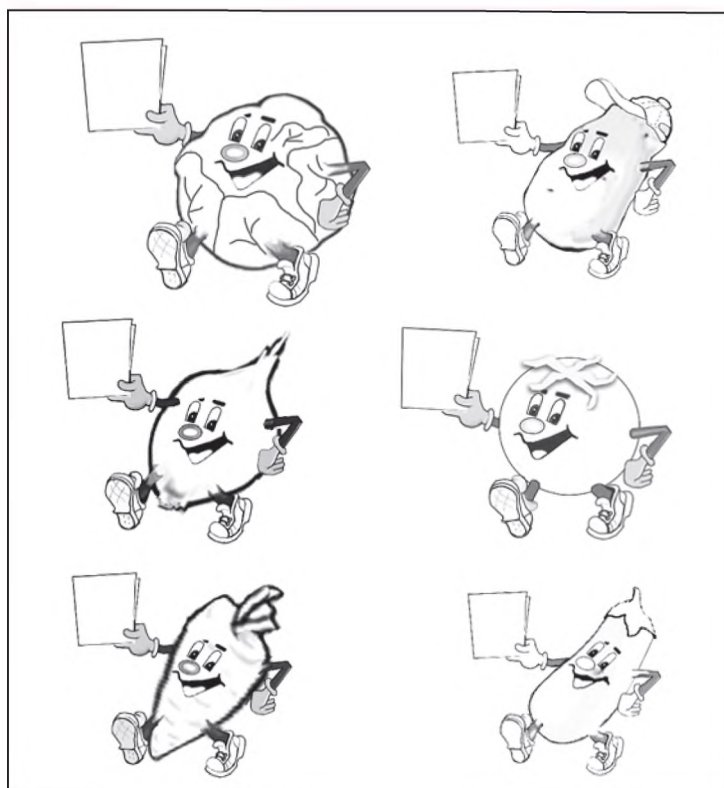

Ota-onalar uchun

Farzandingizdan sabzavotlarni bo'ya-shini va xuddi sinfda gapirgandek ular haqida gaplar tuzishini so'rang. Masalan: *This is a tomato. It's red,* va h.k.



Lesson 2 Is it a cucumber?

Ota-onalar uchun

Farzandingizdan sabzavotlarni bo'ya-shini va xuddi sinfda gapirgandek ular haqida gaplar tuzishini so'rang. Masalan: "Potato.20", "Eggplant.30", "Cucumber.40", "Carrot.50", "Onion.10"

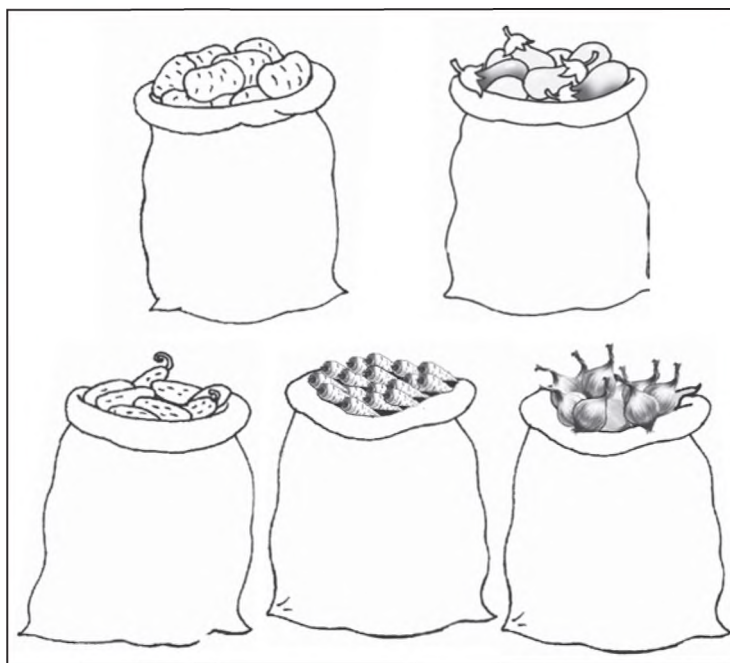

Unit 11 Vegetables

Lesson 3 I have pumpkins.



Ota-onalar uchun

Farzandingizdan sabzavotlarni bo'yab tugatishini va xuddi sinfda gapirgandek ular haqida gaplar tuzishini so'rang. Masalan: *This is a carrot. It's orange.*

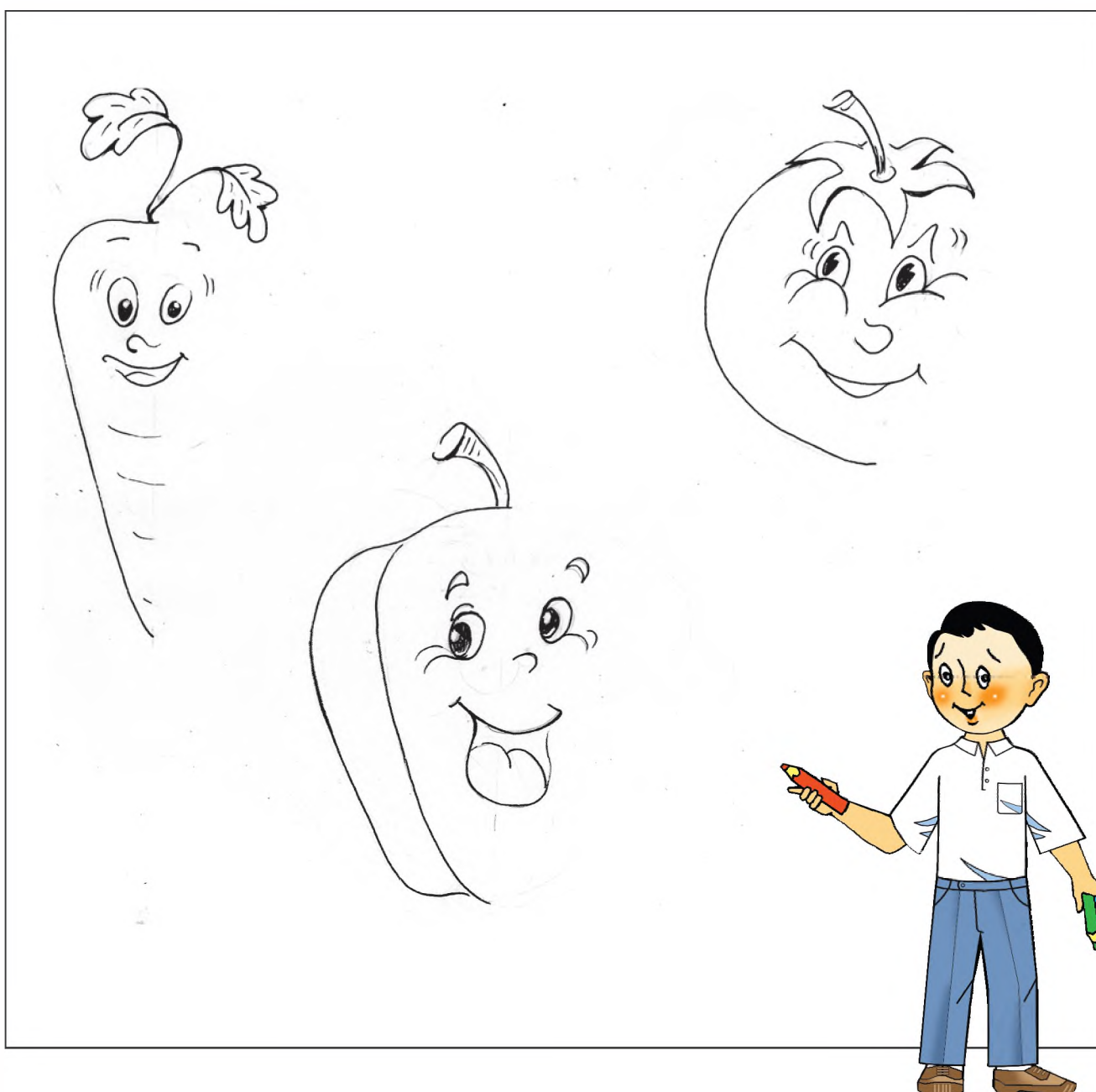

Revision 6

1 Sing a song.

2 Look, listen and put number.

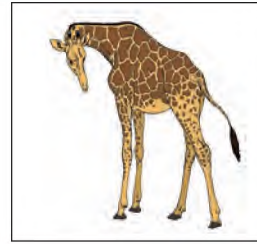
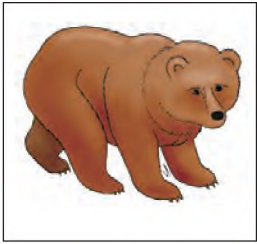

3  Look and do.

4 Look, listen and match.

10

20

30

40

50



Unit 12 Fruit

Lesson 1 I like apples.

1a  Look, listen and say.

1b Look, listen and repeat.



2   Play "Miming".

3  Play "Ask and answer".



4  Look and do.

5  Look, listen and number.

Unit 12 Fruit

Lesson 2 Is it a fruit?

1  Look, listen and repeat.

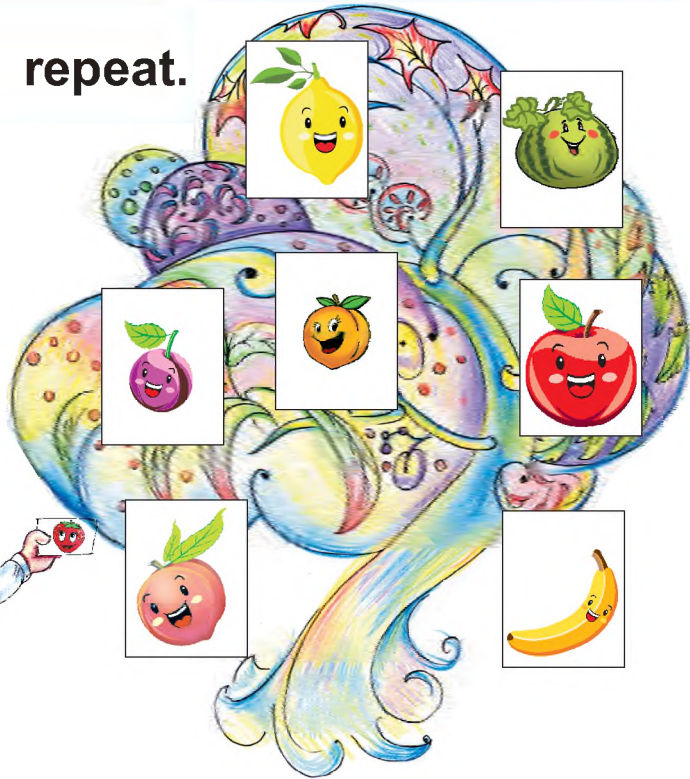
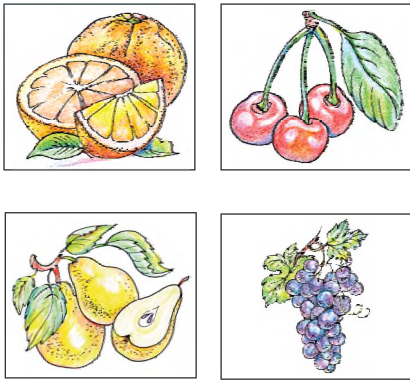

2  Listen and say.

3  Look, listen and repeat.

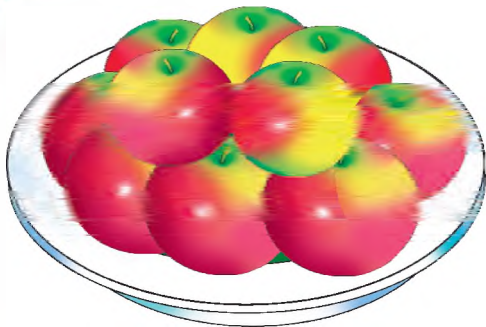

4  Play "What number is missing?"

5a  Play "Fruit. Vegetables".

5b  Play "Is it a fruit?"

Unit 12 Fruit

Lesson 3 At the market

1  Listen and say.

2  Look and count.

3   Play "Listen, run and touch."

4a Look, listen and repeat.

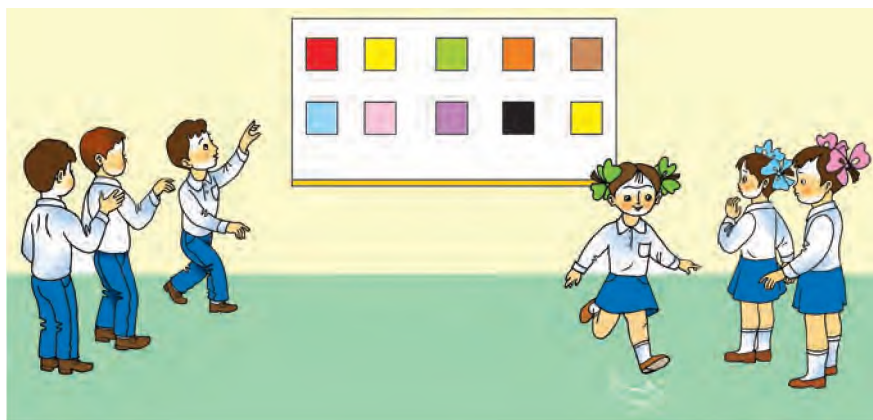

4b   Play "At the market".



4c   Look and say.

Unit 12 Fruit

Lesson 4 Let's play!

1a  Listen and repeat.

1b Choose and say.

2   Play "Count".

3  Play "Look, listen and do."



4  Play "Shopping".



5  Play "What's this?"

Ota-onalar uchun

Farzandingizga ilgari o'rganilgan uchta darsni qayta ko'rib chiqishini va takrorlash darsiga tayyorgarlik ko'rishi kerakligini ayting.

Unit 12 Fruit

Lesson 1 I like apples.



Ota-onalar uchun

Farzandingizdan ho'l mevalarni bo'yashini va xuddi sinfda gapirgandek ular haqida gaplar tuzishini so'rang. Masalan: *I have plums. I like plums* (Menda olxo'rilar bor. Men olxo'rilarni yaxshi ko'raman).

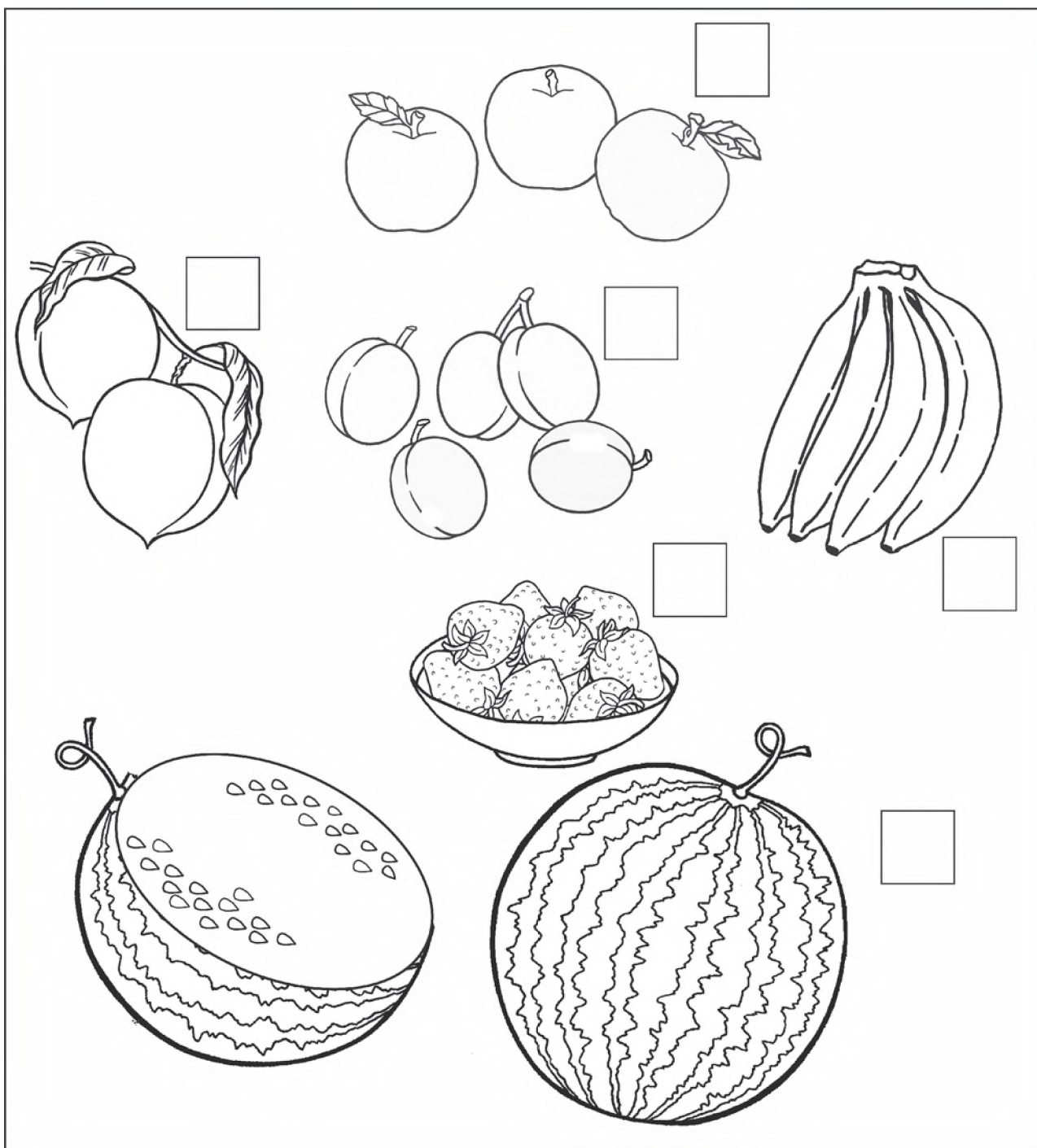

Unit 12 Fruit

Lesson 2 Is it a fruit?



Ota-onalar uchun

Farzandingizdan ho'l mevalarni bo'yashini va xuddi sinfda gapirganidek ular haqida gaplar tuzishini so'rang. Masalan: *Fourteen bananas* (o'n to'rtta banan), *fifteen oranges* (o'n beshta apelsin), *sixteen apricots* (o'n oltita o'rik), *seventeen plums* (o'n yettita olxo'ri), *eighteen strawberries* (o'n sakkizta qulupnay), *nineteen cherries* (o'n to'qqizta olcha).

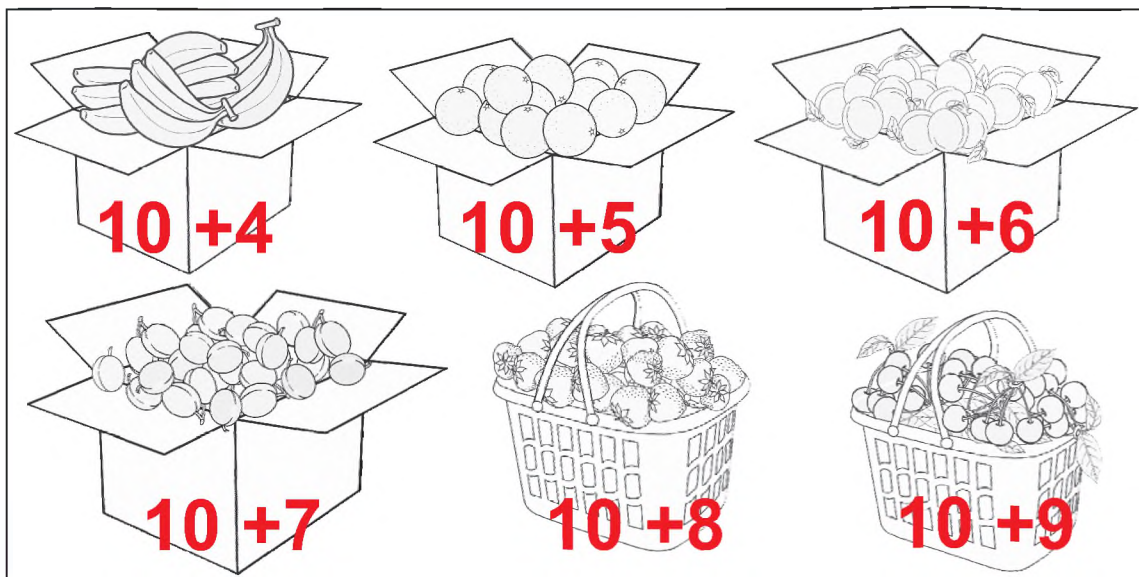

Lesson 3 At the market

Ota-onalar uchun

Farzandingizdan ho'l mevalarni bo'yashini va xuddi sinfda gapirganidek ular haqida gaplar tuzishini so'rang. Masalan: *I have nineteen plums* (Menda o'n to'qqizta olxo'ri bor), *I have six oranges* (Menda oltita apelsin bor), *I have three watermelons* (Menda uchta tarvuz bor). *I have fifteen cherries* (Menda o'n beshta olcha bor). *I have eight bananas* (Menda sakkizta banan bor).

Eslatma: 7-takrorlash darsi o'qituvchilar uchun metodik qo'llanmada berildi.

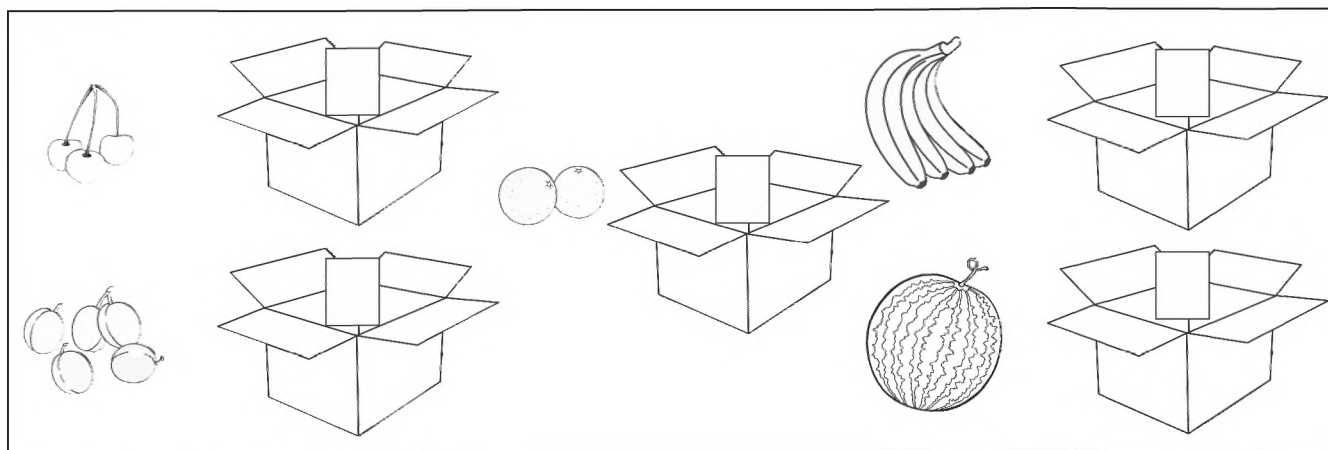

Unit 13 Things we can do

Lesson 1 I can draw a cat.

1  Listen and repeat.

2 Look, listen and repeat.



3  Play "I can draw a cat".

4  Look and do.

5  Play "I can see a red crocodile".

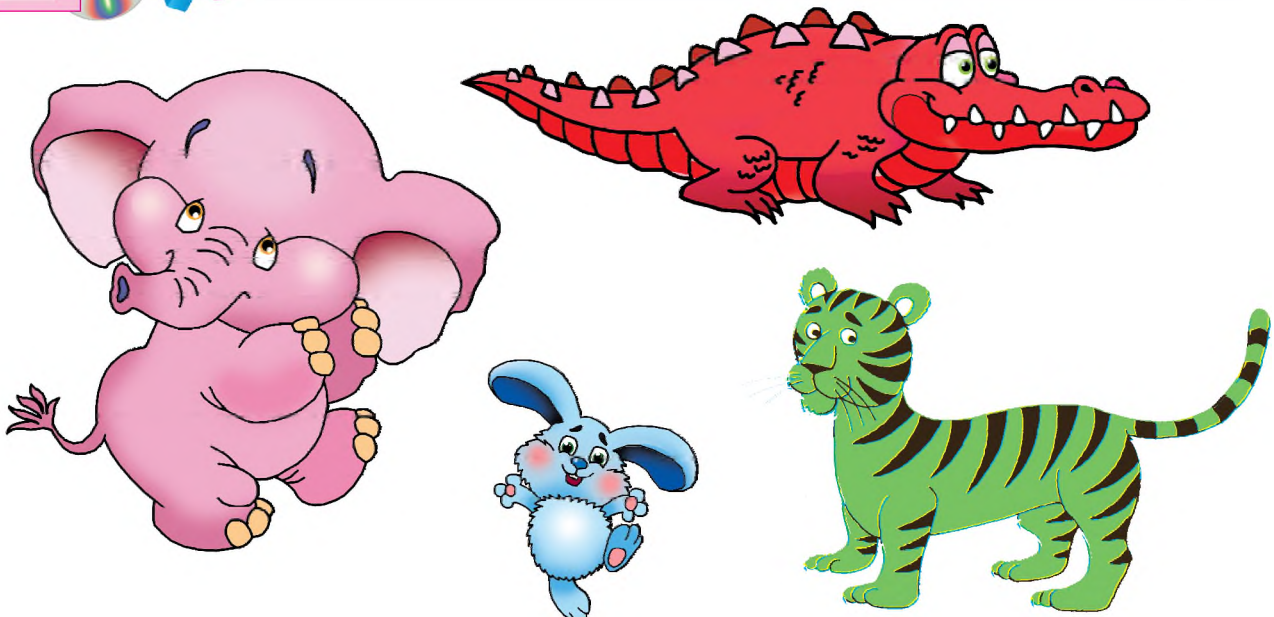

Unit 13 Things we can do

Lesson 2 I can count.

1



Listen and repeat.

2a

Look and count.

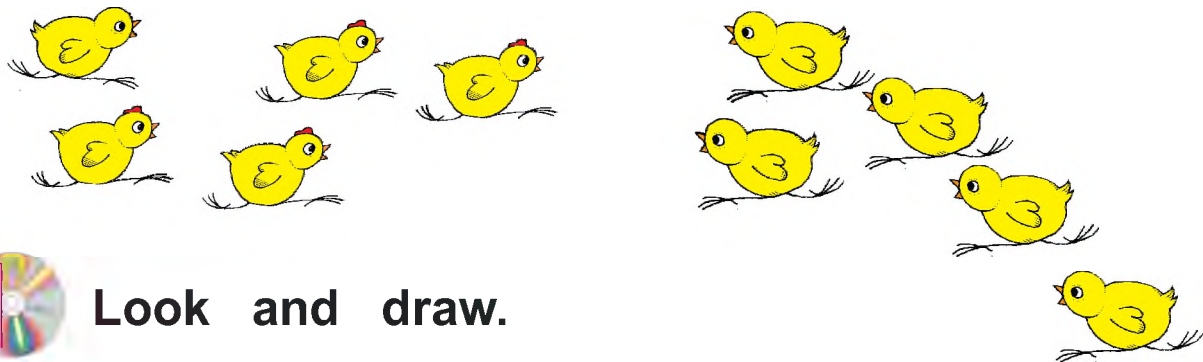

2b



Look and draw.

3



Play "I can count".

4a



Look, listen and repeat.

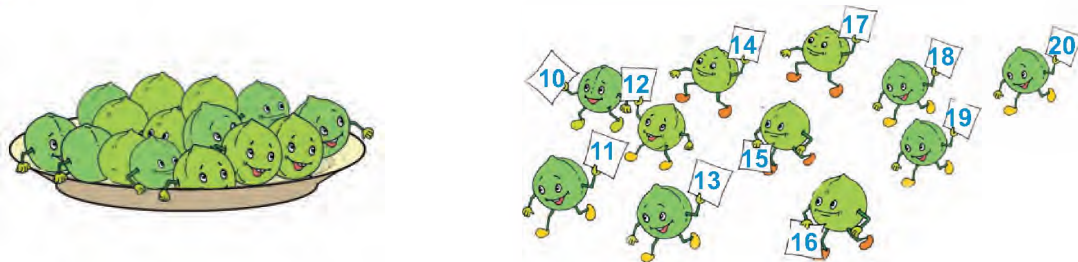

4b



Play "Let's count".

5



Play "Seasons".

Unit 13 Things we can do

Lesson 3 We can play.

1



Listen and repeat.

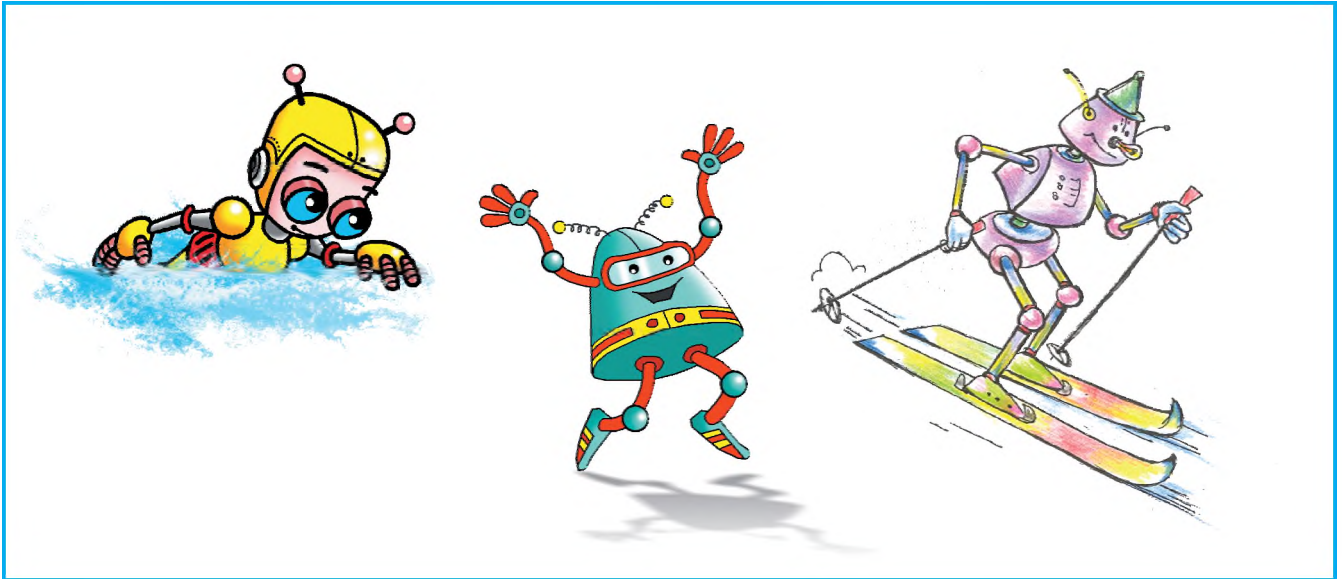

2



Look, listen and repeat.

3



Look and do.

4



Play "Animal race".



Unit 13 Things we can do

Lesson 4 Let's play!

1  Play "I can".

2  Play "Little frog".

3a Look and count.

3b  Look and listen.



3c  Look, listen and perform.

Ota-onalar uchun

Farzandingizga ilgari o'rganilgan uchta darsni qayta ko'rib chiqishini va takrorlash darsiga tayyorgarlik ko'rishi kerakligini ayting.

Unit 13 Things we can do

Lesson 1 I can draw a cat.



Ota-onalar uchun

Farzandingizdan hayvonlarni noodatiy ranglar bilan bo'yashini va ular ishtirokida xuddi sinfda bajarganidek gaplar tuzishini so'rang. Masalan: *I can see a blue bear* (Men ko'k ayiqni ko'ra olaman).

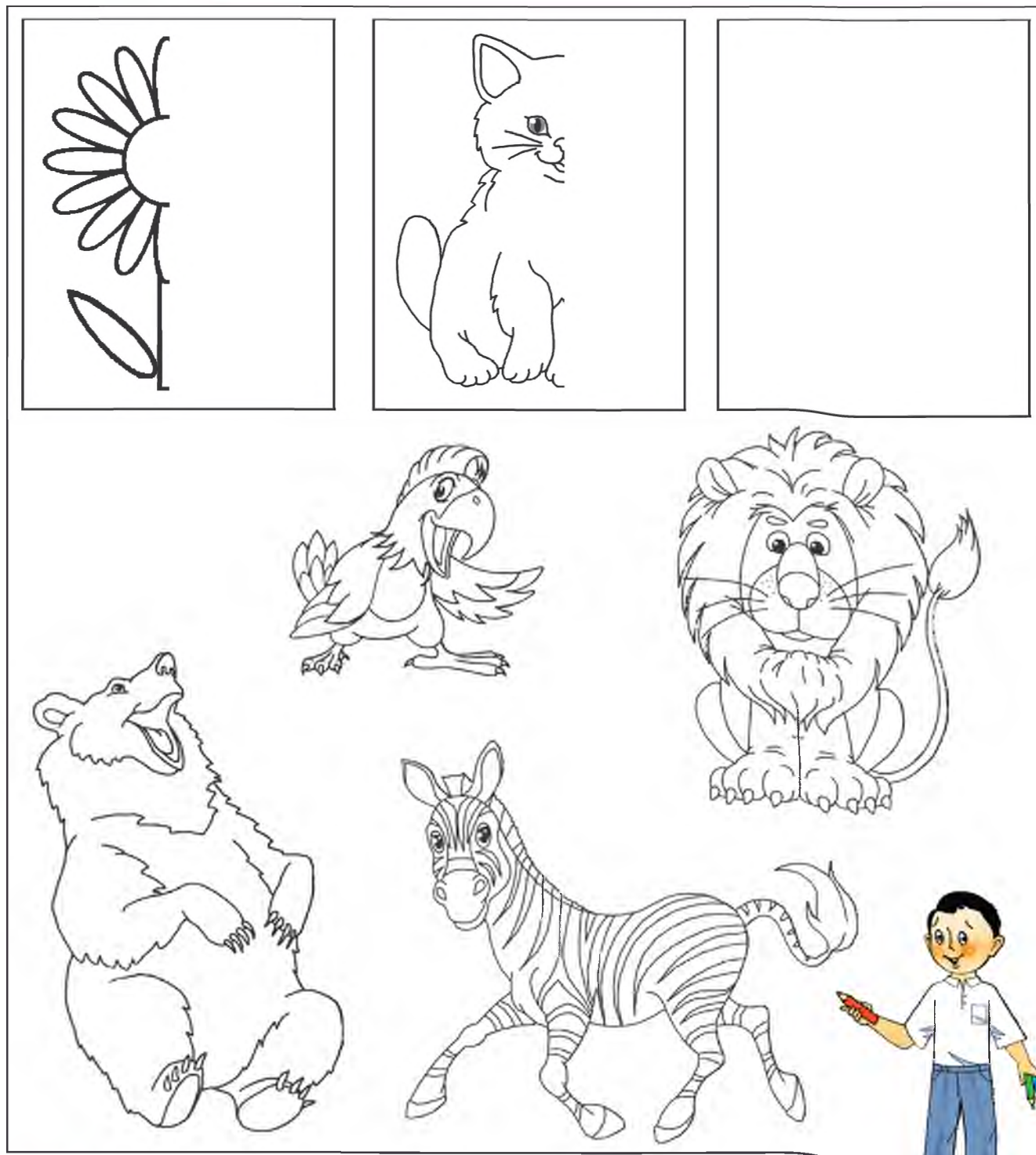

Unit 13 Things we can do

Lesson 2 I can count.

Ota-onalar uchun



1-uy vazifasi: Farzandingizdan rasmlarni chizib tugallashini, ularni bo'yashini va ular ishtirokida xuddi sinfda bajarganidek gaplar tuzishini so'rang. Masalan: *I can draw a cow (Men sigir rasmini chiza olaman). I have two cows (Mening ikkita sigirim bor).*

2-uy vazifasi: Farzandingizdan rasmni bo'yashni tugatishini va yil fasllarini tasvirlash uchun gaplarni eslashini so'rang. Masalan: *It's spring (Hozir bahor). It's green (U yashil). It's rainy (U yomg'irli).*

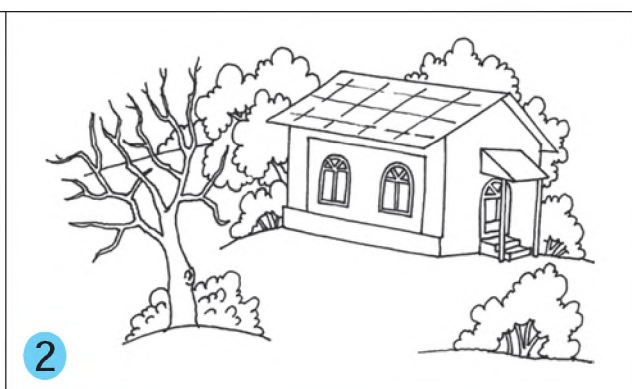
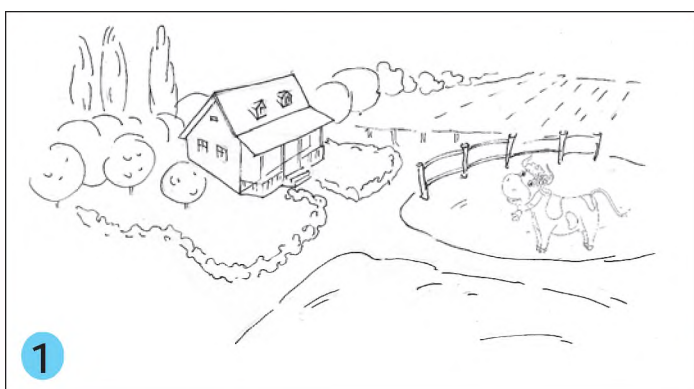

Lesson 3 We can play.

1-uy vazifasi: Farzandingizdan sinfda chizgan rasmini bo'yashini so'rang.

2-uy vazifasi: Farzandingizdan sahifaning pastki qismidagi to'rtburchak ichiga o'ziga yoqqan rasmni chizishini so'rang. Masalan: *Sevimli o'yinchog'i, o'zi yoqtirgan yil fasli, o'zi yoqtirgan hayvoni va h.k. O'zi chizgan rasmlari haqida gapirib berishini so'rang. Masalan: "I like spring." yoki "I like cars."*

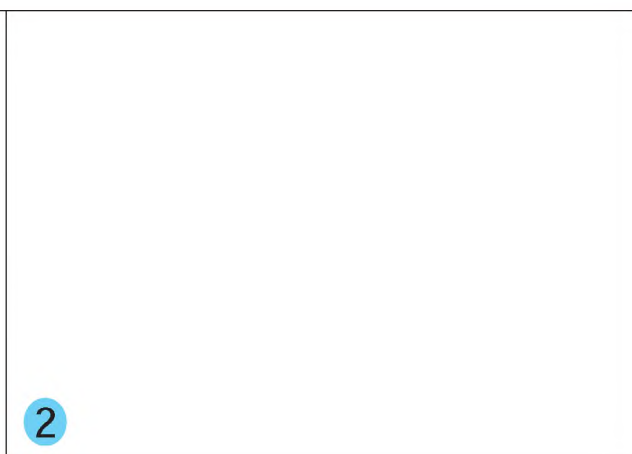
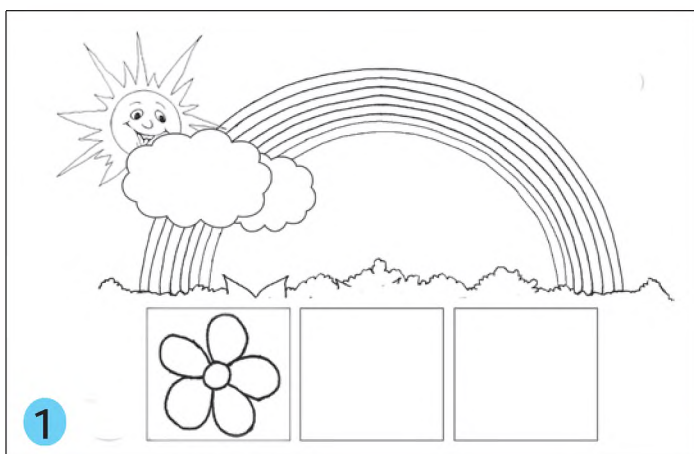

Revision 8

1 Sing a song.

2  Look, listen and tick.

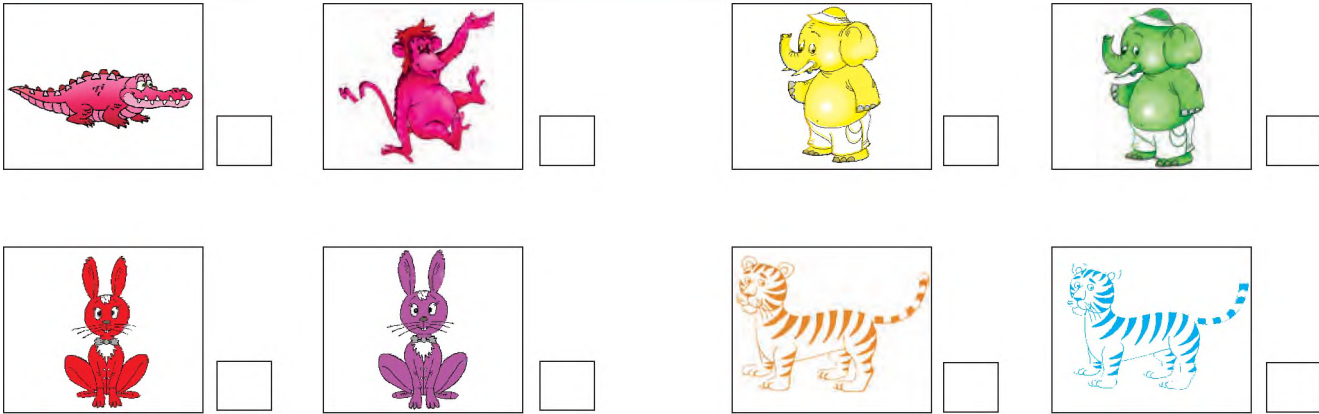

3 Look, find and count.



4 Look, listen and circle.

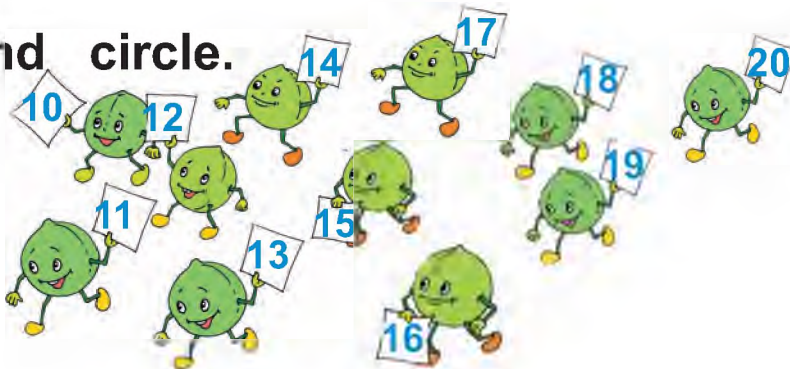

5  Play "Competition".

Unit 14 Fairy world

Lesson 1 I have a magic wand.

1



Play "Magic colours".



2



Play "Magic wand".



3



Look and do.

4



Play "I'm Jinn".

5



Play "Magic lamp".

6



Play "Magic box".



Unit 14 Fairy world

Lesson 2 Magic watermelon

1a Look and say.

1b Look, listen and say.

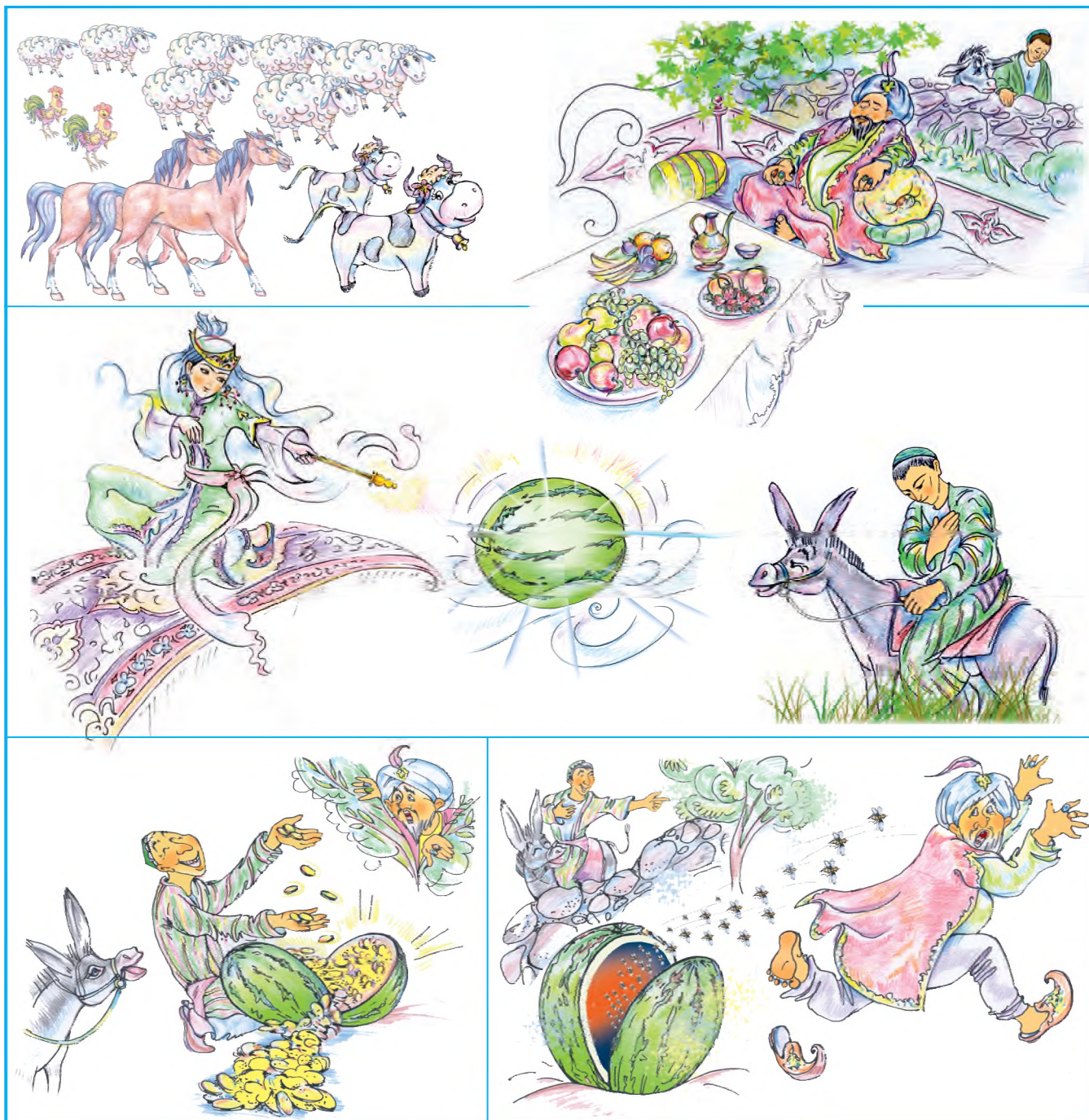

2 Perform and watch.

Unit 14 Fairy world

Lesson 3 Little Mook

1 Look and count.



2 Look and answer.



3 Look, listen and match.

Unit 14 Fairy world

Lesson 4 Let's play!

1  Look and say.



2 Perform and watch.

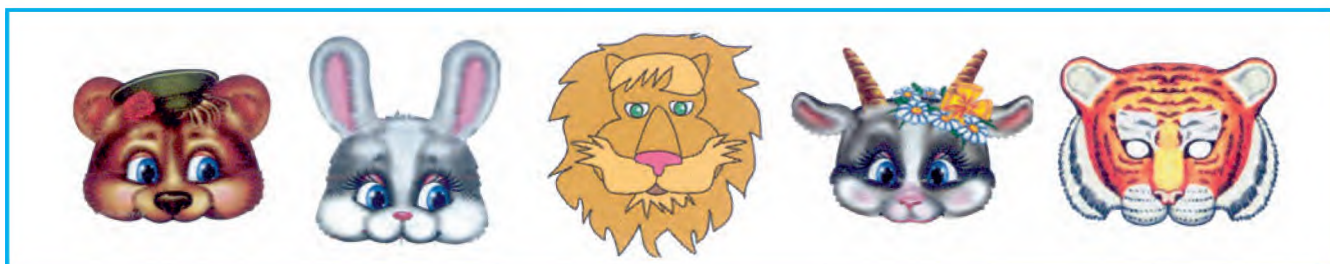

Ota-onalar uchun

Farzandingizga ilgari o'rganilgan uchta darsni qayta ko'rib chiqishini va takrorlash darsiga tayyorgarlik ko'rishi kerakligini ayting.

Unit 14 Fairy world

Lesson 1 I have a magic wand.

Ota-onalar uchun

Farzandingizdan rasimli jadvalga qarashini so'rang va har bir rasm haqida gaplar tuzishi kerakligini ayting. Masalan: *I have a kite. It's red and yellow.* (Menda varrak bor. U qizil va sariq.)

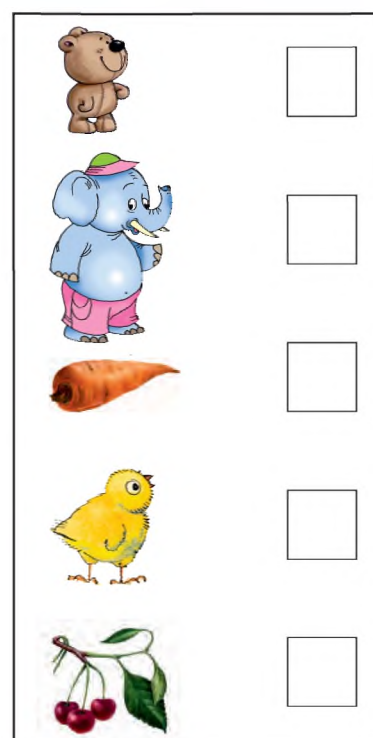
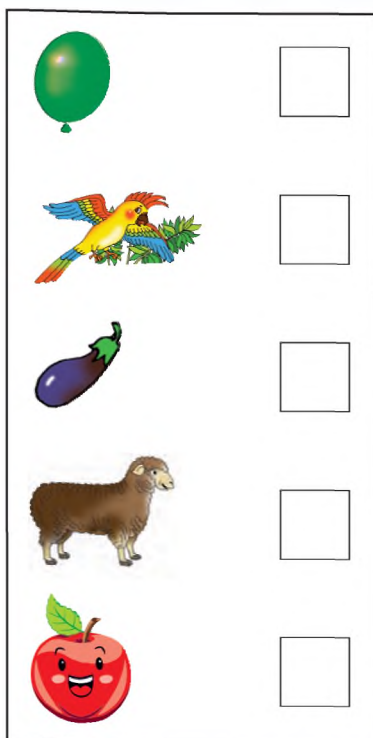
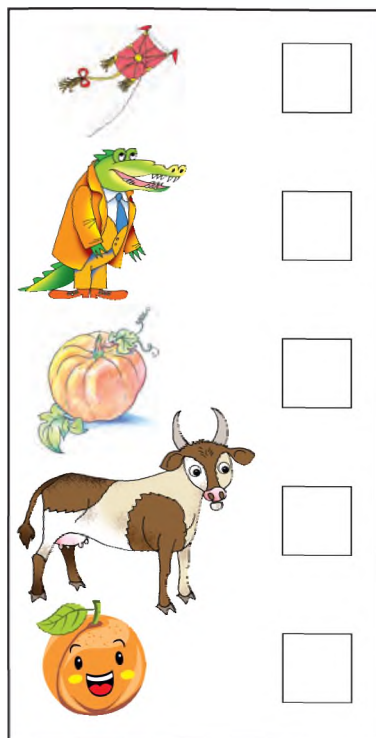

Unit 14 Fairy world

Lesson 2 Magic watermelon

Ota-onalar uchun

Farzandingizga rasmlarni bo'yashini va ertakni eslashi kerakligini ayting. Masalan: *This is Peri. She's good. She has a magic wand.* (Bu Pari. U yaxshi. Unda sehrii tayoqcha bor.) Ertakdagi rasmlarni tartib bilan raqamlab chiqishiga ko'maklashing va nega shunday raqamlagani haqida suhbatlashing. Shundan so'ng rasmlarni bo'yashiga yordam bering.

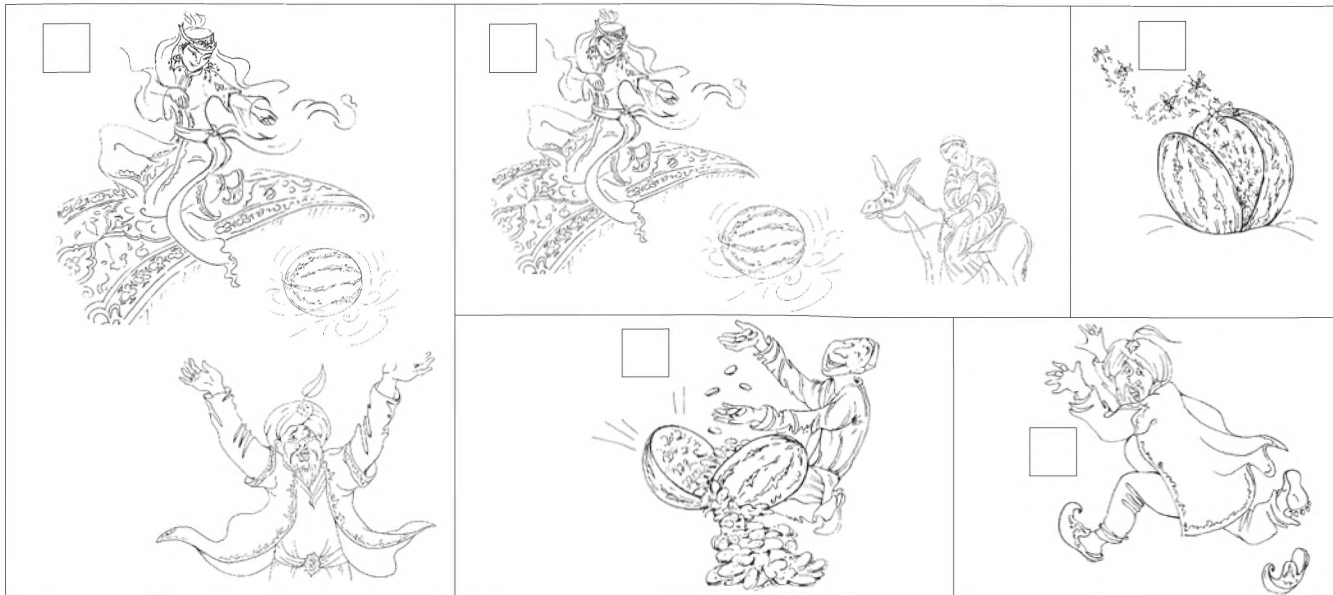

Lesson 3 Little Mook

Ota-onalar uchun

Farzandingizdan kichkintoy Mukning rasmini chizishni va u haqida xuddi sinfda gapirganidek gaplar tuzishini so'rang. Masalan: *Little Mook has long ears.* (Kichkintoy Mukning quloqlari katta.)

Eslatma: Keyingi darsga hayvonlar niqobini olib borishi kerakligini yodiga soling.



Revision 9

1 Sing a song.

2 Look, colour and say.

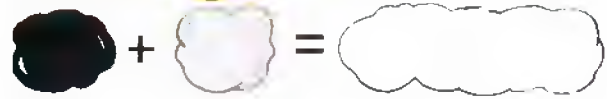
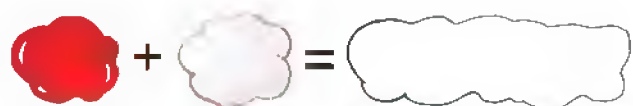

3 Look and say.

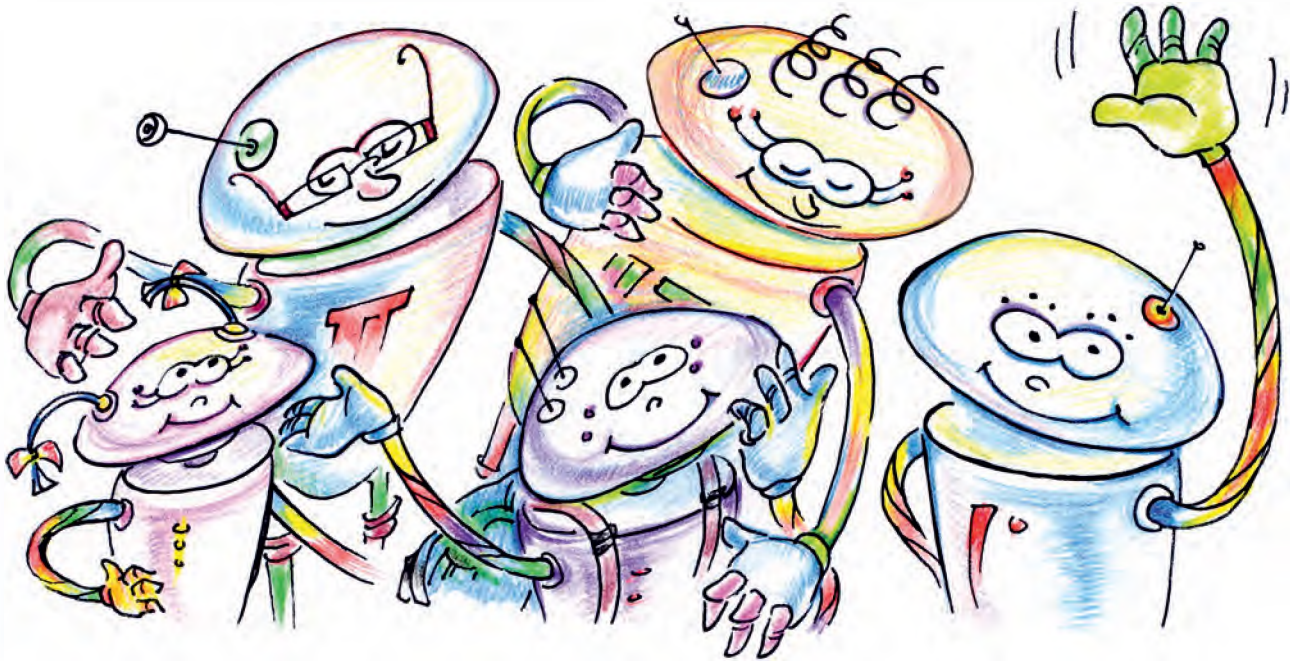

4  Look and do.

5  Play "True/False".

Hurmatli o'qituvchilar va ota-onalar!

Farzandlarimiz bizga doimo: bu nima, nega, nima uchun kabi savollar berib, olamni o'rganib boradilar... Bizning vazifamiz faqat bu savollarga javob berishdan iborat bo'lmagan, farzandlarimizni yanada ko'proq savollar berishga yo'naltirish, ularning dunyoqarashlari hamda aqliy salohiyatlarini o'stirib va boyitib borishlariga ko'maklashishdan iborat.

96–104-sahifalarda berilgan savollarni birinchi sinf o'quvchilari tushunishlari, savollar berishni va ularga javoblar bera olishni o'rganishlari lozim. «What's this?» (Bu nima?) kabi savollar ikkinchi bo'limdan boshlab, darslikda bo'limdan bo'limga takrorlanib boradi. «Is it a pen?» (Bu ruchkani?) kabi savollarga «Yes./No.» (Ha./Yo'q.) tarzida qisqa javob berish kifoya ekanligiga ahamiyat bering.

Keyingi sahifalarda har bir bo'lim uchun alohida berilgan materiallar shu bo'lim davomida o'rganilgan so'z, so'z birikmalari hamda qurilmalarni o'z ichiga olgan. Undagi rasmlar so'z va iboralarni jadvallardagi savol va javoblarda ishlatishingiz va bolajonlar bilan ingliz tilida ko'proq mashq qilishingiz lozim.

Jadvallarda yulduzcha bilan ajratib berilgan ayrim qo'shimcha savol va javoblar ham keltirilgan. Siz bu savollarni bolalardan so'rashingiz mumkin. Bolalar ularni qanday so'rashni o'rganishlari shart bo'lmasa-da, ularni tushunishlari va tegishli javob qaytara olishlari lozim. Masalan, Siz «Where is a pen?» (Ruchka qayerda?) deb so'raganingizda, farzandingiz o'z ruchkasini ko'rsatishi kifoya.

Shu o'rinda jadvallar hamda rasmlar yonida berilgan inglizcha gap, so'z va iboralarning transkripsiyasini o'qishdan oldin quyida keltirilgan qoidalar, fonetik ma'lumotlar bilan yaxshilab tanishib chiqishingiz, ingliz tiliga xos ayrim tovushlarni (ayniqsa, [θ], [ð], [v], [w], [i:], [ɔ:], [ɑ:], [u:], [ɜ:], [æ], [eə], [ʊə]) talaffuz qilishda qiyinchilik sezsangiz, ular haqida o'qituvchidan yordam so'rashingiz maqsadga muvofiqdir.

Ingliz tilining unli hamda undosh tovushlari

Ingliz tili alifbosi 26 harfdan iborat bo'lib, ulardan 20 tasi undosh (b, c, d, f, g, h, j, k, l, m, n, p, q, r, s, t, v, w, x, z), 6 tasi esa unli (a, e, i, o, u, y) harflar hisoblanadi. Bu unli va undosh harflar jami bo'lib 44 ta (24 ta undosh va 20 ta unli) tovush beradi.

Bu tovushlarni quyidagi qiyosiy jadvallar orqali o'zbek tilida mavjud tovushlar bilan taqqoslab, osongina o'rganib olishingiz va mazkur kitobdagi inglizcha so'zlarning transkripsiyasini o'qiy olish hamda inglizcha talaffuzni to'g'ri amalga oshirish imkoniyatiga ega bo'lishingiz mumkin.

So'zlarning transkripsiyasi o'rta [] qavslar ichida berilgan. Transkripsiyada asosiy urg'u ['] (masalan: cabbage ['kæbɪdʒ]), ikkilamchi, ya'ni kuchsizroq urg'u esa [,] belgisi bilan ifodalangan (masalan: engineer [ˌendʒɪnɪr]).

Ingliz va o'zbek tillari undosh tovushlarining qiyosiy jadvali

Ingliz tili undosh tovushlari	O'zbek tilidagi o'xshash tovushlar	Ingliz tili undosh tovushlari	O'zbek tilidagi o'xshash tovushlar
[p] p lum [plʌm]	p arda	[s] s un [sʌn]	s alom
[b] b ath [bɑ:θ]	b ahor	[z] z oo [zu:]	z ar
[t] t ell [tel]	t ol	[ʃ] sh ip [ʃɪp]	sh amol
[d] d rop [drɒp]	d araxt	[ʒ] treas ure [ˈtreɜə]	j urnal
[k] k ing [kɪŋ]	k itob	[h] h ot [hɒt]	h akam
[g] g et [get]	g ul	[m] m y [maɪ]	m asal
[tʃ] ch ip [tʃɪp]	ch inor	[n] n ew [nju:]	n arvon
[dʒ] j ump [dʒʌmp]	j anub	[ŋ] sing [sɪŋ]	zang
[f] f un [fʌn]	f asl	[l] lake [leɪk]	l ola
[v] v ase [vɑ:z]	v araq	[r] role [rəʊl]	r asm*** ³
[θ] th ink [θɪŋk]	*** ¹	[j] year [jɪə]	y o'l
[ð] th at [ðæt]	*** ²	[w] w ing [wɪŋ]	quv at*** ⁴

*****Izoh:**

1) Ingliz tilida "th" harflar birikmasi ba'zan [θ] tovushi, ba'zan esa [ð] tovushini beradi. [θ] tovushi o'zbek tilidagi "s" tovushiga o'xshasa-da, u biroz boshqacharoq talaffuz etiladi. U tish oralig'i tovushi hisoblanadi. Demak, [θ] tovushini talaffuz qilish uchun til uchi tishlar orasiga keltirilib, havo jarangsiz chiqariladi. [θ] tovushini qoidaga binoan to'g'ri talaffuz etish va uni o'zbek tilidagi "s" tovushidek talaffuz etmaslik lozim. Aks holda, butunlay boshqacha ma'noga ega so'z anglashilishi mumkin. Taqqoslang: **think** (o'ylamoq) — **sink** (cho'kmoq); **thin** (yupqa, ingichka) — **sin** (gunoh);

2) [ð] tovushi esa o'zbek tilidagi "z" tovushiga o'xshasa-da, undan biroz farq qiladi. U ham tish oralig'i tovushi hisoblanadi. Shuning uchun [ð] tovushini talaffuz qilishda til uchi tish oralig'iga keltiriladi va havo jarangli qilib chiqariladi;

3) Ingliz tilidagi [r] tovushi o'zbek tilidagi "r" titroq tovushidan o'zgacha talaffuz etiladi. Ingliz tilidagi [r] tovushi tanglay yumshoq tovushi hisoblanadi, ya'ni u til uchini tanglayga ko'tarib, uni titratmasdan talaffuz etiladi;

4) Ingliz tilidagi [w] tovushi ham o'zbek tilidagi "v" tovushidan o'zgacha talaffuz etiladi. Inglizcha [w] tovushi o'zbekcha "v" tovushidan farqli o'laroq, lablanmagan. U lablarni cho'zib, aylana hosil qilish orqali talaffuz qilinadi. [w] tovushini qoidaga binoan to'g'ri talaffuz etish va uni o'zbek tilidagi "v" tovushidek talaffuz etmaslik lozim. Aks holda, butunlay boshqacha ma'noga ega so'z talaffuz etilgan bo'ladi. Taqqoslang: **west** (g'arb) — **vest** (mayka; nimcha).

Ingliz va o'zbek tillari unli tovushlarining qiyosiy jadvali

Ingliz tili unli tovushlari	O'zbek tilidagi o'xshash tovushlar	Ingliz tili unli tovushlari	O'zbek tilidagi o'xshash tovushlar
[i:] each [i:tʃ]	*** ¹	[ɜ:] learn [lɜ:n]	*** ¹
[ɪ] its [ɪts]	igna	[ə] river ['rɪvə]	olti
[e] leg [leg]	ellik	[eɪ] say [seɪ]	ey! (<i>chaqiriq</i>)
[æ] bag [bæg]	*** ^{2a}	[əʊ] go [gəʊ]	teleshou
[ɑ:] car [kɑ:]	*** ¹	[aɪ] fine [faɪ]	nay
[ɒ] top [tɒp]	qop	[aʊ] cloud [klaʊd]	pauza
[ɔ:] forty ['fɔ:ti]	*** ¹	[ɔɪ] coin [kɔɪn]	loy
[ʊ] good [gʊd]	kun	[ɪə] here [hɪə]	iy! (<i>ajablanish</i>)
[u:] rule [ru:l]	*** ¹	[eə] chair [tʃeə]	*** ^{2b}
[ʌ] cut [kʌt]	qand	[ʊə] usual ['ju:ʒʊəl]	*** ^{2d}

*****Izoh:**

1) Ingliz tilida cho'ziq tovushlar [:] transkripsiya belgisi bilan ifodalanadi. O'zbek tilida [i:], [ɔ:], [ɑ:], [u:] va [ɜ:] kabi cho'ziq tovushlar mavjud emas. Biroq quyidagi tovushlar cho'zib o'qilsa, ularning talaffuzini o'xshatish mumkin: **nina** [ɪ] — **niina** [i:]; **sholg'om** [ɒ] — **sholg'oom** [ɔ:]; **fan** [ʌ] — **faan** [ɑ:]; **bu** [ʊ] — **buu** [u:]; **olti** [ə] — **oltiin** [ɜ:];

2) o'zbek tilida [æ], [eə] va [ʊə] kabi tovushlar ham mavjud emas. Shuning uchun ularni talaffuz qilish o'zbek o'quvchilari uchun biroz qiyinchilik tug'dirishi tabiiy. Bu tovushlarga quyidagicha ta'rif berish mumkin:

a) [æ] tovushi [a] va [e] tovushlari uyg'unligidan tashkil topadi. U o'zbek tilidagi "e" tovushiga o'xshash, lekin [æ] tovushini talaffuz qilish uchun og'iz "e" ning talaffuziga qaraganda kattaroq ochiladi;

b) [eə] tovushi [e] va [ə] tovushlari uyg'unligidan tashkil topadi. [eə] tovushini talaffuz qilish uchun talaffuz [e] tovushidan boshlanib, [ə] tovushi bilan yakunlanishi kerak;

d) [ʊə] tovushi [ʊ] va [ə] tovushlari uyg'unligidan tashkil topadi. [ʊə] tovushini talaffuz qilish uchun talaffuz [ʊ] tovushidan boshlanib, [ə] tovushi bilan yakunlanishi lozim.

Unit 1 Greetings

Questions (Savollar)	Answers (Javoblar)
What's your name? [ˈwɒts jɔː neɪm] Sizning ismingiz nima?	My name is Jasur. [maɪ 'neɪm ɪz dʒɑː'sʊr] Mening ismim Jasur.
How are you? [haʊ 'ɑː juː] Ahvotingiz qanday?	Great./OK. [ɡreɪt/əʊ'keɪ] Zo'r./Hammasi joyida.
Where are you from? [ˈweərəː juː frɒm] Siz qayerdانسiz?	I'm from Samarkand. [aɪm frɒm sɑːmɑːr'kɑːnd] Men Samarqanddanman.

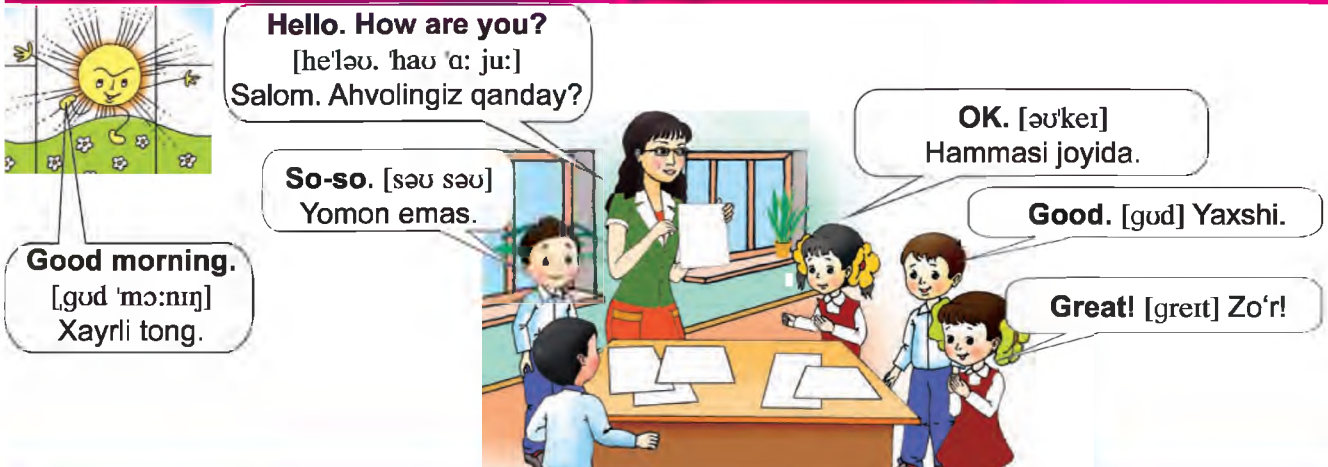

Unit 2 I'm in class 1.

Questions (Savollar)	Answers (Javoblar)
How old are you? [haʊ əʊld 'ɑː juː] Yoshingiz nechada?	I'm 7. [aɪm 'sevn] Men 7 yoshdaman.
Is it a pen? [ɪz ɪt ə 'pen] Bu ruchkami?	Yes./No. [jes / nəʊ] Ha./Yo'q.
What's this? [ˈwɒts ðɪs] Bu nima?	It's a pen. [ɪts ə 'pen] Bu ruchka.
Where is the pen? (Show.)* [weəz ðə 'pen] Ruchka qayerda? (Ko'rsating.)	(Pupil shows or points.)* (O'quvchi barmog'i bilan ko'rsatadi.)

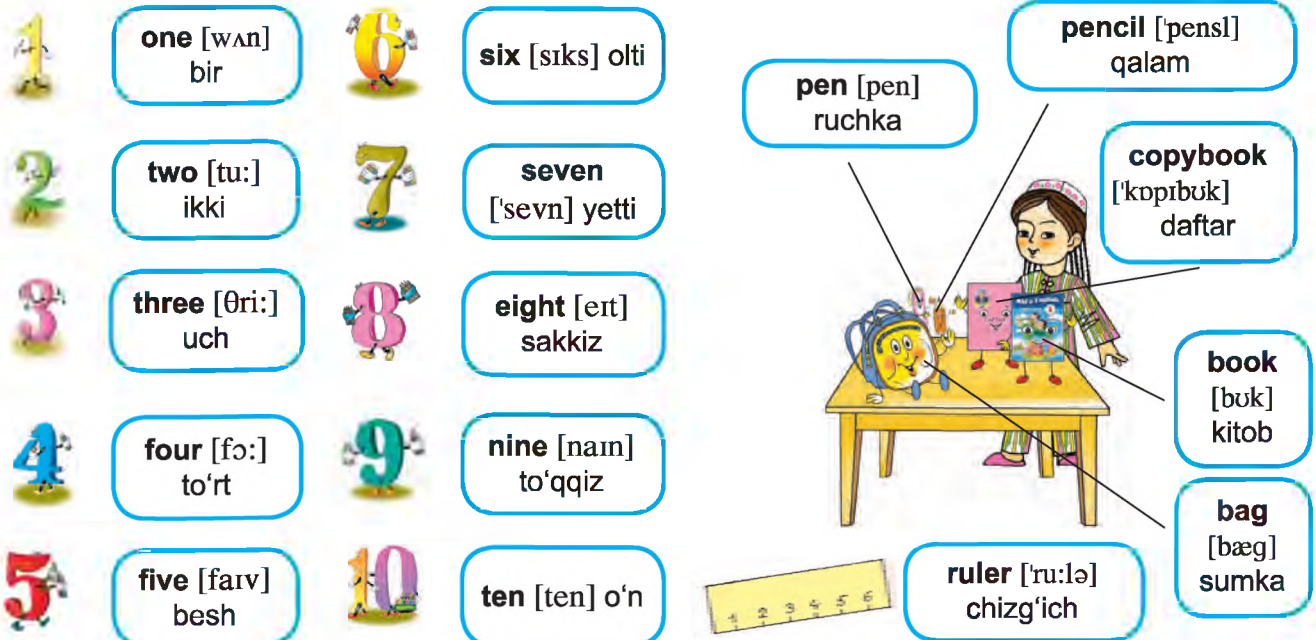

Unit 3 My family

Questions (Savollar)	Answers (Javoblar)
Who is this? ['hu: ɪz ðɪs] Bu kim?	This is my mother. ['ðɪs ɪz maɪ 'mʌðə] Bu mening onam.
What's his name? ['wɒts hɪz 'neɪm] Uning ismi nima?	His name's Rustam. [hɪz 'neɪmz rʊs'tʌm] Uning ismi Rustam.
What's her name? ['wɒts hɜ: 'neɪm] Uning ismi nima?	Her name's Sevara. [hɜ: 'neɪmz sevə'rʌ] Uning ismi Sevara.

family ['fæməli] oila

father ['fɑ:ðə] ota

mother ['mʌðə] ona



baby ['beɪbi]
go'dak / chaqaloq

sister ['sɪstə] opa / singil

brother ['brʌðə] aka / uka

Unit 4 My friend

Questions (Savollar)	Answers (Javoblar)
Who is your friend?* ['hu: ɪz jʊ: 'frend] Sizning do'stingiz kim?	Jasur. [dʒʌ'sʊr] Jasur.
How old is he?* ['həʊ əʊld ɪz hi:] Uning yoshi nechada?	He's 7.* [hi:z 'sevn] U 7 yoshda.
How old is she?* ['həʊ əʊld ɪz ʃi:] Uning yoshi nechada?	She's 6.* [ʃi:z 'sɪks] U 6 yoshda.

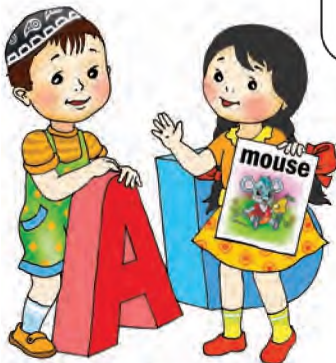

I'm a boy. [aɪm ə 'bɔɪ] Men o'g'il bolaman.
She's a girl. [ʃi:z ə 'gɜ:l] U qiz bola.

I'm a girl. [aɪm ə 'gɜ:l] Men qiz bolaman.
He's a boy. [hi:z ə 'bɔɪ] U o'g'il bola.



Unit 5 Toys and colours

Questions (Savollar)	Answers (Javoblar)
What's this? ['wɒts ðɪs] Bu nima?	It's a car. [ɪts ə 'kɑː] Bu avtomobil.
What colour is it? ['wɒt 'kɒlə ɪz ɪt] Uning rangi qanday?	It's blue. [ɪts 'bluː] U ko'k rangda.
Is it a doll? [ɪz ɪt ə 'dɒl] Bu qo'g'irchoqmi?	Yes./No. [jes / nəʊ] Ha./Yo'q.

toy [tɔɪ] o'yinchoq

plane [pleɪn] samolyot
ball [bɔːl] koptok
purple [pɜːpl] binafsharang
black [blæk] qora
brown [braʊn] jigarrang
blue [bluː] ko'k
teddy bear ['tedɪbeə] paxmoq ayiq
car [kɑː] avtomobil
doll [dɒl] qo'g'irchoq
pink [pɪŋk] pushti
white [waɪt] oq
orange ['ɒrɪndʒ] olovrang
grey [greɪ] kulrang
train [treɪn] poyezd

Unit 6 Parts of the body

Questions (Savollar)	Answers (Javoblar)
What's this? ['wɒts ðɪs] Bu nima?	It's a head. [ɪts ə 'hed] Bu bosh.
Is this a head? [ɪz ðɪs ə 'hed] Bu boshmi?	Yes. (Yes, it is.)/No. (No, it isn't.) [jes. ('jes ɪt 'ɪz) / nəʊ. ('nəʊ ɪt 'ɪznt)] Ha (bu bosh)./Yo'q (bu bosh emas).
What can fly?* ['wɒt kæn 'flaɪ] Nima ucha oladi?	A kite.* [ə 'kaɪt] Varrak.
Who can swim?* ['huː kæn 'swɪm] Kim suza oladi?	Jasur.* [dʒɜː'sʊr] Jasur.

fly [flaɪ] uchmoq
run [rʌn] yugurmoq
jump [dʒʌmp] sakramoq
climb [klaɪm] tirmashib chiqmoq
swim [swɪm] suzmoq
go [gəʊ] yurmoq
nose [nəʊz] burun
head [hed] bosh
eye [aɪ] ko'z
mouth [maʊθ] og'iz
right [raɪt] o'ng
hand [hænd] qo'l
left [left] chap
leg [leg] oyoq

Unit 7 Seasons

Questions (Savollar)	Answers (Javoblar)
Is it summer? [ɪz ɪt 'sʌmə] Yoz faslimi?	Yes. (Yes, it is.)/No. (No, it isn't.) [jes. ('jes ɪt 'ɪz) / nəʊ. ('nəʊ ɪt 'ɪznt)] Ha (yoz fasli)/Yo'q (yoz fasli emas).
Why do you like spring?* ['waɪ du: ju: 'laɪk 'sprɪŋ] Nima uchun siz bahorni yoqtirasiz?	It's warm.* [ɪts 'wɔ:m] Chunki havo iliq bo'ladi.
What colour is winter? ['wɒt 'kʌləz ɪz 'wɪntə] Qishning rangi qanaqa?	White. [waɪt] Oq (rang).
Is it hot? [ɪz ɪt 'hɒt] Havo issiqmi?	Yes. (Yes, it is.)/No. (No, it isn't.) [jes. ('jes ɪt 'ɪz) / nəʊ. ('nəʊ ɪt 'ɪznt)] Ha (issiq)/Yo'q (issiq emas).



cold
[kəʊld] sovuq

warm
[wɔ:m] iliq

hot
[hɒt] issiq

cool
[ku:l] salqin

stand up ['stænd 'ʌp]
turmoq

sit down ['sɪt 'daʊn]
o'tirmoq

New Year [nju: 'jɪə]
Yangi yil

New Year tree [nju: 'jɪə 'tri:]
Yangi yil archasi

snowman ['snəʊmən]
qorbobo

Father Frost [fɑ:ðə 'frɒst]
Qorbobo

winter
['wɪntə] qish

spring
['sprɪŋ] bahor



autumn
[ɔ:təm] kuz

summer
['sʌmə] yoz

Unit 8 The world around us

Questions (Savollar)	Answers (Javoblar)
What's the weather? ['wɒts ðə 'weðə] Ob-havo qanday?	It's sunny. [ɪts 'sʌni] Havo ochiq.
Can you skate?* [kən ju: 'sketɪ] Siz konkida ucha olasizmi?	Yes./No.* [jes / nəʊ] Ha./Yo'q.
Is it sunny? [ɪz ɪt 'sʌni] Quyoshli kunmi?	Yes. (Yes, it is.)/No. (No, it isn't.) [jes. ('jes ɪt 'ɪz) / nəʊ. ('nəʊ ɪt 'ɪznt)] Ha (quyoshli)/Yo'q (quyoshli emas).



cloudy
['klaʊdi]
bulutli



rainy
['reɪni]
yomg'irli

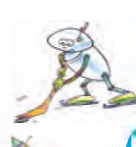

hockey
['hɒki]
xokkey

fly a kite ['flaɪ ə 'kaɪt]
varrak uchirmoq



snowy
['snəʊi]
qorli



sunny
['sʌni]
quyoshli



ski [ski:]
chang'ida
uchmoq

skate [sketɪ]
konkida uchmoq



football ['fʊtbɔ:l] futbol

jump a rope
[dʒʌmp ə 'rəʊp]
arqonda sakramoq

Unit 9 Domestic animals

Questions (Savollar)	Answers (Javoblar)
What's this? ['wɒts ðɪs] Bu nima?	It's a rabbit. [ɪts ə 'ræbɪt] Bu quyon.
What colour is the sheep? ['wɒt 'kʌləɪz ðə 'ʃi:p] Qo'yingning rangi qanaqa?	It's brown. [ɪts 'braʊn] U jigarrang.

domestic animals [də'mestɪk 'æniməlz] uy hayvonlari

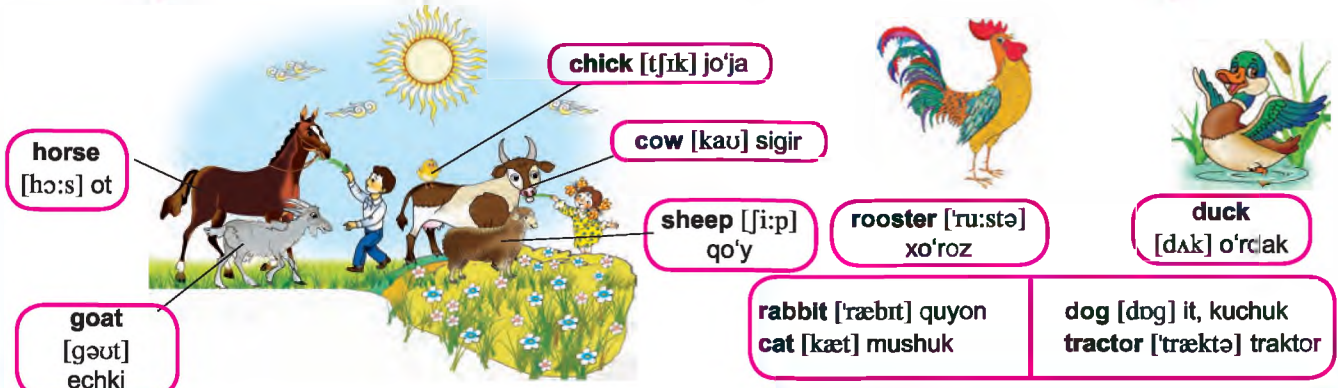

Unit 10 Wild animals

Questions (Savollar)	Answers (Javoblar)
What can you do?* ['wɒt kən ju: 'du:] Siz nima qila olasiz?	I can run.* [aɪ kən 'rʌn] Men yugura olaman.
Can you jump?* [kən ju: 'dʒʌmp] Siz sakrav olasizmi?	Yes./No.* [jes / nəʊ] Ha./Yo'q.
What colour is the crocodile?* ['wɒt 'kʌləɪz ðə 'krɒkədɑɪl] Timsohning rangi qanday?	It's green.* [ɪts 'grɪ:n] U yashil.

wild animals ['waɪld 'æniməlz] yovvoyi hayvonlar

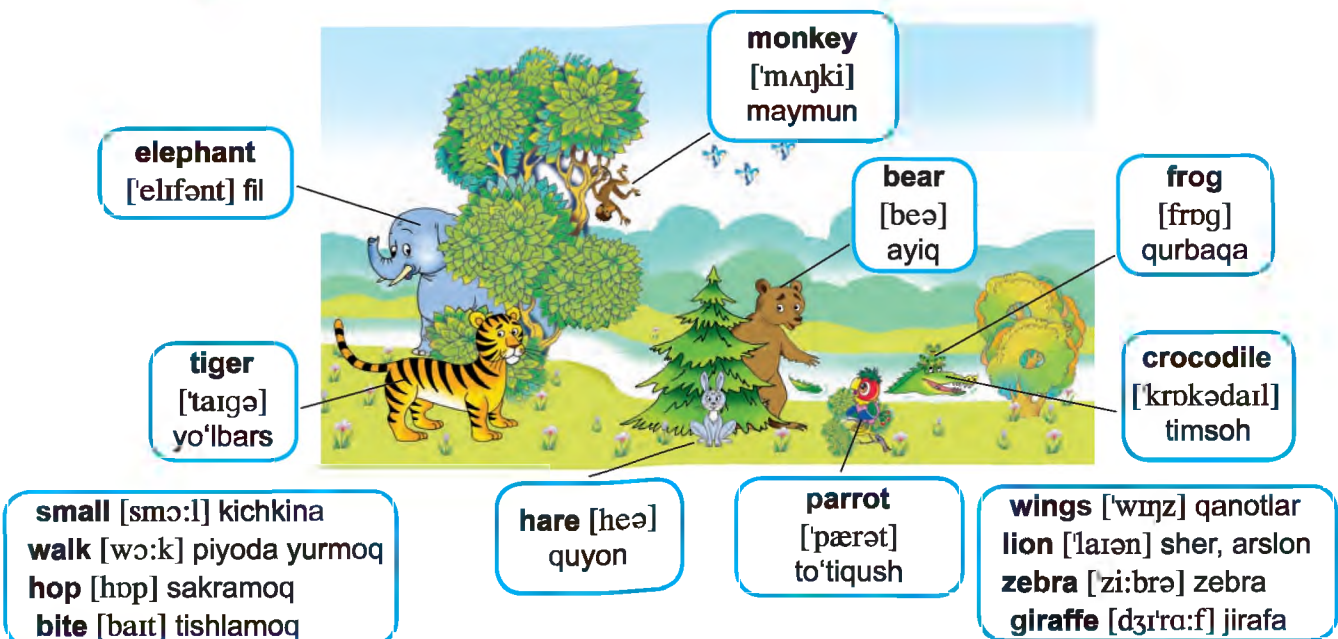

Unit 11 Vegetables

Questions (Savollar)	Answers (Javoblar)
Is it a cucumber? [ɪz ɪt ə 'kju:kəmbə] Bu bodringmi?	Yes. (Yes, it is.)/No. (No, it isn't.) [jes. ('jes ɪt 'ɪz) / nəʊ. ('nəʊ ɪt 'ɪznt)] Ha (bodring)/Yo'q (bodring emas).
What's this? ['wɒts ðɪs] Bu nima?	It's a carrot. [ɪts ə 'kærət] Bu sabzi.

vegetables ['vedʒtəbləz] sabzavotlar

potato [pə'teɪtəʊ] kartoshka

cabbage ['kæbɪdʒ] karam

tomato [tə'mɑ:təʊ] pomidor

carrot ['kærət] sabzi

eggplant ['egplɑ:nt] baqlajon

onion ['ʌnjən] piyoz

cucumber ['kju:kəmbə] bodring

pepper ['pepə] qalampir

pumpkin ['pʌmpkɪn] oshqovoq

11 eleven [ɪ'levn] o'n bir

12 twelve ['twelv] o'n ikki

20 twenty ['twenti] yigirma

30 thirty ['θɜ:ti] o'ttiz

40 forty ['fɔ:ti] qirg

50 fifty ['fɪfti] ellik

Unit 12 Fruit

Questions (Savollar)	Answers (Javoblar)
Is it fruit? [ɪz ɪt 'fru:t] Bu mevami?	Yes. (Yes, it is.)/No. (No, it isn't.) [jes. ('jes ɪt 'ɪz) / nəʊ. ('nəʊ ɪt 'ɪznt)] Ha (meva)/Yo'q (meva emas).
What's this? ['wɒts ðɪs] Bu nima?	It's a banana. [ɪts ə bə'nɑ:nə] Bu banan.

fruit [fru:t] mevalar

peach [pi:tʃ] shaftoli

apple [æpl] olma

grapes ['greɪps] uzum

strawberry ['strɔ:bəri] qulupnay

cherry ['tʃeri] olcha

banana [bə'nɑ:nə] banan

pear [peə] nok

orange ['ɒrɪndʒ] apelsin

apricot ['eɪprɪkɒt] o'rik

watermelon ['wɔ:təmelən] tarvuz

13 thirteen [θɜ:ti:n] o'n uch

14 fourteen [fɔ:ti:n] o'n to'rt

15 fifteen [fɪfti:n] o'n besh

16 sixteen [sɪks'ti:n] o'n olti

17 seventeen [sevnti:n] o'n yetti

18 eighteen [eɪti:n] o'n sakkiz

19 nineteen [naɪnti:n] o'n to'qqiz

20 twenty ['twenti] yigirma

Unit 13 Things we can do

Questions (Savollar)	Answers (Javoblar)
Can you draw? [kən ju: 'drɔ:] Siz rasm chiza olasizmi?	Yes./No. [jes / nəʊ] Ha./Yo'q.
Can you count? [kən ju: 'kaʊnt] Siz sanay olasizmi?	Yes./No. [jes / nəʊ] Ha./Yo'q.
Do you like spring? [du: ju: 'laɪk 'sprɪŋ] Siz bahorni yoqtirasizmi?	Yes. (Yes, I do.)/No. (No, I don't.) [jes. ('jes aɪ 'du:) / nəʊ. ('nəʊ aɪ 'dɒnt)] Ha (yoqtiraman)./Yo'q (yoqtirmayman).



rainbow ['reɪnbəʊ] kamalak

see [si:] ko'rmoq
draw [drɔ:] chizmoq
count [kaʊnt] sanamoq
like [laɪk] yoqtirmoq

flower ['flaʊə] gul

Unit 14 Fairy world

Questions (Savollar)	Answers (Javoblar)
Do you like fairy tales? [du: ju: 'laɪk 'feəri teɪlz] Siz ertaklarni yoqtirasizmi?	Yes. (Yes, I do.)/No. (No, I don't.) [jes. ('jes aɪ 'du:) / nəʊ. ('nəʊ aɪ 'dɒnt)] Ha (yoqtiraman)./Yo'q (yoqtirmayman).
Is she good? (bad) [ɪz ʃi: 'ɡʊd / bæd] U yaxshimi (yomonmi)?	Yes. (Yes, she is.)/No. (No, she is not.) [jes. ('jes ʃi: 'ɪz) / nəʊ. ('nəʊ ʃi: 'ɪznt)] Ha (ha, yaxshi (yomon.)/Yo'q (yo'q, yaxshi emas (yomon).
Is it big? [ɪz ɪt 'bɪɡ] U kattami?	Yes. (Yes, it is.)/No. (No, it is not.) [jes. ('jes ɪt 'ɪz) / nəʊ. ('nəʊ ɪt 'ɪznt)] Ha (ha, katta.)/Yo'q (yo'q, katta emas).



magic wand
[ˌmædʒɪk 'wɒnd]
sehrlı tayoqcha

magic lamp
[ˌmædʒɪk 'læmp]
sehrlı chiroq



good [ɡʊd] yaxshi
bad [bæd] yomon
big [bɪɡ] katta

short [ʃɔ:t] kalta
long [lɒŋ] uzun
tail [teɪl] dum