

TASVIRIY SAN'AT

*Umumiy o'rta ta'lim maktablarining
2-sinfi uchun darslik*

Qayta ishlangan va to'ldirilgan
beshinchi nashri

*O'zbekiston Respublikasi Xalq ta'limi
vazirligi tasdiqlagan*



**Cho'lpon nomidagi nashriyot-matbaa ijodiy uyi
Toshkent — 2018**

UO'K 372.874(075)
KBK 85.15ya71
T 25

Mualliflar:

**M. Isoqova, R. Hasanov, B. Haydarov,
A. Sulaymanov, S. Jumaniyazova, A. Roziqov**

Taqrizchilar:

- R. Xudayberganov* – O‘zbekiston xalq rassomi, K. Behzod nomidagi Milliy rassomlik va dizayn instituti professori;
G. Zulxaydarova – Respublika ta‘lim markazi metodisti;
N. Xaytanova – Toshkent shahar, Mirzo Ulug‘bek tumani 187-maktab o‘qituvchisi;
B. Yunusova – Toshkent shahar, Yunusobod tumani 43-maktab o‘qituvchisi

SHARTLI BELGILAR:



– faollashtiruvchi savollar



– o‘rganish va yodda tutish zarur



– amaliy mashq va topshiriqlar



– uyga berilgan topshiriqlar



– qiziqarli topshiriqlar



– iqtidorli bolalar uchun topshiriqlar



– takrorlash uchun savollar



– dars tugadi

Respublika maqsadli kitob jamg‘armasi mablag‘lari hisobidan chop etildi

ISBN 978-9943-05-820-0

© M. Isoqova va boshq., 2018
© Cho‘lpon nomidagi NMIU, 2016
© Cho‘lpon nomidagi NMIU, 2018

I CHORAK



P. Toxirov. *Oltin kuz*

Bu chorakda siz:

- qora qalam, mo'yqalam va bo'yoqlar bilan ishlashni davom ettirasiz;
- asosiy ranglardan hosila ranglarni hosil qilishga oid malakangizni rivojlantirasiz;
- tabiat manzaralari rasmini ishlaysiz;
- amaliy san'at haqida tushunchaga ega bo'lasiz;
- rassomlar tomonidan ishlangan natyurmortlarni idrok qilishni o'rganasiz.

1-SENTABR – O‘ZBEKISTON MUSTAQILLIGI KUNI



«Ezgulik arkasi» – Mustaqillik maydo-
nidagi haykaltaroshlik kompozitsiyasi.

RANG VA TUSLAR

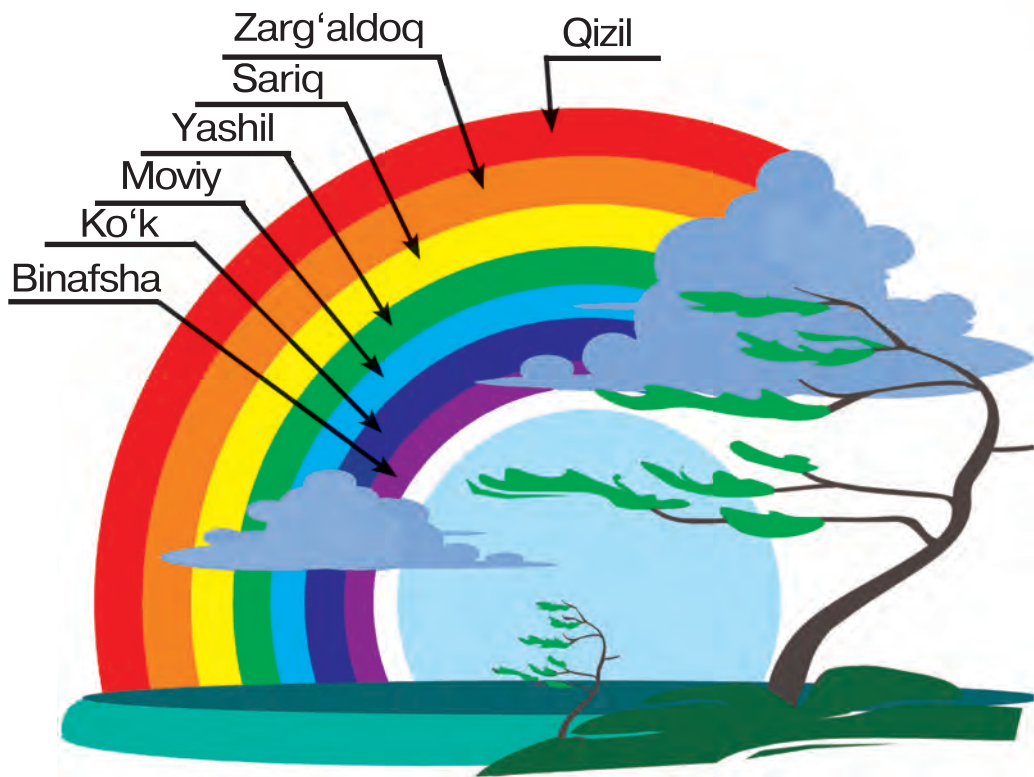

1. Kamalak osmonda qachon paydo bo'ladi?
2. Kamalak qanday ranglardan iborat?

Olam ranglarga boy. Ammo tabiatda uchta asosiy ranglar bo'lib, bular sariq, qizil va ko'kdir. Qolgan ranglar ana shu ranglarni bir-biriga qo'shish natijasida hosil qilinadi.





Asosiy ranglar.



Sariq.



Qizil.



Ko'k.

Asosiy ranglarning tushlari.

Bo'yoqqa ko'proq suv qo'shilsa och ranglar – **rang tushlari** hosil bo'ladi.

Sariq



Och sariq ranglar



Qizil



Och qizil ranglar



Ko'k



Och ko'k ranglar



Chizilgan rasmni bo'yashda akvarel bo'yoqlari ishlatiladi.









Akvarel – suvda eriydigan bo'yoq.





Ranglarning ramziy ma'nosi:

Tasviriy san'atda ranglarning ramziy ma'no-laridan ham foydalaniladi:

-  – ona tabiat ramzi;
-  – osmon, koinot, tinchlik ramzi;
-  – g'alaba, olov, shodlik ramzi;
-  – muqaddaslik, yorug'lik, quyosh ramzi;
-  – motam, qo'rquv, tushkunlik ramzi;
-  – poklik, ozodlik, baxt ramzi.

Mo'yqalamni ushlash.



Katta yuza
bo'alganda.



Ingichka, tor joylar
bo'alganda.



Qaysi rangni yoqtirasiz? Nega? Izohlab bering.





Rasm ishlashning asosiy bosqichlari.

1-bosqich. Tasvirni qog'ozga joylashtirish va o'lchamlarini belgilash.

Tasvirlanayotgan narsaning bo'yi va eni taq-qoslanib, tasvir qog'ozga bo'ylama yoki ko'n-dalang joylashtirilishi aniqlanadi. Narsaning o'rni, shakli, bo'yi, eni va o'zaro nisbatlari aniqla-nadi. Tasvir qog'ozning o'rtasiga chiziladi.



2-bosqich. Qalamda xomaki ishlash.

Narsaning tuzilishi, qismlari joylashuvi aniqlanadi va yordamchi chiziqlar bilan chiziladi.



3-bosqich. Tasvirni qalamda yakunlash.

Tasvirlanayotgan narsaning mayda bo'laklari qalamda ishlanadi. Yordamchi chiziqlar o'chirib tashlanadi.

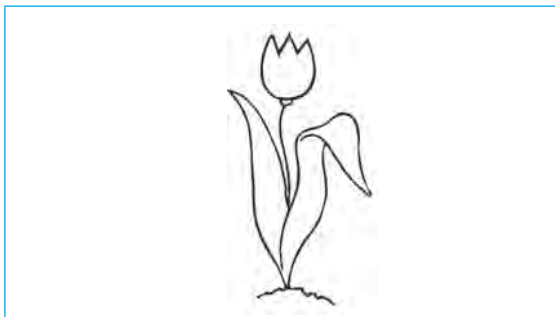

4-bosqich. Bo'yoqlar bilan ishlash.

Rasmga oldin och, so'ng to'qroq bo'yoqlar beriladi. Oxirida rasm bo'laklariga aniqlik kiritilib bo'yaladi.

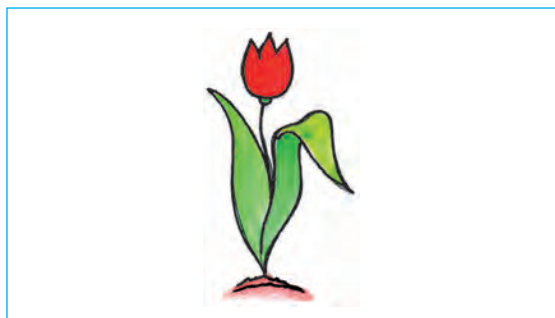

Rasm ishlayotganingizda yuqoridagi ko'rsatmalarga rioya qiling.



Tasvirning qog'ozdagi o'rnini qanday aniqlanadi?



MEVALAR RASMINI ISHLASH



G'.Abdurahmonov. *Kuz ne'matlari*

Rassom G'ofur Abdurahmonovning natyurmortida kuzgi mevalardan olma, nok, olxo'ri, poliz ekinlaridan tarvuz va qovun tasvirlangan. Ularning shakli va ranglarini diqqat bilan kuzating. Siz ham chizayotgan rasmingizda shunday ranglardan foydalanishga harakat qiling.





Natyurmort — «jonsiz tabiat» tasviridir. Unda uy-ro'zg'or buyumlari, mevalar, sabzavotlar, gullar kabi narsalar tasvirlanadi.



A. Bakirov. *Anorlar*



Yu. Elizarov. *Qovunlar*

Meva va buyumlar rasmlarini alohida-alohida ishlash bosqichlari.



Olma rasmini ishlash bosqichlari.

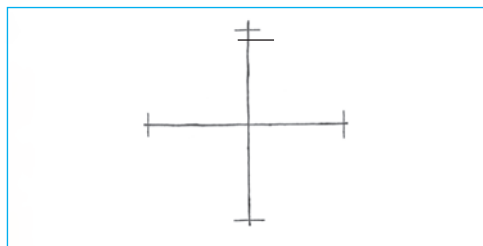

Tasvirni qog'ozga joylashtirish.



Tasvirni xomaki ishlash.

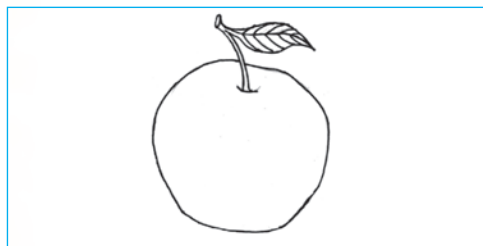

Tasvirni qalamda yakunlash, yordamchi chiziqlarni o'chirish.

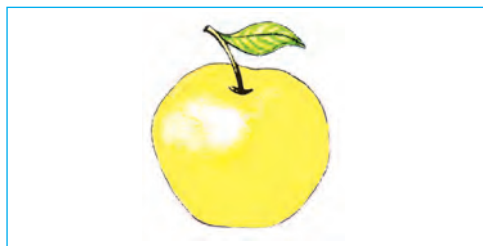

Och ranglarda bo'yash.



To'qroq ranglarda bo'yash.



Rasmga rang bilan yakuniy ishlov berish.





A. Ikromjonov. *Uzum va noklar*

Kuz ne'matlari tasvirlangan natyurmort ishlash ko'plab rassomlarning sevimli mavzusi. Rassom A. Ikromjonov ham kuzgi mevalarni mahorat bilan tasvirlagan.

Asarda nok, olma, uzum kabi mevalarning ranglari mahorat bilan chizilgan. Ular xuddi yoningda turgandek taassurot uyg'otadi.



Olma, tarvuz va ko'zadan tashkil topgan natyurmort rasmini islang.



Jonsiz narsalar tasvirlangan rasm qanday ataladi?



Mevalar va milliy idishdan tashkil topgan natyurmort soddaligi bilan rasm chizishda qiyinchilik tug'dirmaydi. Rasm ishlayotganingizda bu natyurmortdan ham foydalanishingiz mumkin.



1. Sinfda chizilgan natyurmortni akvarel bo'yoqlari bilan bo'yang.
- 2*. Mevalar va milliy idishdan tashkil topgan natyurmort rasmini chizing.



MANZARA RASMINI ISHLASH



F. Abdurahmonov. *Kuzgi manzara*

Kimdir shaharda, kimdir qishloqda yashaydi. Har kimning o‘z tug‘ilib o‘sgan joyi o‘ziga azizdir. Shaharlar keng ko‘chalari, zamonaviy ko‘prik-lari, baland binolari bilan ajralib turadi.

Mustaqillik sharofati bilan ko'plab turarjoylar va keng ko'chalar bunyod etildi.



1. Rasmlarda nimalar aks ettirilgan?
2. Shahar va qishloqning bir-biridan qanday farqi bor?
3. O'z shahringiz (qishlog'ingiz) haqida gapirib bering.



Rasm ishlashning sodda qoidalari.

Yerda tik turgan narsaning qog'ozdagi tasviri ham tik bo'ladi.



Narsalar rasm chizuvchidan bir xil uzoqlikda turgan bo'lsa, ularning qog'ozdagi tasvirlari nisbati haqiqiy o'lchamlari nisbati kabi bo'ladi.



Noto'g'ri.



To'g'ri.

Bir xil narsalar rasm chizuvchidan turli uzoqlikda turgan bo'lsa, yaqindagisi qog'ozda kattaroq, uzoqdagisi kichikroq tasvirlanadi. Bu tasviriy san'atda perspektiva deyiladi.



Noto'g'ri.



To'g'ri.



Daraxtlar, o't-o'lanlar va gullar bilan qoplangan manzara rasmini ishlash bosqichlari.

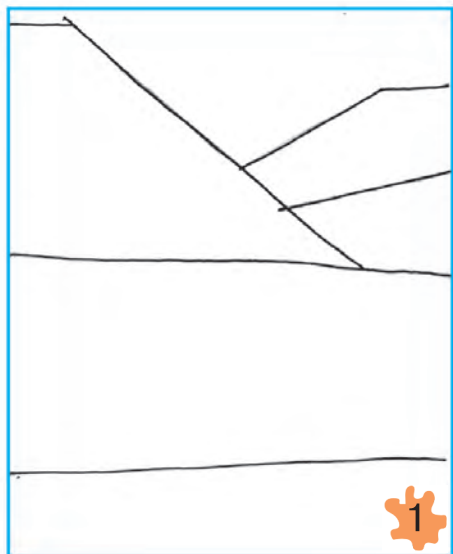

Quyidagi rasm va fotosuratga e'tibor bersangiz, uzoqdagi daraxtlar kichrayib ko'rinishining guvohi bo'lasiz.



O'zingiz yoqtirgan tabiat manzarasi rasmini ishlating. Rasmni ishlashda perspektivaga rioya qiling.



1. Perspektiva nima?
2. Narsa ko'zga yaqin yoki uzoq turganligiga qarab qanday tasvirlanadi?



1. Sinfda ishlangan manzara rasmini ishlashni davom ettiring va uni akvarelda bo'yang.
- 2*. «Shahrimiz (qishlog'imiz) ko'chalari» mavzusida mustaqil rasm ishlating.



USTOZLAR BAYRAMIGA TABRIKNOMA ESKIZINI ISHLASH



1-oktabr — O'qituvchi va murabbiylar kuni. Ustozlar bizlarga o'qish va yozishni o'rgatadilar. Kelajakda yaxshi inson bo'lib yetishishimizni ta'minlaydilar. Bu bayramda ularni tabriklashni unutmashimiz kerak.



1. Tabriknomalarda nimalarni aks ettirish mumkin?
2. Yana qanday tabriknomalarni bilasiz?



Tabriknoma eskizini ishlash bosqichlari.

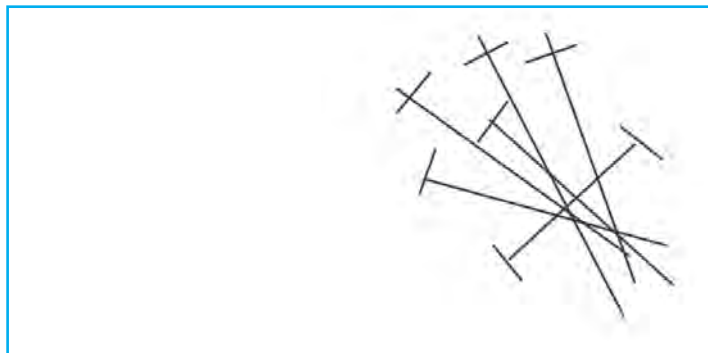

Tasvir o'lchamlarini belgilash.

Tasvirni xomaki ishlash.



Tasvirni qalamda yakunlash.



1-oktabr

Rasmni rang bilan yakunlash.



Namunalar asosida ustozlar kuniga bag'ishlangan «Bayramingiz muborak bo'lsin» tabriknomasining eskizini ishlang. Bu tabriknomaga ustozingizga atalgan iliq tilaklaringizni ham yozib qo'yishingiz mumkin. Faqatgina ular juda qisqa va samimiy bo'lishiga e'tibor qarating. Misol uchun: «Bayramingiz bilan», «Birinchi ustozimga ehtirom».



Sinfda ishlangan tabriknoma eskizini yakunlang.



«BO‘G‘IRSOQ» ERTAGI ASOSIDA HAYKAL YASASH



Bo‘g‘irsoq

(Ertak)

Men bo‘g‘irsoq, bo‘g‘irsoq,
Supradagi un-urvoq.
Supurishib oldilar
Qaymoqqa xo‘p qordilar.
Pishirdilar tovada,
Sovutdilar havoda.
Qochib ketdim bobomdan,
Qochib ketdim buvimdan.
Sendan esa quyonjon,
Qochib ketmoq
hech gapmas.





Bo'g'irsoqning yo'lida bo'ri va ayiq ham uchrabdi. Ulardan ham qo'shiq aytib qutulib qolibdi.

Biroq unga uchragan tulki ayyorlik qilibdi:

— Qulog'im yaxshi eshitmaydi. Qani tumshug'imga o'tirib, qo'shiq aytib ber-chi, — debdi.

Bo'g'irsoq tulkining tumshug'iga chiqib, endi kuylay boshlaganda, tulki uni hap etib, yeb qo'yibdi.





Berilgan rasmlardan foydalanib bo'g'irsoq ertagi qahramonlari haykalini yasang. Bunda ularning bir-biriga nisbatan katta-kichikligiga e'tibor qarating.



Bo'g'irsoq haykalchasini yasash bosqichlari.

1



Bo'g'irsoq haykalchasi qismlariga mos bo'laklar ajratib olinadi.

2



Bo'g'irsoq qismlariga shakl beriladi.

3



Bo'g'irsoq qismlari birlashtiriladi va yakuniy ishlov beriladi.



Tasvirlarni bir-biriga nisbatan ma'lum tartibda joylashtirish, birlashtirish **kompozitsiya** deb ataladi.



1. Berilgan rasmlar asosida sinfda yasalgan haykalchalardan iborat kompozitsiya tuzing.

2*. «Bo'g'irsoq» ertagi asosida rasm ishleng.



XALQ AMALIY SAN'ATI

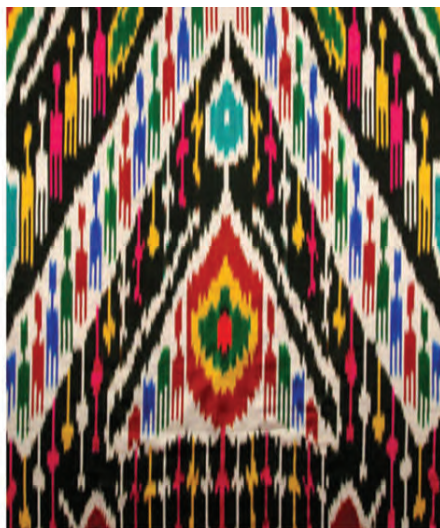



Xalq amaliy bezak san'ati turmushimizda eng ko'p qo'llaniladigan san'at turi hisoblanadi. Uning naqqoshlik, ganch o'ymakorligi, yog'och o'ymakorligi turlari mavjud. Shuningdek, badiiy hunarmandchilikning kulolchilik, zardo'zlik, kandakorlik, kashtachilik, gilamdo'zlik, do'ppido'zlik turlari insonlar turmushining go'zal bo'lishiga xizmat qiladi. Amaliy bezak san'ati Buxoro, Samarqand, Qo'qon, Marg'ilon kabi shaharlarda rivojlangan.



1. Rasmlarda nimalar tasvirlangan? Ular xalq amaliy san'atining qaysi turlariga mansub?
2. Ularni siz qayerlarda uchratgansiz?



Amaliy bezak san'ati turlari.



Zargarlik.

Zardo'zlik.



Kulolchilik.



Kashtachilik.



Kandakorlik.



Ganch o'ymakorligi.



Yog'och o'ymakorligi.



Rasmlarda keltirilgan amaliy bezak san'ati namunalarida ishlatilgan elementlar haqida hikoya tuzing.



Quyida tasvirlangan buyumlarning nomlarini ayting. Ularning shakli, bezaklarini hamda ulardan qanday maqsadlarda foydalanilishini sharhlab bering.



1. Amaliy bezak san'ati turi rivojlangan qaysi shaharlarni bilasiz?
2. Amaliy bezak san'ati turlarini sanab bering.
3. Siz yashaydigan joyda amaliy san'atning qaysi turi rivojlangan?



Amaliy san'at buyumlarini yasovchi hunarmandlar haqida kichik hikoya tuzing.



«KUZ KELDI» MAVZUSIDA RASM ISHLASH



R. Ahmedov. *Oqtoshda kuz*

O'lkamizda oltin kuz o'z sepini yoygan. Daraxt barglari sariq, zarg'aldoq va qizil ranglarda tovlanib, tabiat o'zgacha tarovat kasb etgan. Beixtiyor bu go'zal manzarani qog'ozda tasvirlagimiz keladi.

O'zbekistonlik rassomlar Nikolay Karaxan, O'rol Tansiqboyev, Rahim Ahmedov, Ne'mat Qo'ziboyev, Isfandiyor Haydarov, G'afur Abdurahmonov, Abduvali Mo'minovlar oltin kuz manzarasini o'ziga xos tarzda tasvirlaganlar.



1. Rasmda qaysi ranglar ko'proq ishlatilgan?
2. Kuzni nima sababdan oltinga qiyoslashadi?



Iliq ranglar:



— sariq;



— pushti;



— zarg'aldoq;



— qizil.



Iliq ranglar quyosh va olov ranglarini eslatadi. Kuz manzaralari ko'proq shu ranglarda tasvirlanadi.



Manzarali rasmlarda tabiat ko'ri-
nishlari aks ettiriladi.



Tabiat manzarasi rasmini ishlash bosqichlari.

1

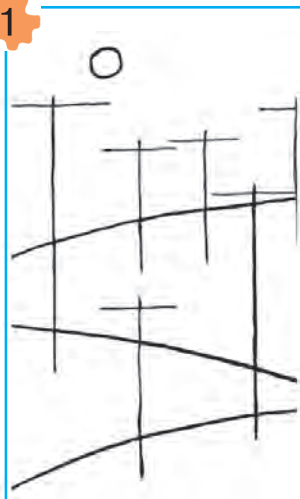

2

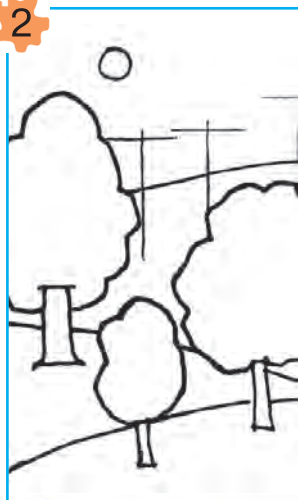

3



4



«Kuz keldi» mavzusida kichik hikoya tuzing va u asosida o'zingiz tasavvur etganday manzarali rasm islang.



**O'rol
Tansiqboyev**
(1904–1974)

O'zbekiston xalq rassomi O'. Tansiqboyev manzara janri ustasi sifatida dunyoga tanilgan. Mashhur asarlari: «Mening qo'shig'im», «Tog'da bahor», «Tog'da», «Angren vodiysi», «Baland tog' yaylovi» va boshqalar.



O'. Tansiqboyev. *Tog'da kuz*



1. Manzarali rasmlarda nimalar tasvirlanadi?
2. Tabiat manzaralari tasvirlangan yana qanday asarlarni bilasiz?



1. Sinfda ishlangan «Kuz keldi» mavzusidagi rasmni oxiriga yetkazing.
- 2*. Taassurotlaringiz asosida «Hosil bayrami» mavzusida rasm ishlang.





P. Toxirov. *Sanoat manzarasi*



ORALIQ NAZORAT DARSI

I. Test savollari:

1. Asosiy ranglar to'g'ri ko'rsatilgan bandni aniqlang:

A



B



D

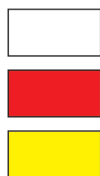

E



2. Qaysi rasmda tasvir to'g'ri joylashtirilgan?

A



B



D



E



3. Quyidagi rasmlarning qaysi birlari amaliy san'atga oidligini aniqlang.

A



B



D



E



4. Qaysi rasmda nisbat to'g'ri tasvirlangan?

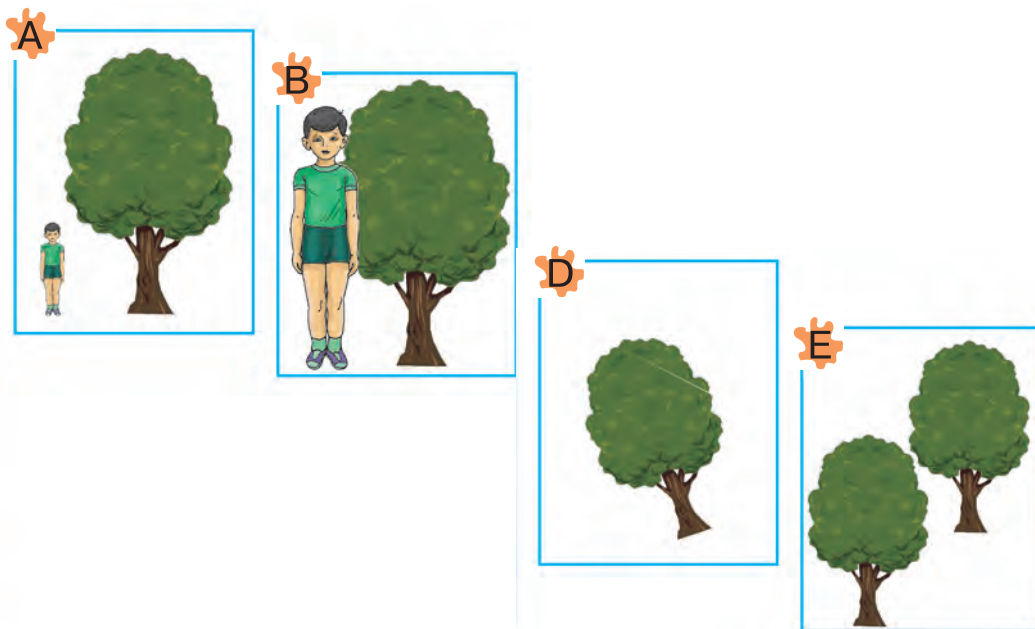

5. Iliq ranglar to'g'ri ko'rsatilgan bandni aniqlang:

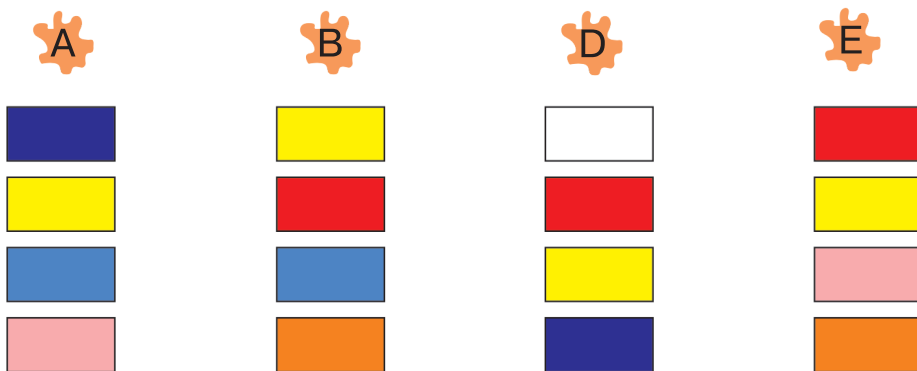

II. Amaliy topshiriq.

Manzara rasmini akvarelda bo'yab topshirish va u haqida qisqacha hikoya qilib berish.



II CHORAK



S. Sulaymonov. *Kuz*

Bu chorakda siz:

- yo'lsimon shaklidagi naqshlarni ishlashni;
- kuzgi ishlar mavzusida rasm ishlashni;
- ertaklar asosida haykalchalar ishlashni;
- ertak asosida rasm-illyustratsiya ishlashni o'rganasiz.

BALIQ HAYKALCHASINI YASASH

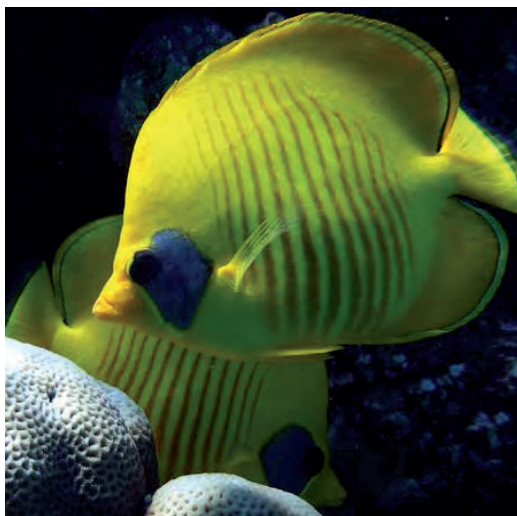

1. Baliqlar haqida nimalarni bilasiz?
2. Ularning turlari, shakllari va ranglari qanday bo'ladi?

O'zbekistonda baliqlarning 106 turi tarqalgan. Baliqlarning zog'ora baliq, laqqa baliq, cho'rtan, oqcha, oq amur, qizil ko'z, xumbosh, moybaliq kabi turlarini o'zingiz ham ko'rgan bo'lishingiz mumkin. Suvda tez suzadigan baliqlarning tanasi cho'ziq, sekin suzadiganlariniki yapaloqroq bo'ladi. Baliqlar bir-biridan katta kichikligiga qarab ham farqlanadi.



1. Baliqlar uchun suzgichlari qanday ahamiyatga ega?
2. Baliqlar quruqlikda yashay oladimi? Nima uchun?



O'zingiz istagan baliq haykalchasini yasang.



S. Redkin. *Baliq natyurmorti*



Baliq haykalchasini ishlash bosqichlari.

1



Baliq haykalchasi qismlariga mos bo'laklar ajratib olinadi.

2



Baliq qismlariga shakl beriladi.

3



Baliq qismlari birlashtiriladi.

4



Haykalchaga yakuniy ishlov beriladi.



1. Baliq turlaridan iborat bir nechta haykalchalar yasang.
- 2*. O'zingiz yoqtirgan baliq rasmini chizing.



«KUZGI ISHLAR» MAVZUSIDA RASM ISHLASH



P. Benkov. *Dugonalar*

KUZ

O'lkamizda kuz fasli. Bu faslda olma, uzum, behi, anor kabi ko'plab mevalar pishib yetiladi. Dalalarda paxtalar ochiladi. Ularni yig'ib-terib olish kuzgi ishlarni asosini tashkil qiladi.



«Kuzgi ishlar» mavzuzidagi rasmni ishlash bosqichlari.



Tasvirni qog'ozga joylashtirish.



Tasvirni aniqlashtirish.



Tasvirni qalamda yakunlash.



1. Kuzda yana qanday ishlar amalga oshiriladi?
2. «Mehrjon bayrami» haqida nimalarni bilasiz?



Tasvirni rang bilan yakunlash.



«Kuzgi ishlar» mavzusida ixtiyoriy rasm ishlang.



M. Saidov. *Uzum terimi*



1. Sinfda ishlangan «Kuzgi ishlar» mavzusidagi rasmni oxiriga yetkazing.

2*. Kuz mavzusida ixtiyoriy rasm chizing.



YO'LSIMON SHAKLIDA NAQSH ISHLASH



Naqshlarni har qadamda uchratish mumkin. Ular bilan bino va buyumlar bezatiladi. Naqshlar gullar, barglar, mevalar tasviri va boshqa shakllar asosida ishlanadi. Naqshlarning yo'lsimon, kvadrat, to'rtburchak va doiraviy shakllari bor.



1. Yuqorida keltirilgan rasmda binoning tashqi va ichki qismi nima bilan bezalgan?
2. Naqshlarni yana qayerlarda uchratish mumkin?



Naqshda ko'p uchraydigan bezak shakllari, ularning nomlanishi.

Naqqoshlikda qo'llaniladigan shakllar, asosan, tabiatdan olinadi. Shuning uchun ularning nomlanishi ham o'xshash bo'ladi. Quyidagi rasmlarni ko'rib, bunga ishonch hosil qilasiz.



barg



barg



uchbarg



qalampir



paxta



bofta



gajak



oygul



oygul



oygul



chinnigul



Yo'lsimon naqshlar.

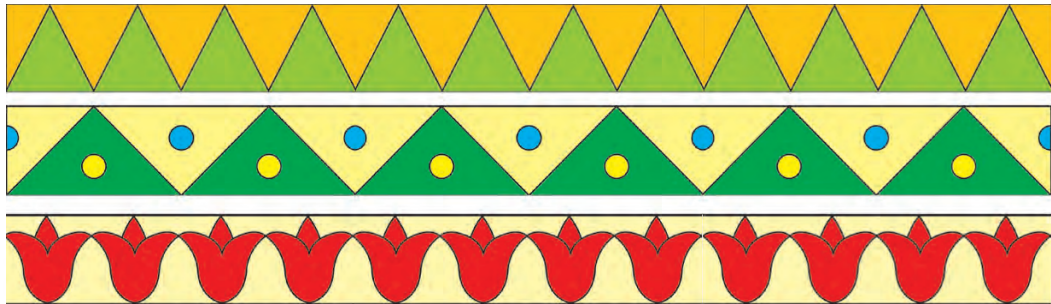

Yuqoridagi naqshlar yo'lsimon naqshlarga misol bo'la oladi. Ularning ko'rinishi uzun yo'lga o'xshaydi. Shu sababli ular yo'lsimon naqshlar deb ataladi.



Yo'lsimon naqsh ishlash bosqichlari.

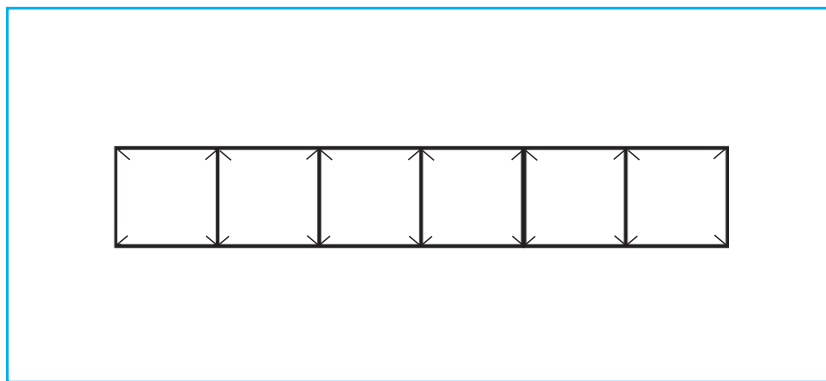

Qog'oz varag'i uchga bo'linadi, naqsh yo'li va kataklari belgilanadi.

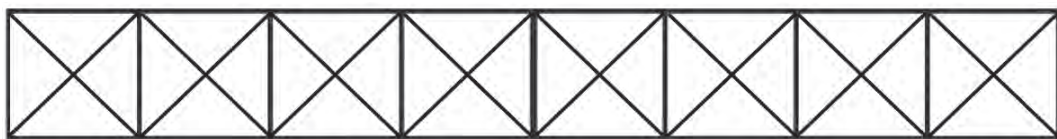

Asosiy naqsh elementini chizish.



Asosiy naqshni takror chizish.



Naqshni bo'yash bosqichlari.



1-bosqich.



2-bosqich.



3-bosqich.



1. Naqshlar nima maqsadda ishlanadi?
2. Tevarak-atrofdan yo'lsimon naqshga misol toping.



**Usta Shirin
Murodov**
(1879—1957)

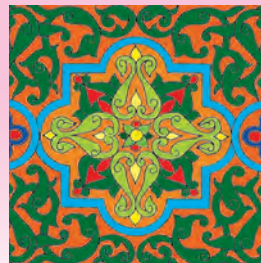

Usta Shirin Murodov — me'mor, ganch o'ymakori, O'zbekiston Fanlar akademiyasining faxriy a'zosi. O'zbekistonda xizmat ko'rsatgan san'at arbobi. Ganch o'ymakorligida yo'lsimon naqsh kompozitsiyalarini ko'p qo'llagan.

«Buyuk xizmatlari uchun» ordeni bilan mukofotlangan (2001-y.).



Namunaga qarab boshqacha tuzilishdagi yo'lsimon naqsh ishlang. Unda barglar, gullar tasvirlanishi mumkin.

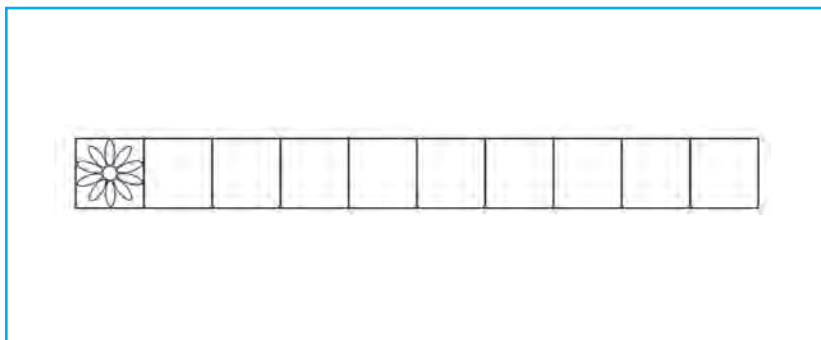

1. Sinfda ishlangan naqshni bo'yang.
- 2*. Biror buyumdagi yo'lsimon naqshdan nusxa oling.



«TULKI BILAN BO‘RI» ERTAGI ASOSIDA HAYKAL YASASH

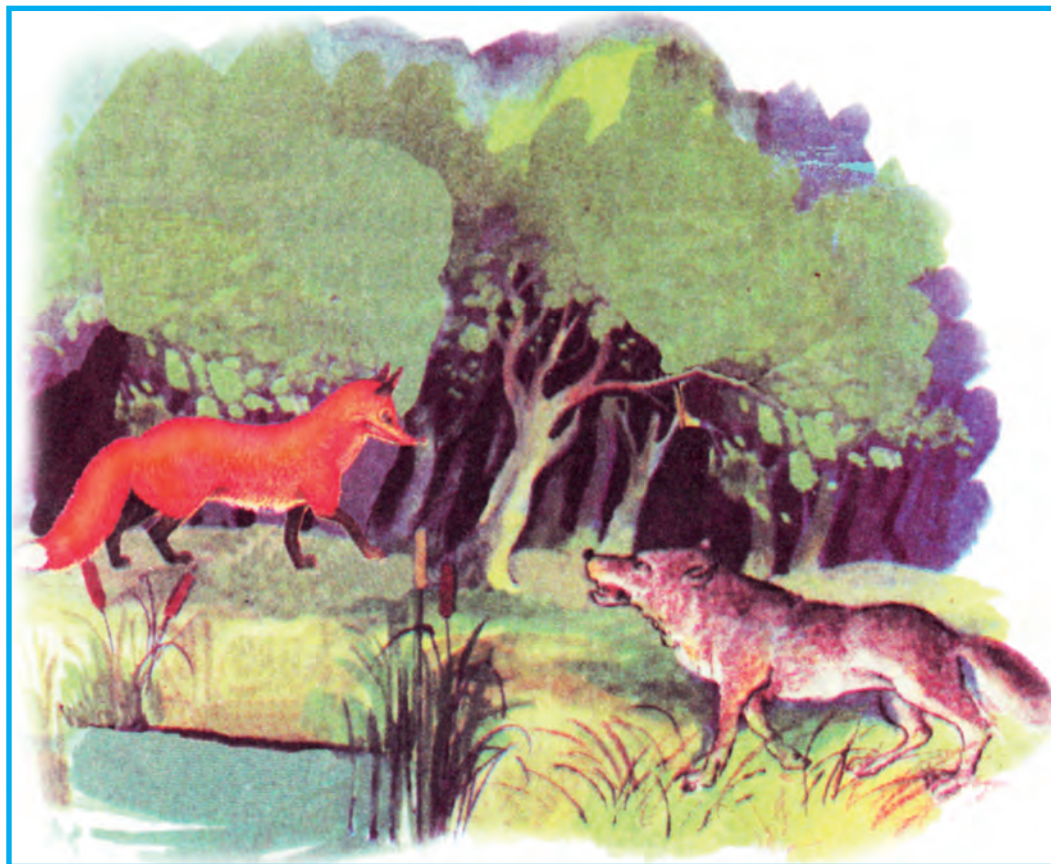

Tulki bilan bo‘ri

Tulki bilan bo‘ri qalin do‘st ekan... Tulki bo‘rini uzum o‘g‘rilikka olib boribdi. Tulki biroz uzum yegach, ikki dona uzumni burniga tiqib: «Men



shunday ko'p uzumni yedimki, hatto burnimdan chiqib ketayapti. Sen ham to'yib yegin, burningdan chiqadi», — debdi.

Bo'ri rosa ko'p uzum yesa ham burnidan chiqmabdi. Uning qorni shishib yiqilib qolibdi.

Tulki esa: «Uzumga o'g'ri keldi», — deb baqiribdi. Buni eshitgan bog'bon kelib bo'rini

tayoq bilan rosa savalabdi. Shu kundan boshlab bo'ri tulki bilan hech qayerga birga bormaydigan bo'libdi.



«Bo'ri bilan tulki» ertagi qahramonlari haykalchalarini yasang.



Tulki haykalchasini yasash bosqichlari.

1



Tulki haykalchasi qismlariga mos bo'laklar ajratib olinadi.

2



Tulki qismlariga shakl berilib, birlashtiriladi.

3



Tulkinging mayda qismlari birlashtiriladi.

4



Haykalchaga yakuniy ishlov beriladi.



Bo'ri haykalchasini yasash bosqichlari.

1



Bo'ri haykalchasi qismlariga mos bo'laklar ajratib olinadi.

2

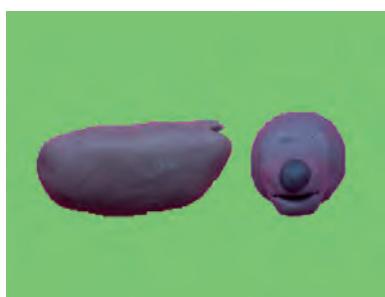

Bo'ri qismlariga shakl beriladi.

3



Bo'ri qismlari birlashtiriladi.

4



Haykalchaga yakuniy ishlov beriladi.



1. Berilgan namunalarga qarab tulki va bo'ri haykalchalarini yasang.
2. Tayyor haykalchalardan ertak mazmuniga moslab kompozitsiya tuzing.
- 3*. Ertakning boshqa voqeasi asosida kompozitsiya ishlang.



«ARCHA BAYRAMI» MAVZUSIDA RASM ISHLASH

Yangi yil dunyoning ko'pgina mamlakatlarida zo'r shodiyona bilan kutib olinadi. Bezatilgan archa, Qorbobo va Qorqiz Yangi yil bayrami ramzlari hisoblanadi. Tasavvuringiz asosida berilgan mavzu bo'yicha mustaqil rasm ishlang.



1. Rasmda qanday ko'rinish va nimalar tasvirlangan?
2. Archa qanday bezatilgan?



Archa rasmini ishlash bosqichlari.

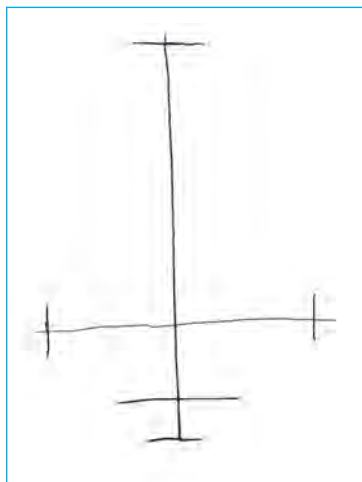

Tasvirni qog'ozga joylashtirish.

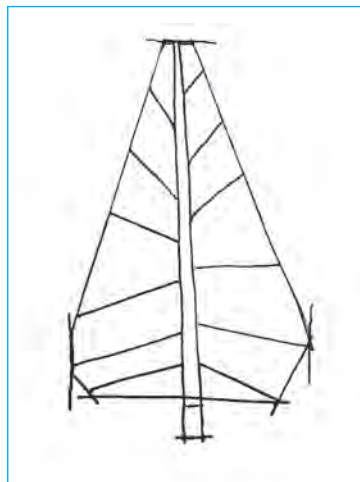

Tasvirni xomaki ishlash.

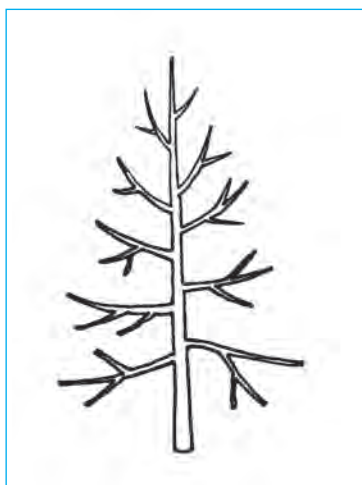

Tasvirni qalamda yakunlash.



Rasmni rang bilan yakunlash.



Archa o'yinchog'i rasmini ishlash bosqichlari.

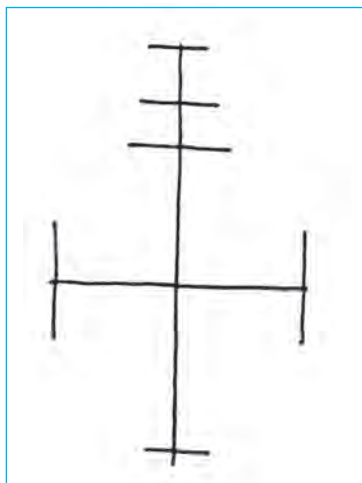

Tasvirni qog'ozga joylashtirish.

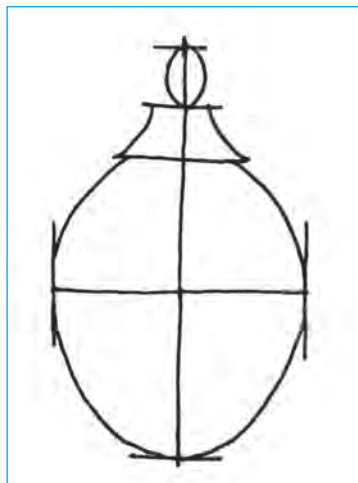

Tasvirni xomaki ishlash.

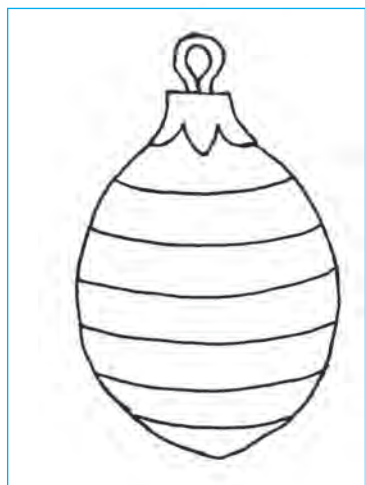

Tasvirni qalamda yakunlash.



Rasmni rang bilan yakunlash.



Qorbobo rasmini ishlash bosqichlari.



Tasvirni qog'ozga joylashtirish.



Tasvirni xomaki ishlash.



Tasvirni qalamda yakunlash.



Rasmni rang bilan yakunlash.



Qorqiz rasmini ishlash bosqichlari.

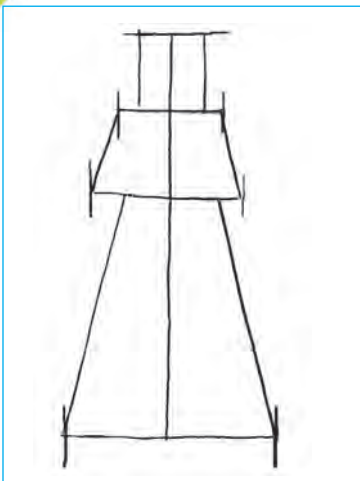

Tasvirni qog'ozga
joylashtirish.



Tasvirni
xomaki ishlash.



Tasvirni qalamda
yakunlash.



Rasmni rang bilan
yakunlash.



Yuqorida berilgan bosqichlar asosida rasm
ishlang.



Qor parchasi rasmini ishlash bosqichlari.

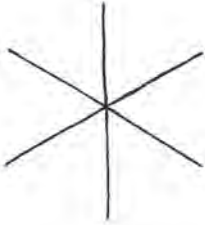

Quyidagi rasmlarni joylashtirishda qanday xatoga yo'l qo'yilgan? O'lchamlar to'g'ri tanlanganmi?



Sinfda chizilgan «Archa bayrami» mavzuidagi kompozitsiyani oxiriga yetkazing.



ORALIQ NAZORAT DARSI

I. Test savollari:

1. Quyidagi naqshlardan qaysi biri kvadrat shaklida?



2. Qaysi ertak qahramonlari yomon xulqqa ega?

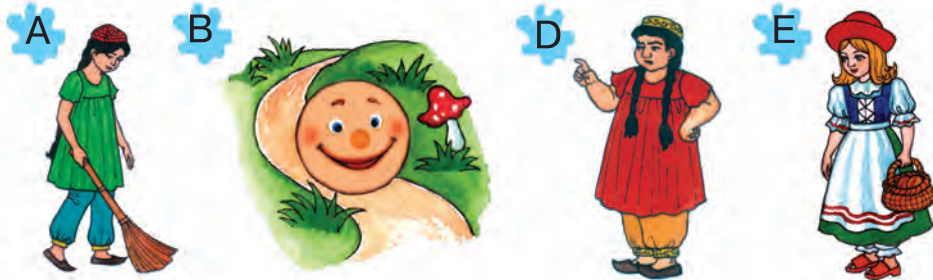

3. Qaysi rasmda kompozitsiya tasvirlangan?



4. Quyidagilardan qaysi biri rangtasvir asari hisoblanadi?



II. Amaliy topshiriq.

Kuzgi ishlar mavzusidagi rasmlardan foydalanib, kuzgi mevalarni plastilindan yasab dasturxon tuzang.

III CHORAK



S. Sulaymonov. *Qishning boshlanishi*

Bu chorakda siz:

- qish faslidagi tabiat manzaralari rasmini ishlashni;
- sovuq ranglar bilan tanishib, ularning ishlatilishini;
- hayvonlar haykalchalarini ishlashni;
- mavzu asosida tabriknomalar ishlashni o'rganasiz.

«QISH MANZARASI» MAVZUSIDA RASM ISHLASH



S. Sulaymonov. *Qish*

Qish — juda ajoyib fasl. Hammayoq oppoq qorga burkangan. Quyosh kuchsiz zarrin nurlarini sochmoqda. Kunlar sovuq. Daraxtlar uyquga ketgan. Qarg'alar yegulik qidirish bilan ovora.



1. Yuqoridagi suratda nimalar tasvirlangan?
2. Rassom qish faslini tasvirlashda ko'proq qaysi ranglarni ishlatgan?



Sovuq ranglar:

-  — to‘q ko‘k;
-  — ko‘k;
-  — binafsha;
-  — moviy;
-  — yashil.



Sovuq ranglar muz, suv, osmon ranglarini eslatadi. Bu ranglardan ko‘proq qish faslini tasvirlashda foydalaniladi.



Quyidagi rasmda qaysi sovuq ranglar ishlatilganligini aniqlab ayting.



X. Ro‘zmetov. *Qish*



«Qish manzarasi» mavzusida rasm ishlang. Bunda qor, qishki o'yinlar, Qorbobo ko'rinishlaridan foydalanishingiz mumkin.



1. Qaysi ranglar sovuq ranglarga kiradi? Nega ular bunday nomlanadi?
2. Kamalakda qaysi sovuq ranglar bor?



1. Sinfda ishlangan «Qish manzarasi» rasmini oxiriga yetkazing.
- 2*. Sinfda ishlangan «Qish manzarasi» rasmi asosida hikoya yozing.



Ikki o'xshash Qorbobo rasmini toping.



YUK MASHINASI RASMINI ISHLASH



Birinchi sinfda yengil avtomashinalar chizishni o'rganib olgan edingiz. Endi esa yuk avtomashinalarini chizishni o'rganasiz.

Yuk avtomashinalari turli kattalikda bo'ladi. Shahar va qishloqlarda foydalaniladigan yuk mashinalari kichikroq hajmda bo'lsa, shaharlararo uzoq yo'lga qatnovchi avtomashinalar kattaroq bo'ladi.



1. Qanday yuk mashinalarni ko'rgansiz?
2. Ular qanday qismlardan iborat?



Yuk mashinasi rasmini ishlash bosqichlari.

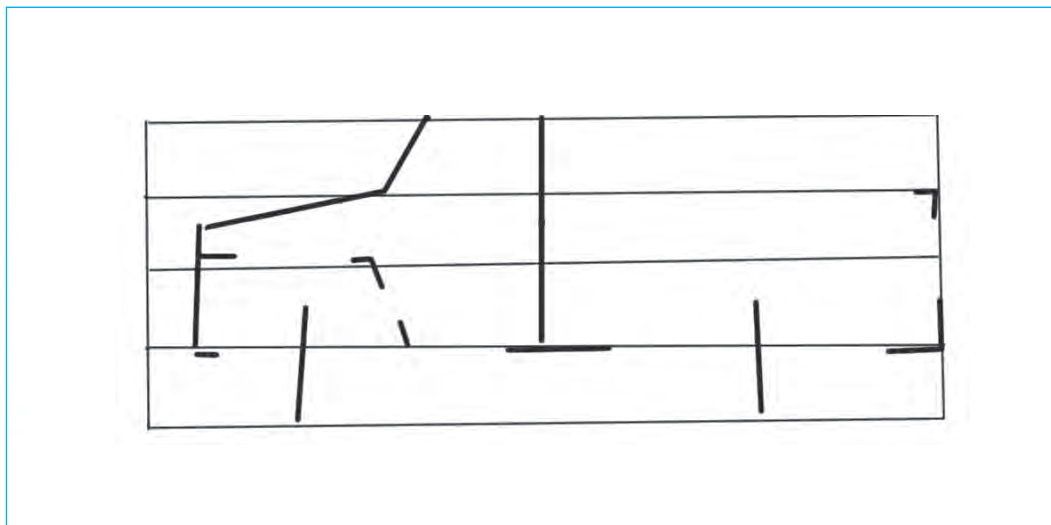

Tasvirni qog'ozga joylashtirish.

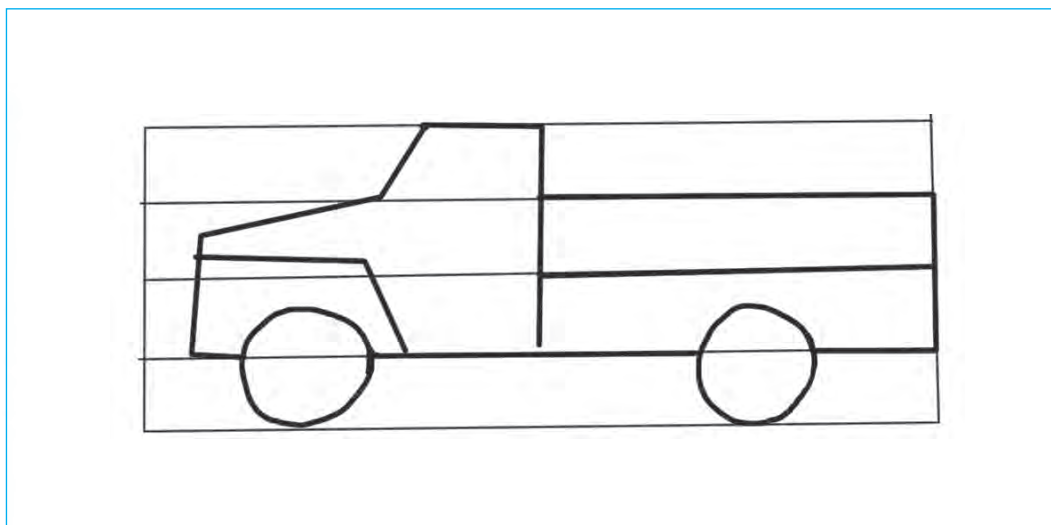

Qalamda xomaki ishlash.



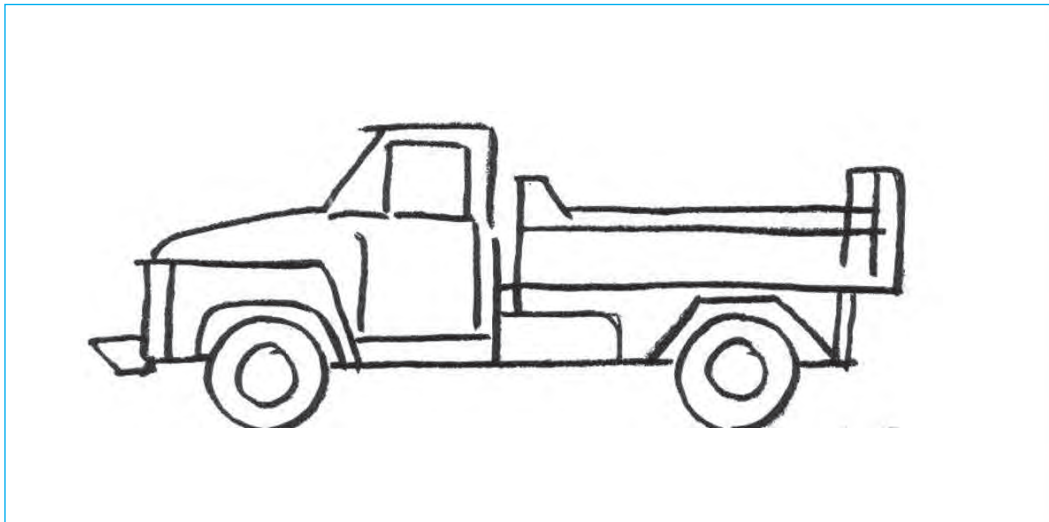

Tasvirni qalamda yakunlash.



Rasmni rang bilan yakunlash.



Berilgan rasmlar va namunaga qarab avtomashina rasmini chizing.



1. Avtomashinalar asosan qaysi ranglarda bo'ladi?
2. Ularni ifodalashda nimalarga ahamiyat berish kerak?



1. Ixtiyoriy avtomashina rasmini chizing.
- 2*. Plastilindan avtomashina yasang.



QUSH RASMINI ISHLASH



Siz, albatta, qushlarni kuzatgansiz. Ularning yurtimizda uchramaydiganlarini esa televizor orqali yoki hayvonot bog'ida tomosha qilgansiz.



1. Yuqoridagi rasmlarda nimalar tasvirlangan?
2. Ular sizga yoqdimi? Nima uchun?



Qush rasmini ishlash bosqichlari.



Tasvirni qog'ozga joylashtirish.

Tasvirni xomaki ishlash.

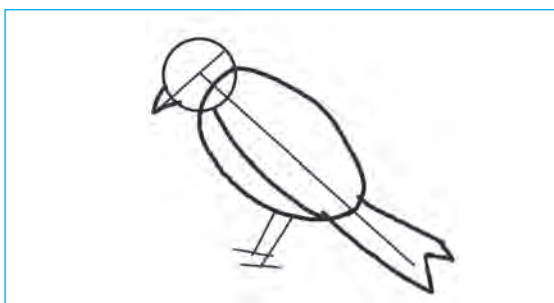

Tasvirni qalamda yakunlash.

Rasmni rang bilan yakunlash.





Uchayotgan qaldirg'och rasmini ishlash bosqichlari.

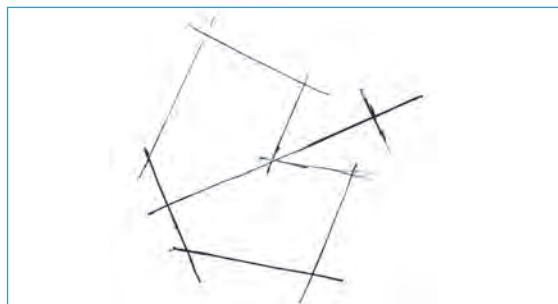

Tasvirni qog'ozga
joylashtirish.

Tasvirni xomaki ishlash.



Tasvirni qalamda
yakunlash.

Rasmni rang bilan
yakunlash.





«Qanotli do'stlar» mavzusida tasavvuringizdagi rasmni ishlang. Bunda qushlarning shakli, rangi, bir-biriga nisbatan katta-kichikligini, ular asosan, bahor faslida daraxtlarning shoxlariga in qurishlarini inobatga oling.



1. Sinfda ishlangan qushlar rasmini oxiriga yetkazing.
- 2*. «Qanotli do'stlar» mavzusida rasm ishlang.



OT (TUYA, MUSHUK, FIL KABI HAYVONLAR) HAYKALINI YASASH

Tabiatda ko'plab jonivorlar uchraydi. Ular yovoyi va uy hayvonlariga bo'linishini juda yaxshi bilasiz. Undan tashqari hayvonlar tuzilishiga, rangiga va turiga qarab ham farqlanadi. Har bir odamning o'zi yoqtirgan jonivori bo'ladi.



Ot haykalini yasash bosqichlari.

1



Haykalcha qismlari uchun bo'laklar ajratib olinadi.

2



Asos qismi qirqib, oyoqlar hosil qilinadi.

3



Bosh qismi tana qismiga birlashtiriladi.

4



Otning yoli, dumi, quloqlari yopishtirilib yakuniy ishlov beriladi.



Tuya haykalini yasash bosqichlari.

1



Loy yoki plastilindan tuya haykalchasi qismlariga mos bo'laklar ajratib olinadi.

2



Haykalchanning asosiy qismi haykaltaroshlik pichoqchasi bilan qirqib, oyoqlar hosil qilinadi.

3



Haykalchanning bosh qismi, o'rkachlari tana qismiga birlashtiriladi.

4



Haykalchaga yakuniy ishlov beriladi.



O'zingiz yoqtirgan hayvon haykalini yasang.



**Hayvonlar haykalini yasashda ta-
biatdagi hayvonlarga qarang va
namunada ko'rsatilgan usullardan
foydalaning.**

1



Fil haykalchasi
qismlariga mos
bo'laklar ajratib olinadi.

2



Fil qismlariga
shakl berilib,
birlashtiriladi.

3



Filning mayda
qismlari birlashtiriladi.

4



Haykalchaga yakuniy
ishlov beriladi.



Mushuk haykalini yasash bosqichlari.

1

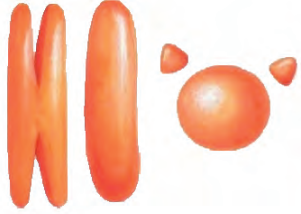

Loy yoki plastilindan mushuk haykalchasi qismlariga mos bo'laklar ajratib olinadi.

2



Haykalchanning asosiy qismi haykaltaroshlik pichoqchasi bilan qirqib, oyoqlar hosil qilinadi.

3



Haykalchanning bosh qismi, dumi tana qismiga birlashtiriladi.

4



Haykalchaga yakuniy ishlov beriladi.



1. Sizga qaysi hayvon yoqadi? Nima uchun?
2. Uning tuzilishi va rangini ayting?



Yasalgan haykallardan iborat kompozitsiya tuzing.



NAQSH NAMUNALARIDAN NUSXA KO'CHIRISH



1. Rasmlardagi naqshlarni qayerlarda uchratish mumkin?
2. Ularda ranglar qanday tanlangan?



Soʻzanalarda kvadrat naqshlarning ishlatilishi.



1. Rasmdagi soʻzanada bezak sifatida qanday shakldagi tasvirlardan foydalanilgan?
2. Unda qaysi ranglardan foydalanilgan?
3. Soʻzanalarda yana qanday naqsh turlari ishlatiladi?



Naqshda bezak gullarni joylashtirish bosqichlari.

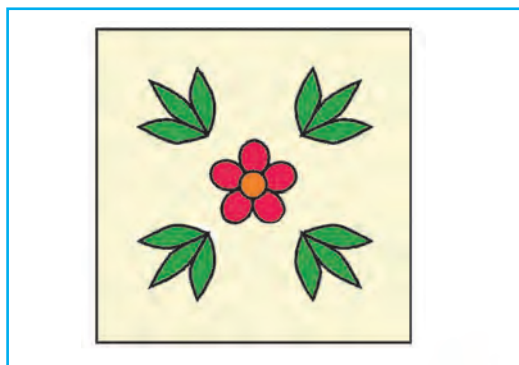
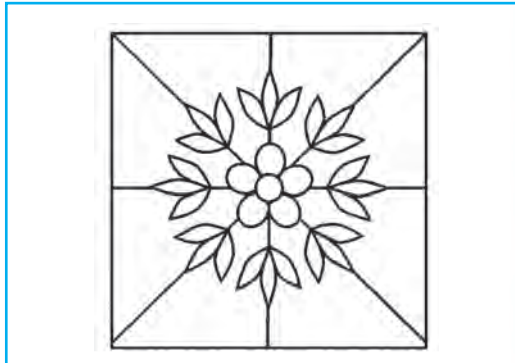
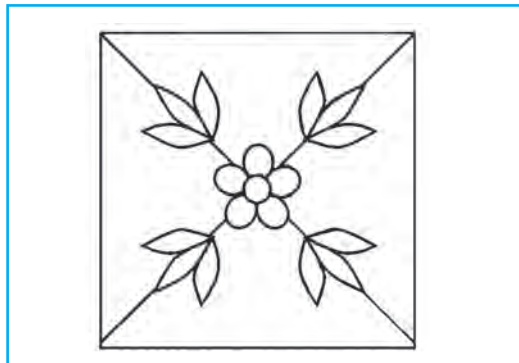
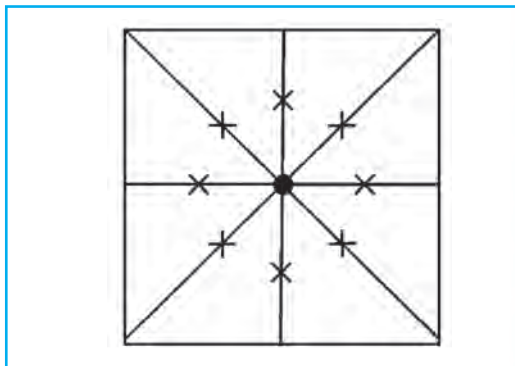
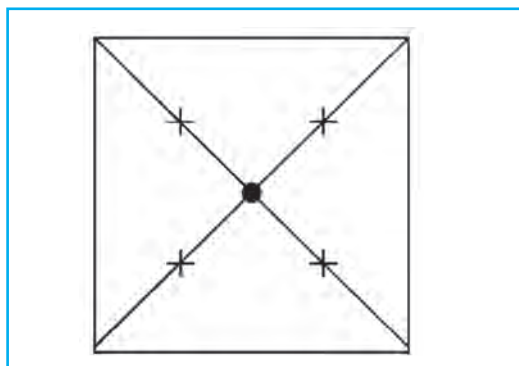
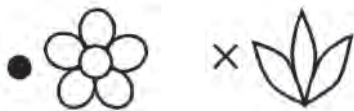



1. Bezak gul och rangda bo'lsa, naqsh asosi to'q rangda bo'ladi.
2. Bezak gul to'q rangda bo'lsa, naqsh asosi och rangda bo'ladi.



47-betda berilgan gul bezaklaridan birini yoki bir nechasini tanlab, kvadrat naqsh ishleng.



1. Do'ppida qanday bezak gullari ifodalangan?
2. Naqsh gullarini bo'yashda nimalarga e'tibor berish kerak?
3. Gulli naqshlar bilan ko'proq nimalar bezatiladi?



Rasmlarda berilgan naqshlardan qaysi biri kvadrat naqsh ekanligini ayting.

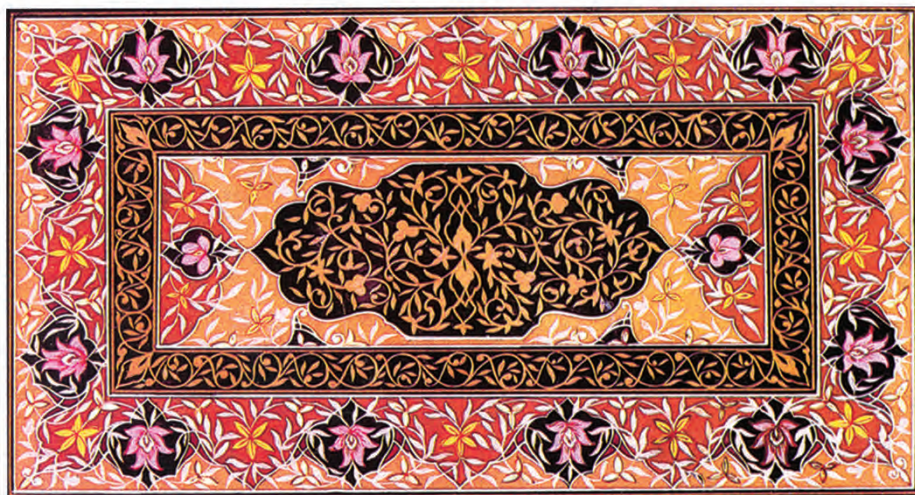

1. Sinfda ishlangan naqshni oxiriga yetkazing.
- 2*. Uyingizdagi gilamdan andoza olib, gilam rasmni islang.



DOIRA SHAKLIDAGI NAQSH KOMPOZITSIYASINI CHIZISH



1. Naqshlar qanday shakllarda bo'radi?
2. Doira shaklidagi naqshlarni qayerlarda uchratish mumkin?



Doiraviy naqshlarni ishlash bosqichlari.

1

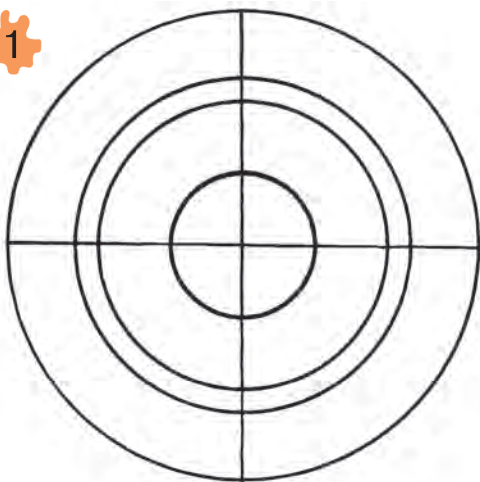

2

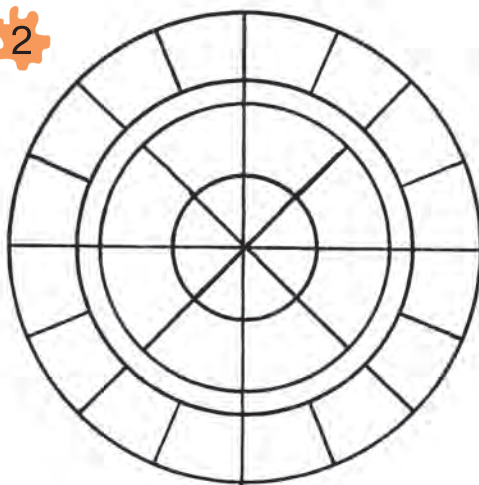

Tarh olinadi.

3

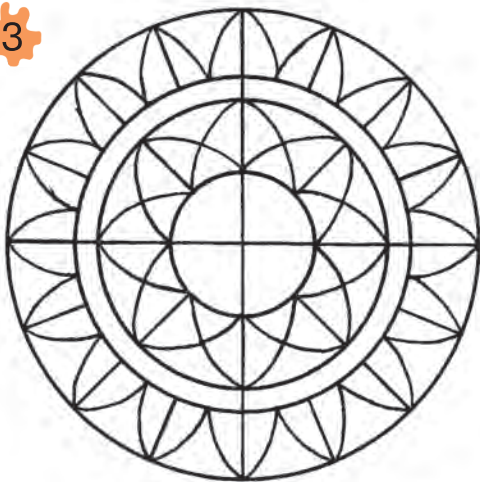

4



Bezak gullari chiziladi.



Doira shaklidagi naqsh kompozitsiyasini chizing.



1. Naqshlarda qanday ranglardan ko'proq foydalaniladi?
2. Doira shaklidagi naqshlar sizga yoqadimi? Nima uchun?



1. Doira shaklida ishlanayotgan rasmni oxiriga yetkazing va bo'yang.
2. O'zingiz istagan naqsh gullaridan iborat doira shaklidagi naqsh ishlang.



8-MART BAYRAMIGA TABRIKNOMA ESKIZINI ISHLASH



8-mart — Xalqaro xotin-qizlar bayrami. Bu kunni yer yuzidagi ko‘plab mamlakat xalqlari bayram qiladi.

O‘zbekistonda ham 8-mart kuni dam olish kuni deb belgilab qo‘yilgan. Bu kuni buvijonlarga, onajonlarga hurmat ko‘rsatilib, ular e‘zozlanadi.



1. 8-mart kuni kimlarni tabriklaysiz?
2. Qiz bola bo‘lsangiz, sizni kimlar tabriklagan?



Tabriknoma eskizini ishlash bosqichlari.

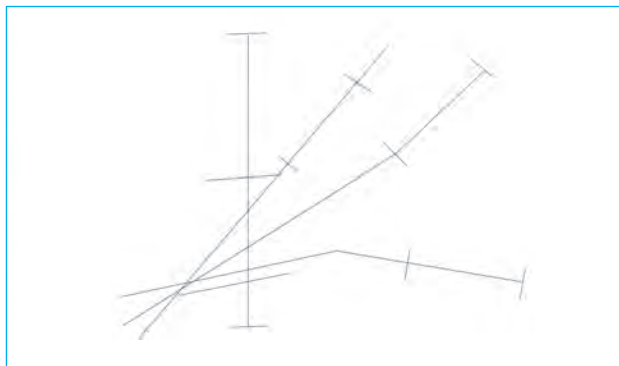

Tasvirni qog'ozga joylashtirish.

Tasvirni xomaki ishlash.

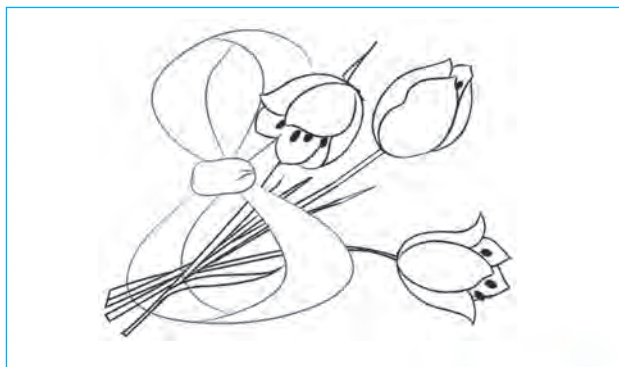

Tasvirni qalamda yakunlash.



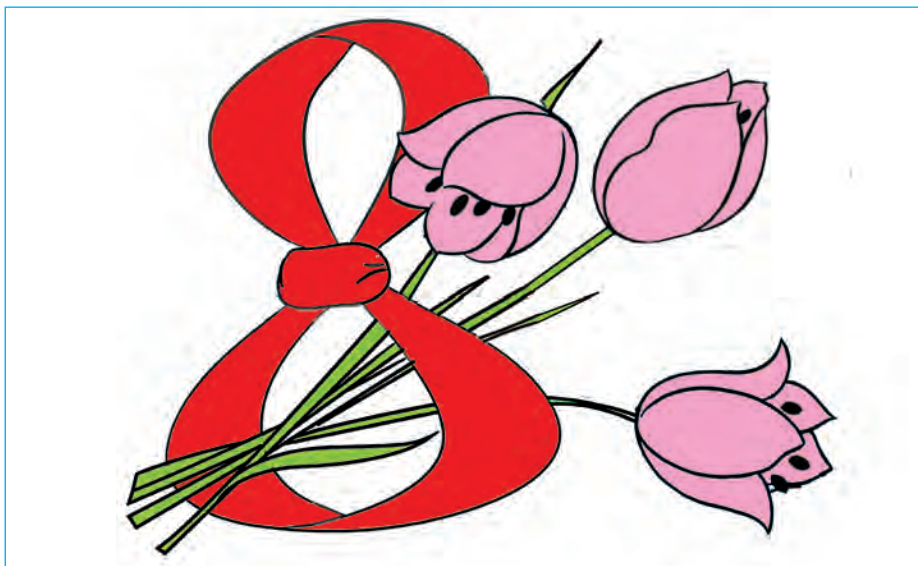

Rasmni rang bilan yakunlash.



Berilgan tabriknomalar asosida tabriknoma ishlang.



1. 8-martga atalgan tabriknomada nimalarni aks ettirish mumkin?
2. Qaysi ranglardan ko'proq foydalangan ma'qul?



1. «8-mart bayrami bilan» tabriknomasini akvarelda bo'yang.
2. «8-mart» deb nomlangan ixtiyoriy tabriknoma eskizini chizing.



«NAVRO‘Z — BAHOR BAYRAMI» MAVZUSIDA RASM ISHLASH

Navro‘z yurtimizda mustaqillikka erishganimizdan so‘ng qaytadan nishonlana boshlandi. Navro‘z — bahor, yangilanish bayramidir. Shuning uchun Navro‘z yurtimizda katta shodiyonalar bilan kutib olinadi. Navro‘z kelishi bilan shahar va qishloqlarimiz tabiati go‘zallashadi.

Qir va dalalar yam-yashil tus oladi, rangbarang gullarga burkanadi.



G. Chernuxin. *O‘zbek zamini*





Momolarimiz sumalak, halim kabi milliy taomlar tayyorlashadi. Bolalarning ham bahorda sevib o'ynaydigan mashg'ulotlari ko'payadi.



1. Navro'z qanday bayram? U haqida so'zlab bering.
2. Yuqoridagi rasmda kimlar va nimalar tasvirlangan?



«Navro'z — bahor bayrami» mavzusida rasm ishlang. Bunda kompozitsiya elementlarini to'g'ri joylashtirilishiga, perspektivaga, narsalar ranglarining to'g'ri tanlanishiga e'tibor bering.



«Navro‘z — bahor bayrami» mavzusidagi rasm tasviriy san‘atning maishiy janriga mansub.

Odamlar hayotidagi voqealarni tasvirlash tasviriy san‘atning **maishiy janri** deb aytiladi.



1. Rasmdagi manzarani tavsiflab bering.
2. Siz bayramni qanday tasavvur qilasiz?

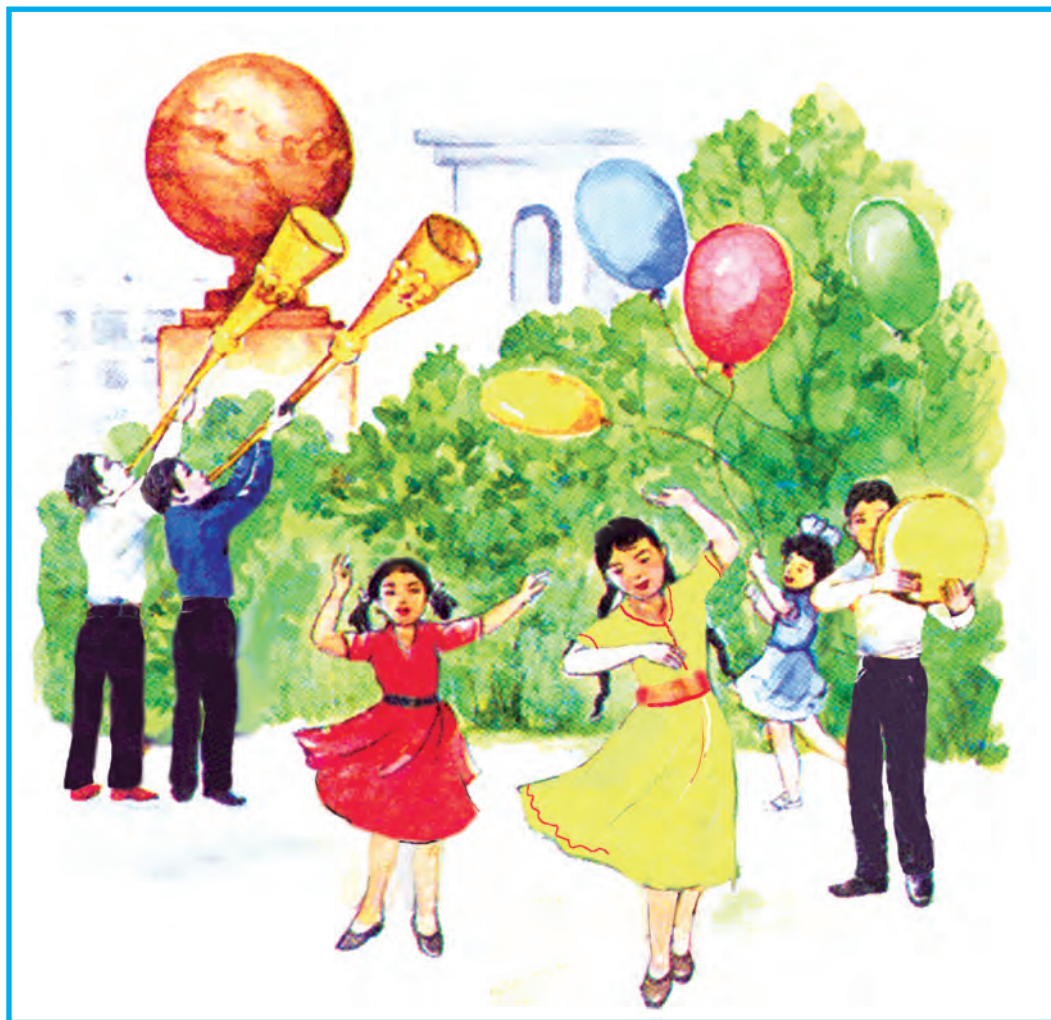

1. Tasviriy san'atning maishiy janrida qanday voqeliklar tasvirlanadi?
2. Bahor tasvirida qaysi ranglar ko'proq ishlatiladi?



«Navro'z – bahor bayrami» mavzusidagi rasmni ishlashni oxiriga yetkazing.



Ro'zi Choriyev
(1931 — 2004)



R. Choriyev.
Qumqo'rg'on olmalari

Ro'zi Choriyev — O'zbekiston Badiiy akademiyasi akademigi, O'zbekiston xalq rassomi. U portret, tarixiy va maishiy janrlarda ijod qilgan. Rassomning maishiy janrdagi «Suhbat», «Xumson oqshomi», «Nay. Cho'pon bola» va boshqa asarlari mashhurdir.



«MENING MAKTABIM» MAVZUSIDA RASM ISHLASH



Bizning mamlakatimizda o‘quvchilarning yaxshi o‘qishlari uchun hamma sharoitlar yaratilgan.



1. Rasmda nimalarni ko‘ryapsiz?
2. Rasmdagi maktabning tuzilishi, shakli qanday?



Bino tasvirini qalamda chizish bosqichlari.

1

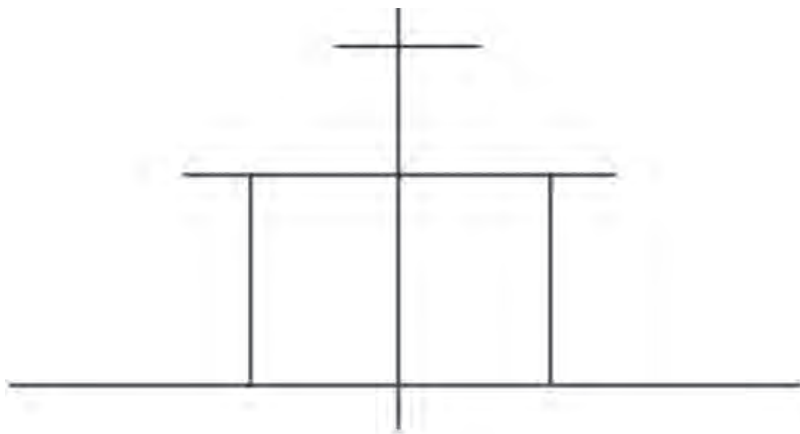

Tasvirni qog'ozga joylashtirish.

2



Qalamda xomaki ishlash.



3



Tasvirni qalamda yakunlash.

4



Tasvirga rang bilan yakuniy ishlov berish.



Maktab hovlisiga chiqib uni kuzating. Sinfda qora qalam yordamida «Bizning maktab» mavzusida rasm chizing.



1. Maktab rasmini chizganda asosiy e'tibor nimalarga qaratiladi?
2. Qora qalam yordamida to'q ranglarni qanday hosil qilish mumkin?



1. Sinfda ishlangan «Bizning maktab» rasmini qalamda yakunlang.
- 2*. «Bizning mahalla» mavzusida rasm ishlang.



ORALIQ NAZORAT DARSI

I. Test savollari:

1. To'rtburchak shaklidagi naqsh keltirilgan bandni aniqlang:

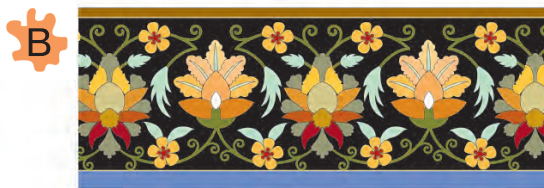

2. Sovuq ranglar to'g'ri ko'rsatilgan bandni aniqlang:

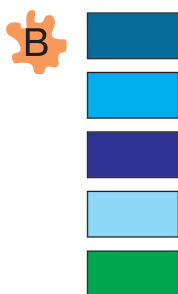
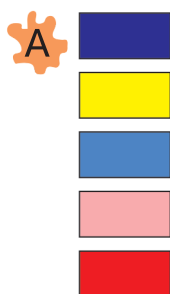

3. Haykal ishlash bosqichlarini to'g'ri ketma-ketlikda joylashtiring.

A



B



D



E



4. Qaysi bandda yo'lsimon naqsh tasvirlangan?

A



B



D



E



II. Topshiriq.

O'zingiz ishlagan «Navro'z — bahor bayrami» nomli rasm haqida hikoya qilib bering.

IV CHORAK



Bu chorakda siz:

- haykal ishlash malakalaringizni yanada takomillashtirasiz;
- ertak asosida haykallardan tashkil topgan kompozitsiyalar ishlaysiz;
- mavzu asosida rangtasvir ishlashni davom ettirasiz;
- bahor faslidagi tabiat manzarasini rasmini ishlaysiz.

DARAXT BARGI RASMINI ISHLASH

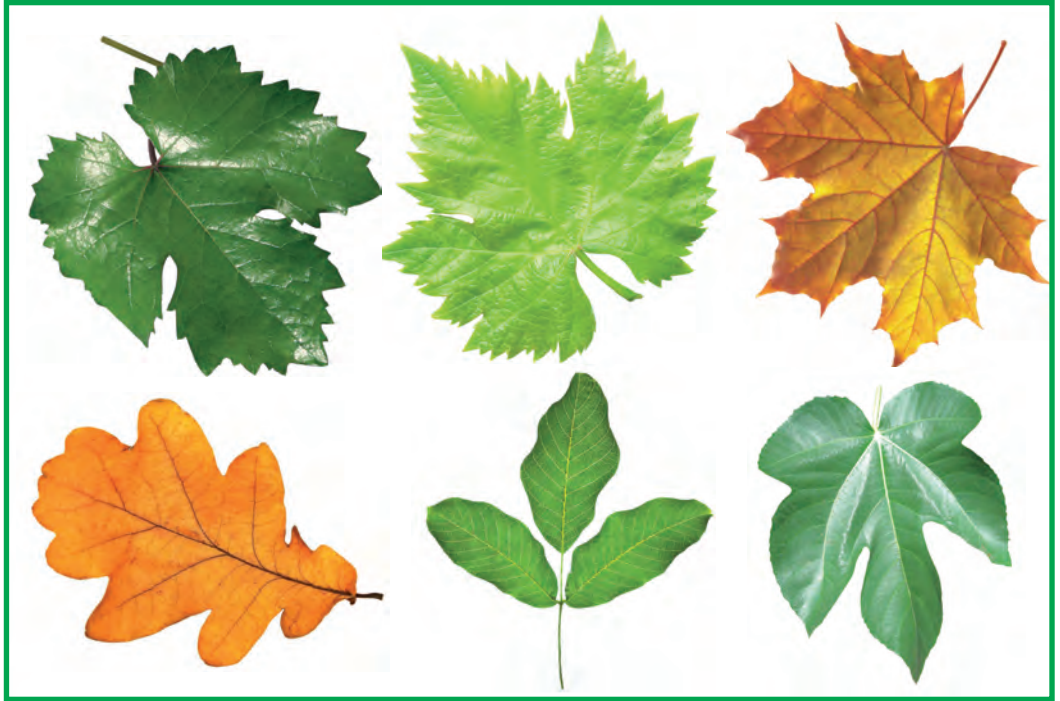

1-sinfda oddiy tuzilishdagi daraxt barglarini chizishni o'rgangan edingiz. Endi murakkab tuzilishdagi barglar rasmini chizishni o'rganasiz. Bunday barglarga tok, chinor, anjir, yong'och kabi daraxt barglari misol bo'la oladi.



Berilgan daraxt barglarining tuzilishi, shakli va bir-biridan qanday farqlanishiga e'tibor bering!



Chinor daraxti bargining rasmini ishlash bosqichlari.

1

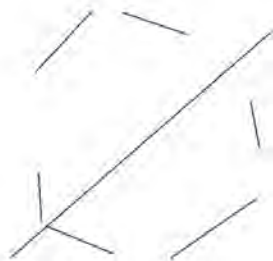

Tasvirni qog'ozga joylashtirish.

2

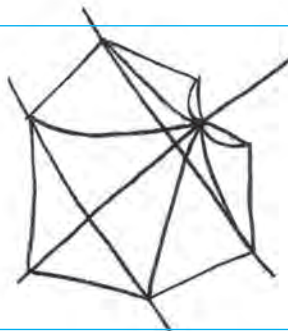

Qalamda xomaki ishlash.

3

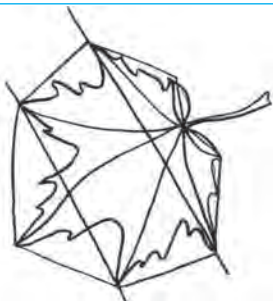

Tasvirni qalamda yakunlash.

4



Tasvirni rang bilan yakunlash.



Eman daraxti bargining rasmini ishlash bosqichlari.

1



Tasvirni qog'ozga joylashtirish.

2



Qalamda xomaki ishlash.

3



Tasvirni qalamda yakunlash.

4



Tasvirni rang bilan yakunlash.



Siz bu rasmlardan foydalanib, o'zingiz istagan barg rasmini chizing.



O'zingiz yoqtirgan barg rasmini bo'yang.



«SHOLG‘OM» ERTAGI ASOSIDA HAYKALCHALAR

Bir bor ekan, bir yo‘q ekan, qadim zamonda bir dehqon bobo bor ekan. Bir kuni bobo sholg‘om ekibdi.



Sholg‘om kattakon bo‘lib, o‘sib yetilibdi.

Bobo sholg‘omni tortib olmoqchi bo‘libdi. Tortib, tortib, tortib ololmabdi. Shunda bobo yordamga

buvini chaqiribdi. Buvi boboni, bobo sholg'omni tortibdi-tortibdi, biroq sholg'om o'rnidan qo'zg'almabdi. Buvi nabirasini yordamga chaqiribdi, nabira kuchukni, kuchuk mushukni, mushuk esa sichqonchani chaqiribdi.

Sichqon mushukni, mushuk kuchukni, kuchuk nabirani, nabira buvini, buvi boboni, bobo sholg'omni tortishibdi-tortishibdi va, nihoyat, tortib olishibdi.



6—7 o'quvchi birgalikda «Sholg'om» ertagi qahramonlari haykallarini plastilindan yasang. Ularni yasashda turli usullardan foydalaning.

Yasalgan haykallarni ertak mazmuniga ko'ra turlicha joylashtirish mumkin.

Masalan, faqat sholg'om va boboni joylashtir-
sak, ertakning bir ko'rinishi hosil bo'ladi.

Boshqacharoq joylashtirib esa ertakning bosh-
qa kompozitsiyasini hosil qilamiz.



**«Sholg'om» ertagi qahramonlari
haykallarini alohida-alohida
bo'laklardan ishlash.**



Sholg'om.



Qizcha.

Kampir.

Chol.



Kuchuk.



Mushuk.



Sichqon.



1. Kompozitsiya nima?
2. «Kuch – birlikda» maqolini «Sholg‘om» ertagi asosida izohlab bering.



1. O‘zingiz yoqtirgan ertak qahramonlari haykallaridan foydalanib, ertak mazmuniga mos boshqa kompozitsiya islang.
- 2* . «Men yoqtirgan ertak» qahramonlari haykallarini yasang.



TUYA RASMINI ISHLASH

Sharq xalqlari qadimda Buyuk ipak yo'li orqali tuyalar karvonida sahrolardan o'tib, insonlar hayoti uchun zarur bo'lgan mahsulotlarni uzoq o'lkalardan yurtimizga olib kelganlar. Shuning uchun «karvon» deyilganda ko'z oldimizga tuyalar keladi.



B. Hojimatov. *Karvon*



1. Karvon haqida nimalarni bilasiz?
2. Rasmda qanday ko'rinish va nimalar tasvirlangan?
3. Bu rasm tasviriy san'atning qaysi turiga mansub?



Tuya rasmini ishlash bosqichlari.

1



Tasvirni qog'ozga joylashtirish.

2



Tasvir o'lchamlarini belgilash.

3

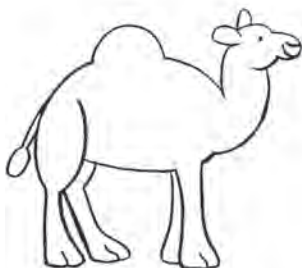

Tasvirni qalamda yakunlash.

4

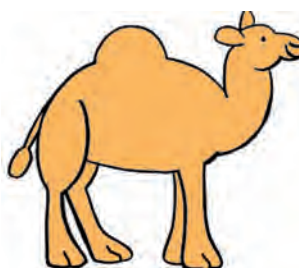

Tasvirni rang bilan yakunlash.





Berilgan rasmlardan foydalangan holda tuya rasmini chizing.

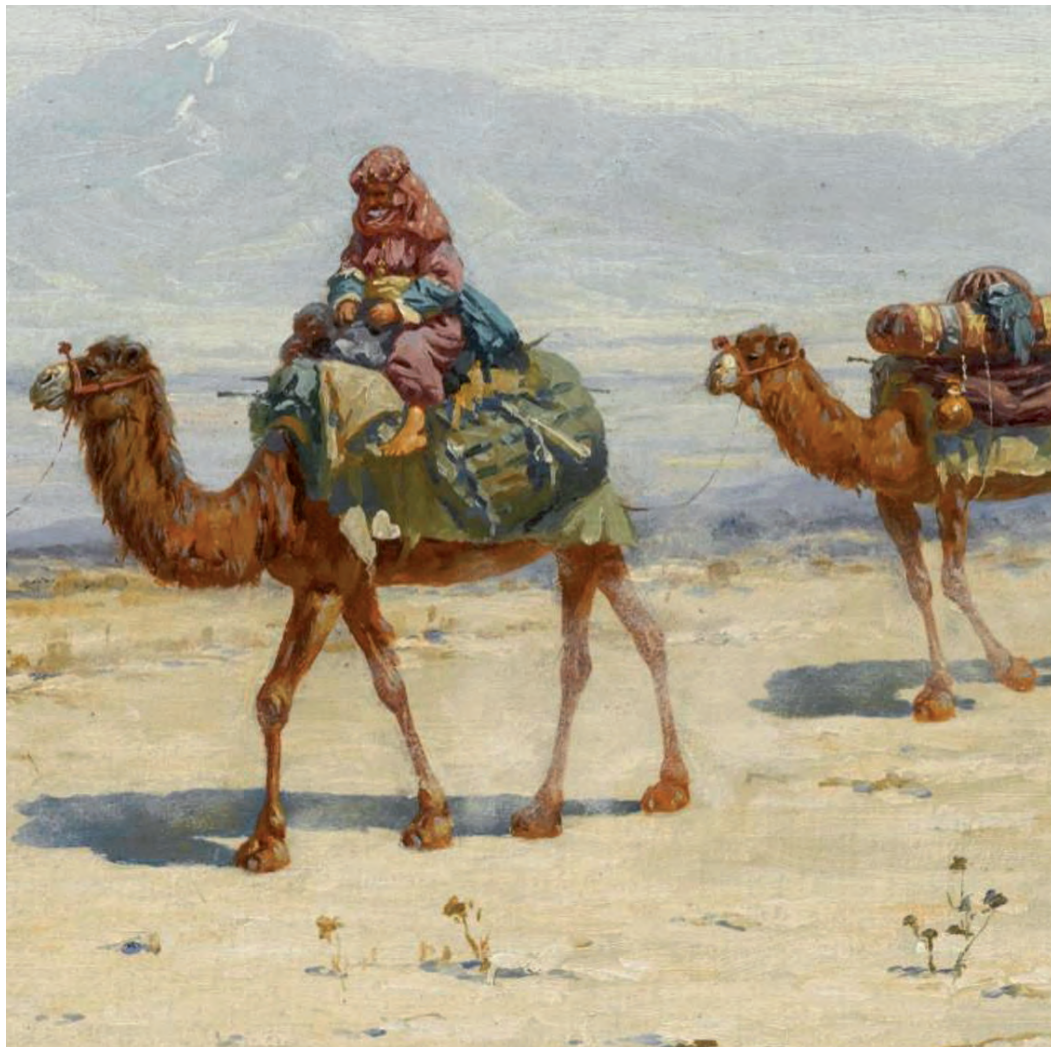

K. Zommer. *Sharq sayyohlari*



1. Tuyalar qanday ko'inishda bo'ladi?
2. Ularning turlarini bilasizmi?





Quyidagi rasmlarni ishlashda qanday xatoga yo'l qo'yilgan?



1. Tuya rasmini bo'yang.

2*. Ikki o'rkachli tuya rasmini chizing.



**«BOBOMNING BOG'I»
MAVZUSIDA RASM
ISHLASH**

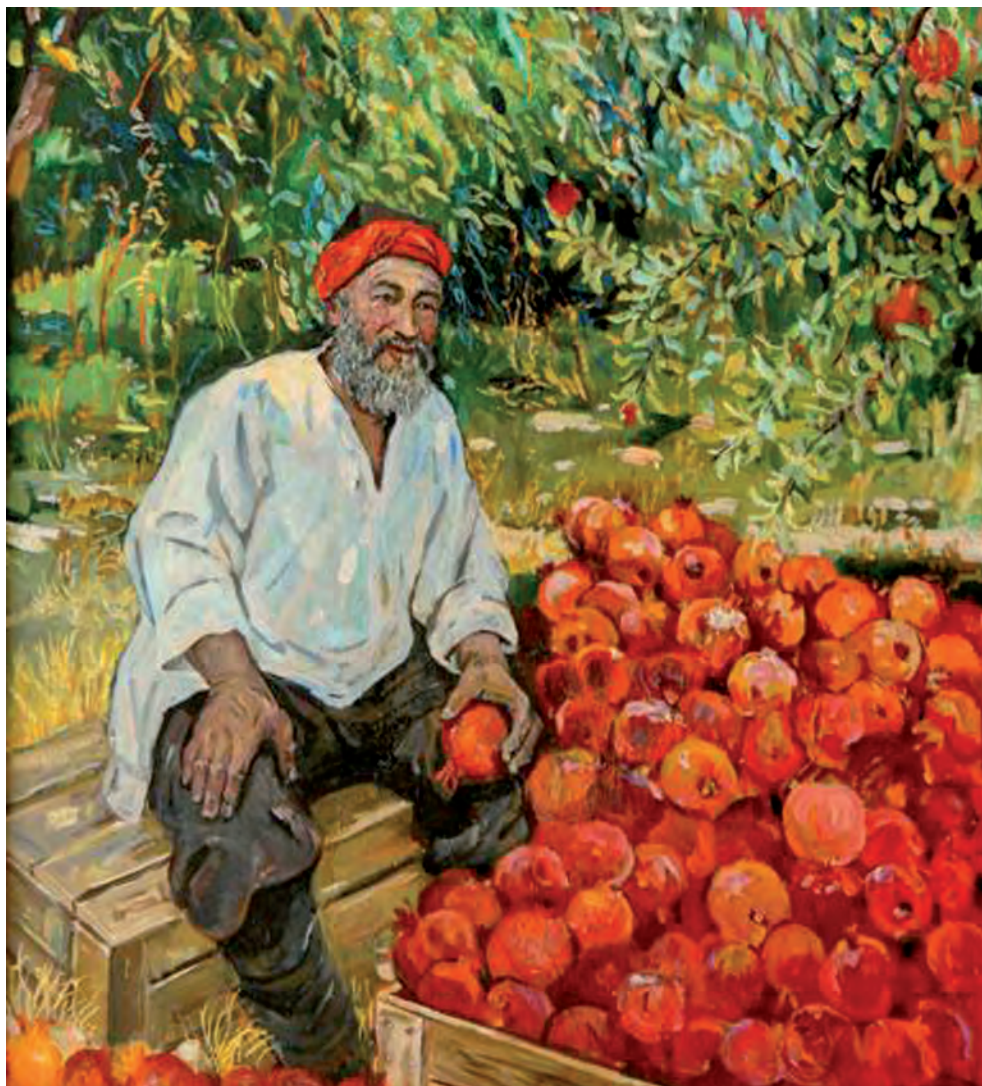

R. Ahmedov. *Bog'da*



1. Fotosuratlarda qaysi fasllar tasvirlangan?
2. Fasl o'zgarishi bilan ranglarning ham o'zgarishini izohlang.



X. Rahmonov. *Yoz zavqi*

Quyidagi rasmlarni diqqat bilan kuzating va ularni alohida-alohida sharhlang. So'ng bu rasmlarni bir-biri bilan taqqoslang. Ularda ranglardan fasllarni ifodalovchi vosita sifatida foydalanilgan. Siz ham rasm chizishda ranglardan to'g'ri foydalanishga harakat qiling.



1. Rasmlarda qaysi fasllar tasvirlangan?
2. Fasllarni tasvirlashda rassom qaysi rangdan ko'proq foydalangan? Sababi nimada deb o'ylaysiz?



«Bobomning bog'i» mavzusida rasm ishlang.



«Bobomning bogʻi» mavzusidagi rasmni ishlash bosqichlari.

1



Tasvirni qogʻozga joylashtirish.

2

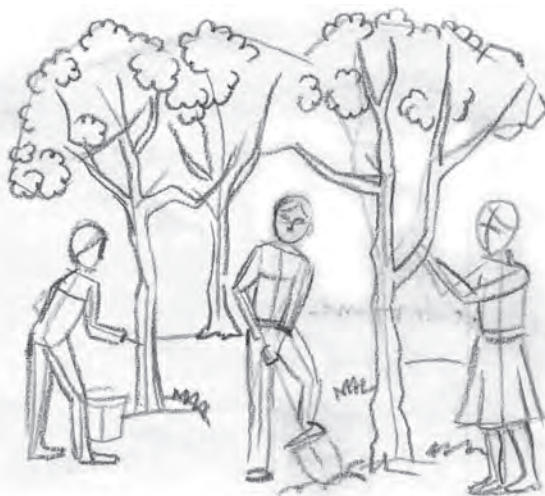

Tasvirni aniqlashtirish.

3



Tasvirni qalamda yakunlash.

4



Tasvirni rang bilan yakunlash.



1. Yilning to'rt faslida bog'larda bo'ladigan o'zgarishlarni eslang va aytib bering.
2. Bahor faslini tasvirlashda ko'proq ishlatiladigan ranglarni sanang.



1. Sinfda ishlangan «Bobomning bog'i» mavzusidagi rasmni oxiriga yetkazing.
- 2*. Bog'ning biror fasldagi rasmini ishlang va uni oldin ishlagan rasmingiz bilan taqqoslang.



L. Abdullayev. *Uzum*



«UCH JO‘JA VA O‘RDAKCHA» SHE‘RI ASOSIDA HAYKALCHALAR YASASH

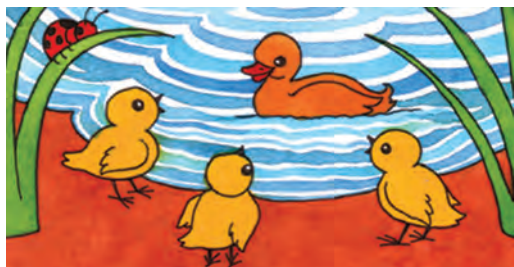

Uch jo‘ja va o‘rdakcha

(She‘rdan parchalar)

S. Abduqahhor

...Ko‘prik topa olmay,
Uch jo‘ja xafa, hayron.
Qanday o‘tsak bo‘ladi:
O‘ylab qoldi uchovlon...

...Shu chog‘ ular oldiga
Kelib qoldi o‘rdakcha.
O‘zi kichik, sap-sariq,
Jo‘jalardan bo‘lakcha...

...Hammasini o‘tkazdi,
Endi do‘st bo‘lib yashar.
Uch jo‘ja, bir o‘rdakcha
Hech urinmay o‘ynashar.



Rasmda qanday voqea tasvirlangan?



Jo'ja haykalchasini (o'yinchoq jo'jaga qarab) ishlash bosqichlari.

1



2



3



O'rdak haykalchasini (o'yinchoq o'rdakka qarab) ishlash bosqichlari.

1



2



3





«Uch jo'ja va o'rdakcha» she'ri asosida haykaltaroshlik kompozitsiyasini yaratish.



Asosni ishlash.



Haykalchalarni joylashtirish.



Guruhlarga bo'linib, «Uch jo'ja va o'rdakcha» she'ri asosida jo'ja va o'rdakchalar haykallarini yasang.



1. Ishlangan haykalchalarni she'r mazmuniga mos ravishda joylashtirib, kompozitsiya yarat-ing.

2*. «Uch jo'ja va o'rdakcha» she'ri asosida rasm ishlang.



YAKUNIY NAZORAT DARSİ

I. Test savollari:

1. Qaysi rasmda tasvir to'g'ri joylashgan?

A



B



D



E



2. Qaysi rasmda yo'lsimon naqsh tasvirlangan?

A



B



D



3. Qaysi rasm to'g'ri ishlangan?

A



B



D



E



4. Kvadrat shaklidagi naqshni aniqlang:



5. Qaysi bandda haykaltaroshlik kompozitsiyasi berilgan?



6. Quyidagi rasm janrlarining ketma-ketligi qaysi bandda to'g'ri belgilangan?

A.

1. Manzara.
2. Portret.
3. Natyurmort.

B.

1. Manzara.
2. Natyurmort.
3. Portret.

D.

1. Natyurmort.
2. Portret.
3. Manzara.



7. Ertaklarga ishlangan illyustratsiyalar ketma-ketligi qaysi bandda to'g'ri belgilangan?

A.

1. «Bo'g'irsoq».
2. «Sholg'om».
3. «Asalari bilan pashsha».

B.

1. «Sholg'om».
2. «Asalari bilan pashsha».
3. «Bo'g'irsoq».

D.

1. «Asalari bilan pashsha».
2. «Sholg'om».
3. «Bo'g'irsoq».



II. Topshiriq.

O'tgan darsda ishlangan «Bobomning bog'i» rasmini taqdimot qiling.

MUNDARIJA

I CHORAK

Rang va tuslar.....	5
Mevalar rasmini ishlash.....	10
Manzara rasmini ishlash.....	15
Ustozlar bayramiga tabriknoma eskizini ishlash.....	20
«Bo‘g‘irsoq» ertagi asosida haykal yasash.....	23
Xalq amaliy san‘ati	27
«Kuz keldi» mavzusida rasm ishlash	32
Oraliq nazorat darsi.....	37

II CHORAK

Baliq haykalchasini yasash.....	40
«Kuzgi ishlar» mavzusida rasm ishlash.....	43
Yo‘lsimon shaklida naqsh ishlash.....	46
«Tulki bilan bo‘ri» ertagi asosida haykal yasash....	51
«Archa bayrami» mavzusida rasm ishlash.....	55
Oraliq nazorat darsi.....	61

III CHORAK

«Qish manzarasi» mavzusida rasm ishlash.....	64
Yuk mashinasi rasmini ishlash.....	67
Qush rasmini ishlash.....	71
Ot (tuya, mushuk, fil kabi hayvonlar) haykalini yasash.....	75



Naqsh namunalaridan nusxa ko'chirish.....	79
Doira shaklidagi naqsh kompozitsiyasini chizish....	84
8-mart bayramiga tabriknoma eskizini ishlash.....	87
«Navro'z – bahor bayrami» mavzusida rasm ishlash.....	90
«Mening maktabim» mavzusida rasm ishlash.....	95
Oraliq nazorat darsi.....	99

IV CHORAK

Daraxt bargi rasmini ishlash.....	102
«Sholg'om» ertagi asosida haykalchalar yasash...105	
Tuya rasmini ishlash.....	109
«Bobomning bog'i» mavzusida rasm ishlash.....	113
«Uch jo'ja va o'rdakcha» she'ri asosida haykalchalar yasash.....	119
Yakuniy nazorat darsi.....	122

**MUYASSAR ISOQOVA, RAHIM HASANOV,
BAHODIR HAYDAROV, ASQARALI SULAYMANOV,
SAODAT JUMANIYAZOVA, ABDUMANNOB ROZIQOV**

TASVIRIY SAN'AT

*Umumiy o'рта ta'lim maktablarining
2-sinfi uchun darslik*

Qayta ishlangan va to'ldirilgan beshinchi nashri

Muharrirlar **Umida Sodiq qizi,
Dilafro'z Choriyeva**

Rassom **Aziz Safarov**

Badiiy muharrirlar **Azamat Yuldashev,
Nasiba Yoqubova**

Texnik muharrir **Yelena Tolochko**

Musahhah **Dilafro'z Choriyeva**

Matn teruvchi **Gulchehra Azizova**

Litsenziya raqami AI № 163. 09.11.2009. Bosishga 2018-yil 16-aprelda ruxsat etildi. Bichimi 70×90^{1/16}. Ofset qog'ozi. «Pragmatica» garniturasida. Kegli 16, 14. Shartli bosma tabog'i 9,36. Nashr tabog'i 10,62. Adadi 490375 nusxa. Shartnoma № 34-2018. Buyurtma № 221.

O'zbekiston Matbuot va axborot agentligining Cho'lpon nomidagi nashriyot-matbaa ijodiy uyida tayyorlandi. 100011, Toshkent, Navoiy ko'chasi, 30. Telefon: (371) 244-10-45. Faks: (371) 244-58-55.

O'zbekiston Matbuot va axborot agentligining G'afur G'ulom nomidagi nashriyot-matbaa ijodiy uyi bosmaxonasida chop etildi. 100128, Toshkent, Labzak ko'chasi, 86.

T 25 **Tasviriy san'at** [Matn]: 2-sinf uchun darslik. /M. Isoqova [va bosh.] – Qayta ishlangan va to'ldirilgan beshinchi nashri. – T.: Cho'lpon nomidagi NMIU, 2018 – 128 b.
ISBN 978-9943-05-820-0

**UO'K 372.874(075)
KBK 85.15ya71**

Ijaraga berilgan darslik holatini ko'rsatuvchi jadval

T.r.	O'quvchining ismi, familiyasi	O'quv yili	Darslikning olingandagi holati	Sinf rahbarining imzosi	Darslikning topshiril-gandagi holati	Sinf rahbarining imzosi
1.						
2.						
3.						
4.						
5.						
6.						

Darslik ijaraga berilib, o'quv yili yakunida qaytarib olinganda yuqoridagi jadval sinf rahbari tomonidan quyidagi baholash mezonlariga asosan to'ldiriladi:

Yangi	Darslikning birinchi marotaba foydalanishga berilgandagi holati.
Yaxshi	Muqova butun, darslikning asosiy qismidan ajralmagan. Barcha varaqlari mavjud, yirtilmagan, ko'chmagan, betlarida yozuv va chiziqalar yo'q.
Qoniqarli	Muqova ezilgan, birmuncha chizilib, chetlari yedirilgan, darslikning asosiy qismidan ajralish holati bor, foydalanuvchi tomonidan qoniqarli ta'mirlangan. Ko'chgan varaqlari qayta ta'mirlangan, ayrim betlariga chizilgan.
Qoniqarsiz	Muqovaga chizilgan, yirtilgan, asosiy qismidan ajralgan yoki butunlay yo'q, qoniqarsiz ta'mirlangan. Betlari yirtilgan, varaqlari yetishmaydi, chizib, bo'yab tashlangan. Darslikni tiklab bo'lmaydi.