

RAHYM HASANOW

ŞEKILLENDİRİŞ SUNGATY

1-nji SYNP ÜÇIN DERSLIK

Gaýtdan işlenen 17-nji neşir

Özbekistan Respublikasynyň Halk bilimi ministrligi
tarapyndan neşire hödürlenlen

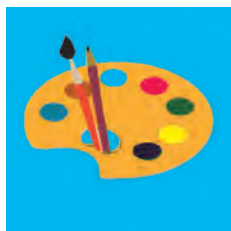

Gafur Gulam adyndaky neşirýat-çaphana döredijilik öýi
Daşkent – 2019

UO'K 741 (075)
KBK 74.268.51
H 12

Jogapkär redaktor

Asgarali Suleýmanow – pedagogika ylymlarynyň kandidaty

Syn ýazanlar:

R. Hudaýberganow – Kemaliddin Behzad adyndaky Milli suratkeşlik we dizaýn institutynyň professory;

G. Zulhaýdarowa – Respublikan Tälim merkeziniň metodisti;

T. Mansurow – Daşkent welaýatynyň Çinaz tümenindäki 40-njy mekdebiň mugallymy.

Z. Haşimowa – Daşkent şäheriniň Almazar tümenindäki 16-njy mekdebiň mugallymy.



– ýumuşlar.



– öý işi.



– ders gutardy.

**Respublikanyň ýörite kitap gaznasynyň
serişdeleriniň hasabyndan çap edildi.**

Hasanow R.

Şkillendiriş sungaty. 1-nji synp üçin derslik. Gaýtadan işlenen 17-nji neşir. – D.: Gafur Gulam adyndaky neşirýat-çaphana döredijilik öýi, 2019. – 56 s.

UO'K 741 (075)
KBK 74.268.51

© Rahim Hasanow
© Gafur Gulam adyndaky
neşirýat-çaphana döre-
dijilik öýi, 2019

ISBN 978-9943-5549-5-5

ŞEKILLENDİRİŞ SUNGATYNYŇ GÖRNÜŞLERİ

Žiwopis



R. Hudaýbergenow. **Sijjakda güýz**



Pawel Benkow. **Dutarçy gyz**



Bagtyýar Olimhanow. **Natýurmort**

Heykeltaraşlyk



R. Mirtojýew. **Mürze Ulugbek**

Grafika



Wladimir Parşin.
Salam



Syýahat



Kutlug Başarow.
Kemandan ok atmak



SURATKEŞIŇ IŞ GURALLARY

Galam we çotgalar

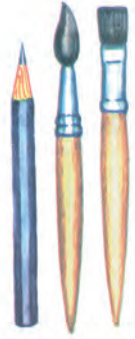

Akwarel reňkler



Suw gaby



Bozguç

Reňkli galamlar



Palitra



Guaş boýaglary

Iş ýerini guramak



ÇYZYKLAR WE ŞEKILLER

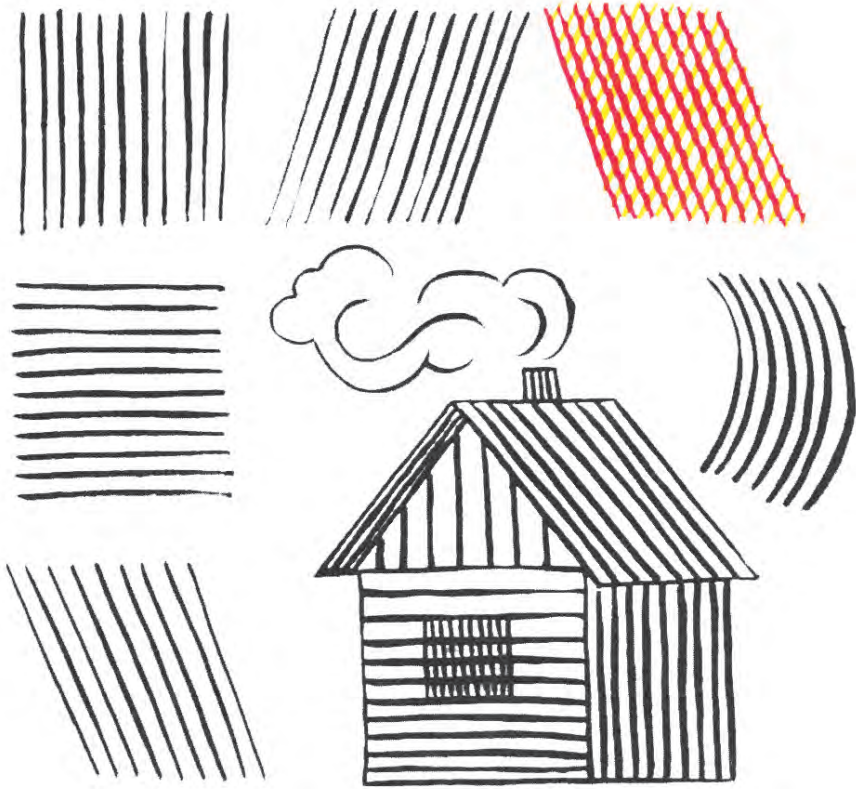

Bu suratlar şekillerden düzülen.

Teswirler we şekiller

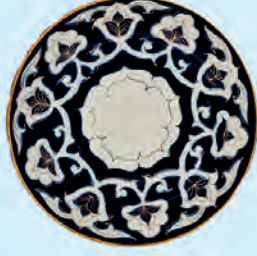

Tegelek

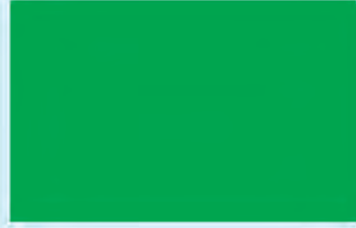

Dörtburçluk



Kwadrat



Üçburçluk

Teswirler we şekiller



Konus

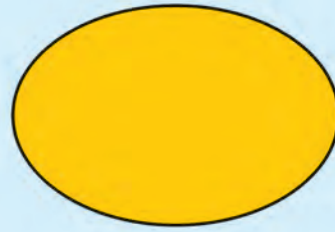

Owal

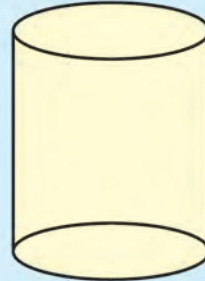
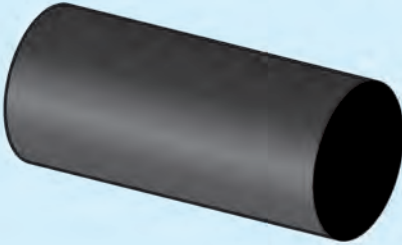

Silindr

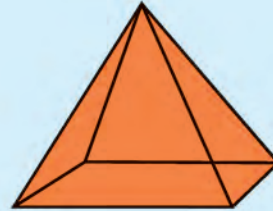

Piramida



Şekilleriň atlaryny öwrenýäris.

Tolkun şekilli çizyklar we şekiller

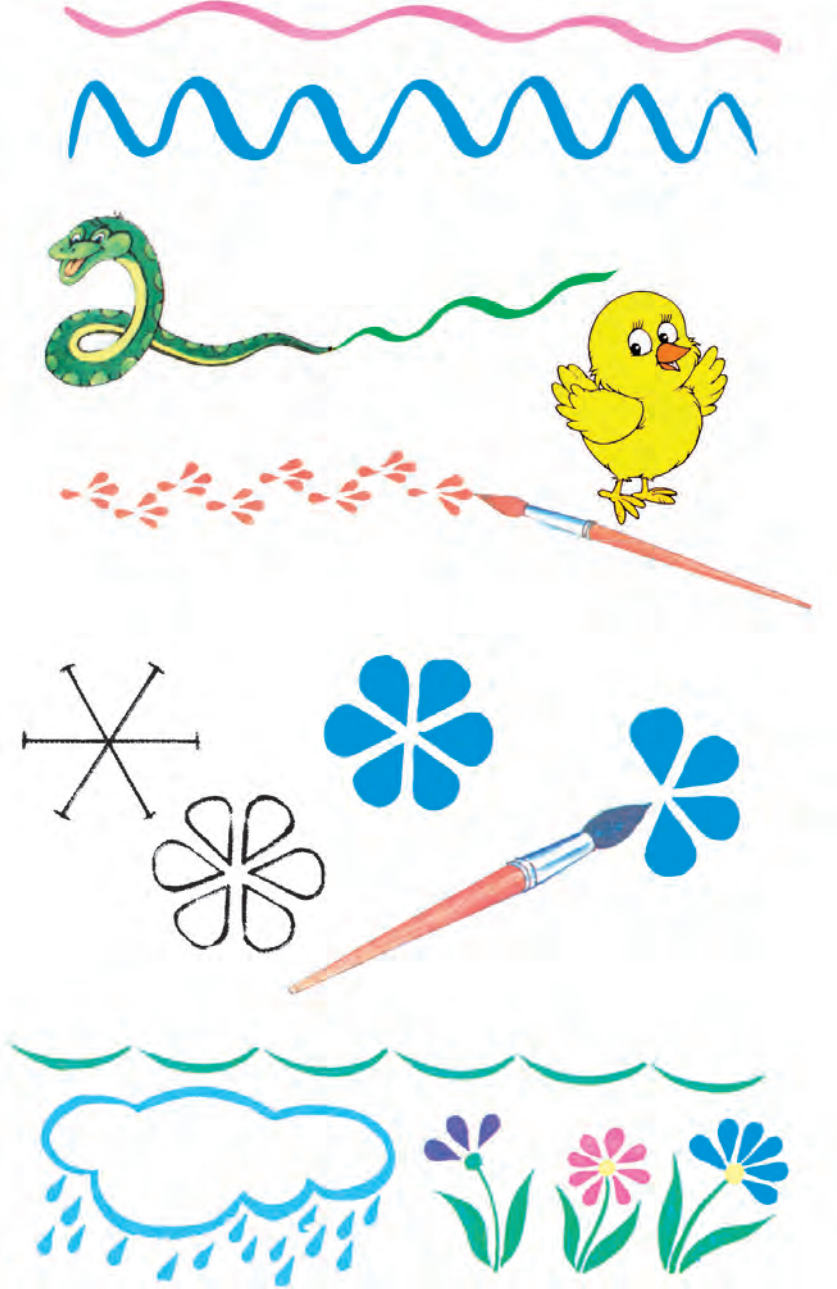

BOÝAGLAR WE REŇKLER

Akwarel we guaş boýaglar



Reňkler



Sary



Ak



Gyzyl



Gara



Mämişi



Kül reňk



Gök

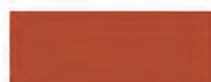

Gyrmyzy



Ýaşyl



Melewşe



Esasy reňkler

Gyzyl

Sary



Esasy reňklerden başga reňkleri almak

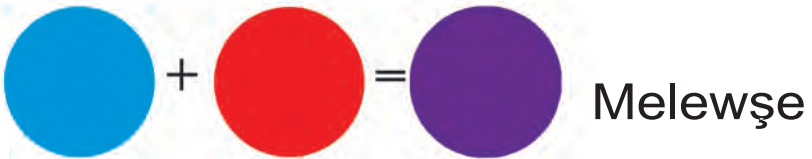
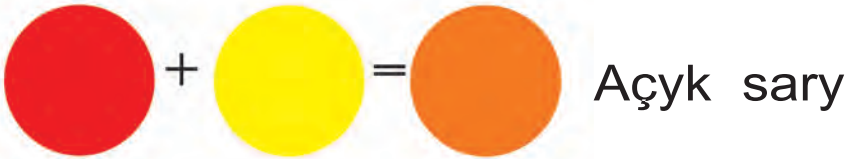
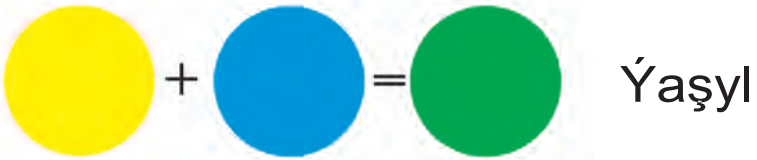

BAÝDAJYGYŇ SURATYNY ÇEKMEK

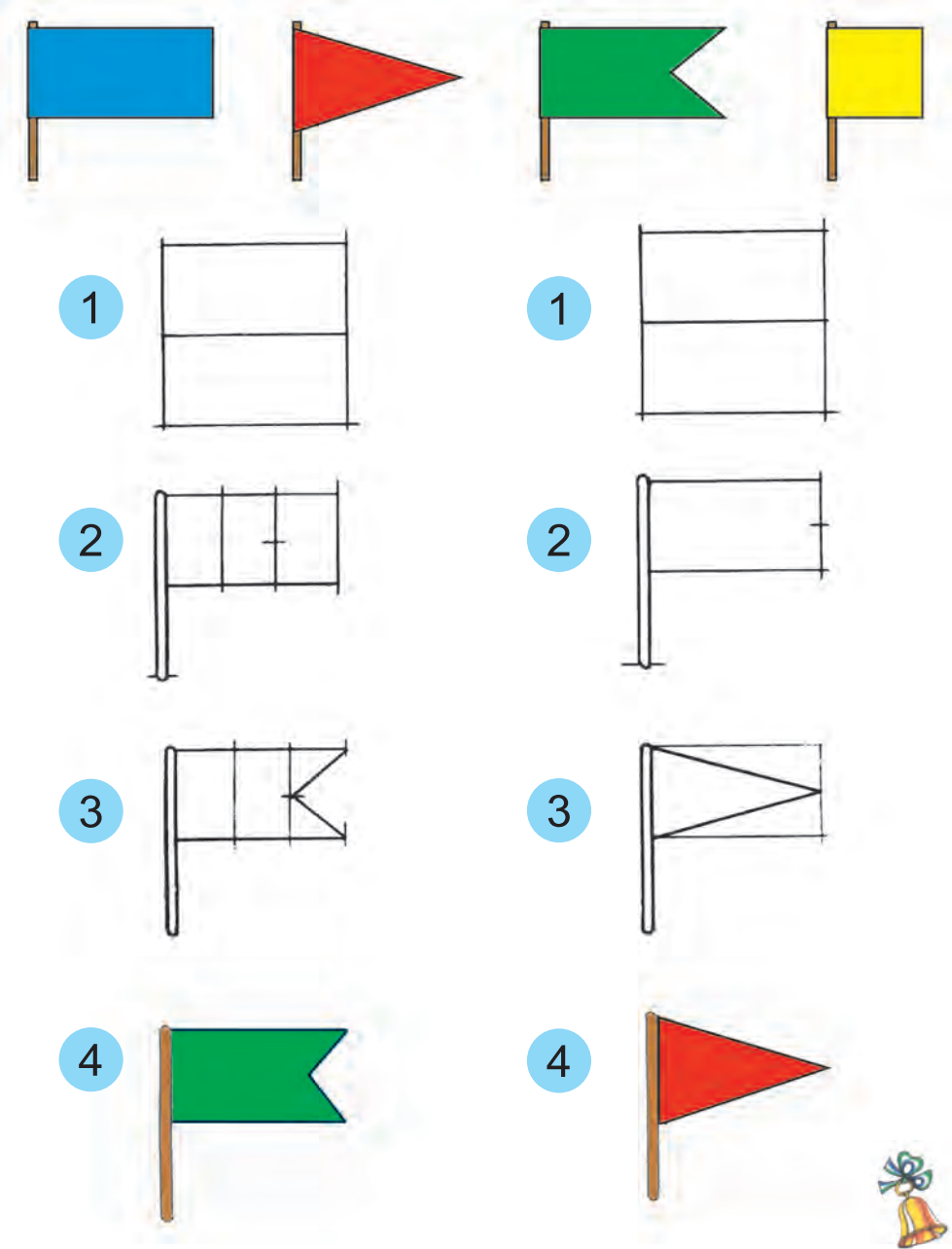

SAGADYŇ SURATYNY ÇEKMEK

Sagatlar her hili şekilde bolýar.



Sagadyň suraty şeýle çekilýär.

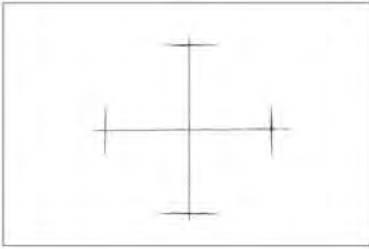

1

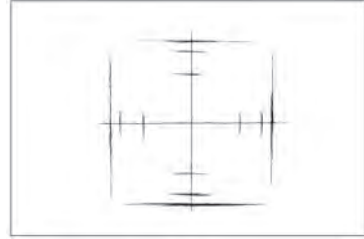

2

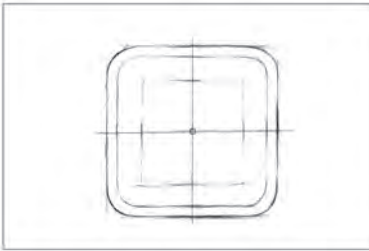

3

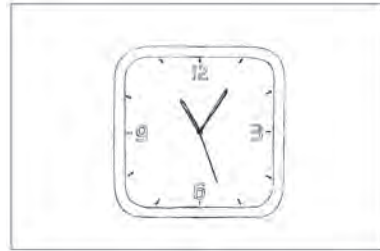

4



GÜZ PASLYNY AŇMAK



N. Karahan. **Altyn güz**



Abduwali Möminow. **Peýzaž**



W. Polenow. **Altyn güýž**

DARAGTYŇ ÝAPRAKLARYNYŇ SURATYNY ÇEKMEK



Ýapraklaryň şekilleri we reňkleri
her hili bolýar.

Ýapragyň suraty şeýle çekilýär:

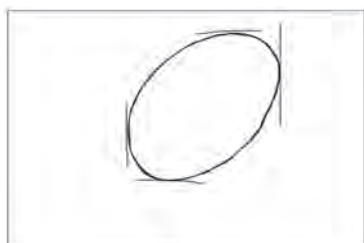

1

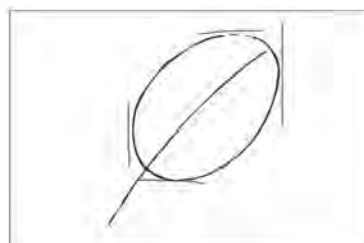

2

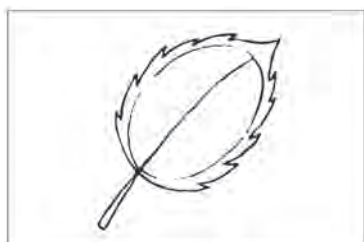

3



4

Ýapragyň suraty şeýle reňklenýär:

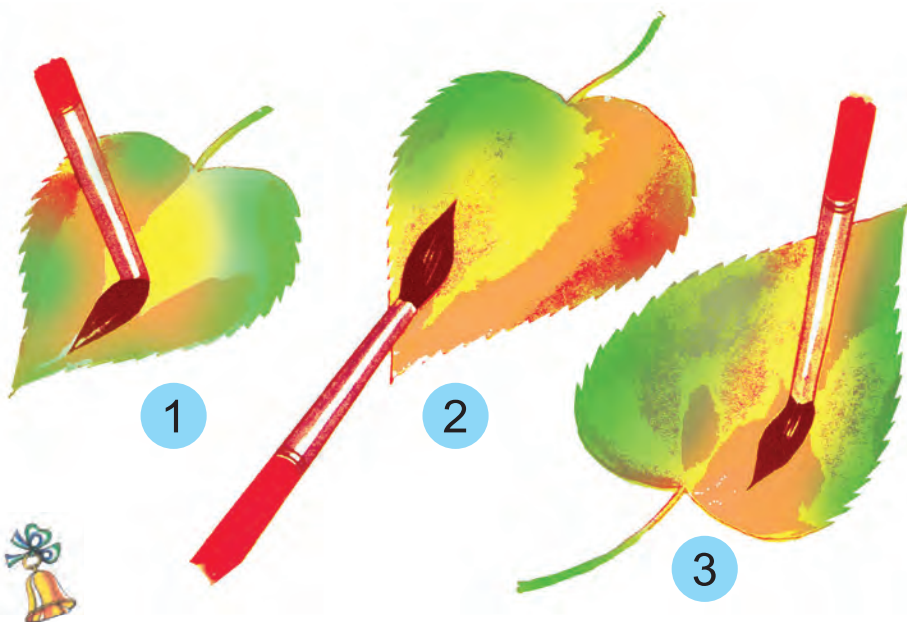

1

2

3

ALMANYŇ WE HURMANYŇ SURATYNY ÇEKMEK



Alma



Hurma

Almanyň suraty şeýle çekilýär we reňklenýär

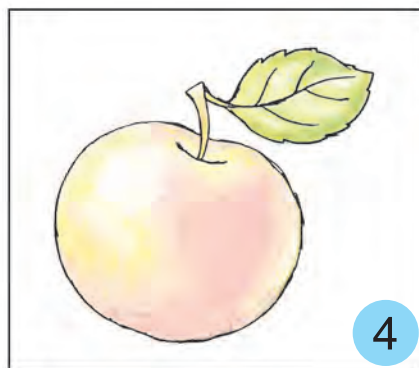
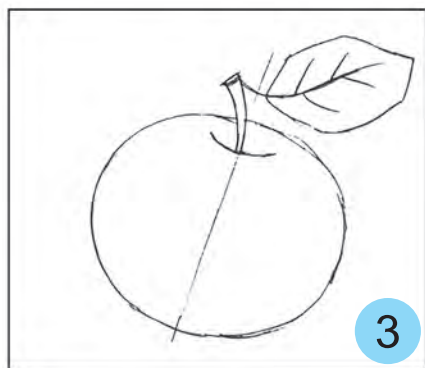
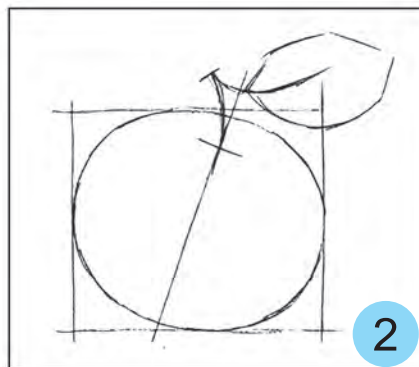
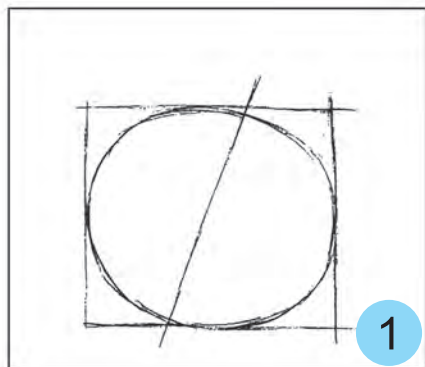

«ALTYN GÜYZ» TEMASYNYDA SURAT ÇEKMEK



Irki güyz



Orta güyz



Giçki güyz



ŞEKILLENDİRİŞ SUNGATYND A HEÝKEL IŞLEMEGIÑ SYRLARY





Georgiy Ulko. **Ussa Umarkul Jorakulow**



Ussanyň işlerinden nusgalar.



Hünärmentçilik işlerinden nusgalar

Oýnawaç heýkeljik aşakdaky ýaly ýasalýar:



AKWARIUMDAKY BALYKLARYŇ SURATYNY ÇEKMEK



Balyklar gurluşy we reňki taýdan
dürlüçe bolýarlar.

Balygyň suraty şeýle çekilýär:

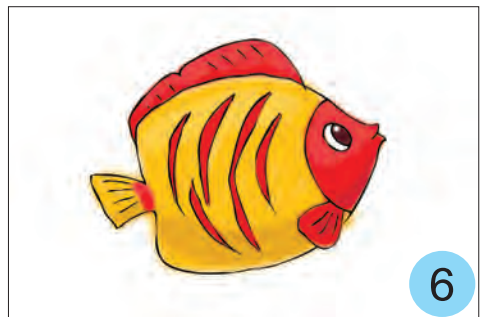
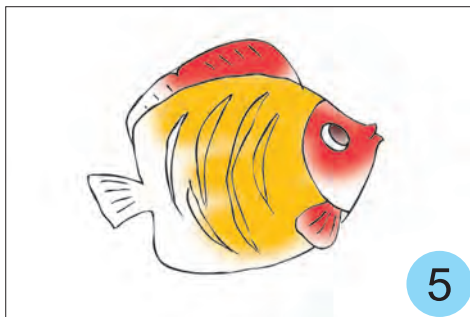
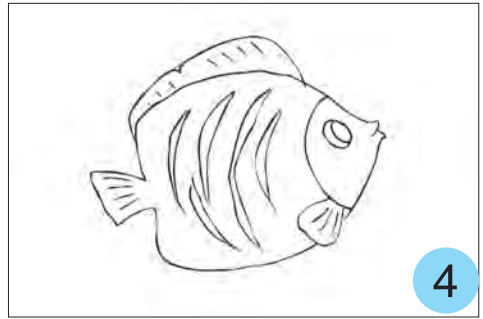
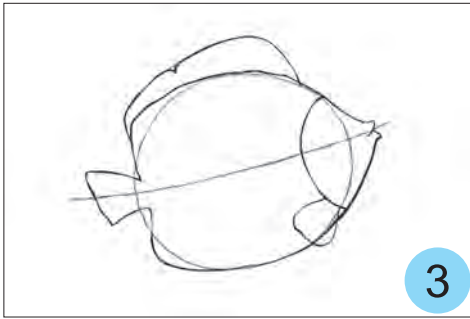
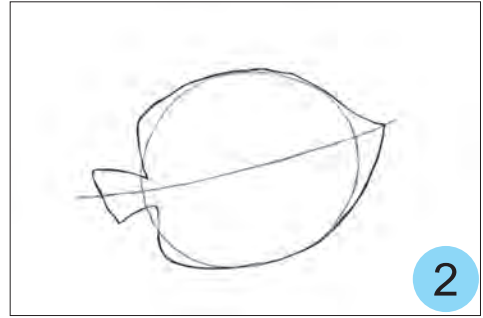
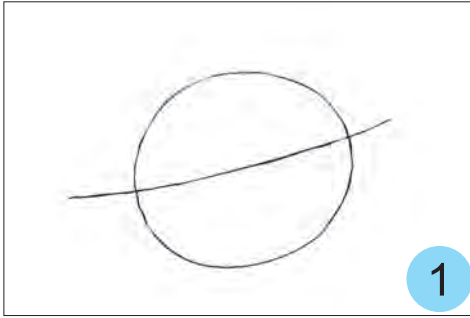

«IKI GEÇI» ERTEKISI ESASYNDA HEÝKEL IŞLEMEK



Geçiniň heýkeli şeýle ýasalýar:

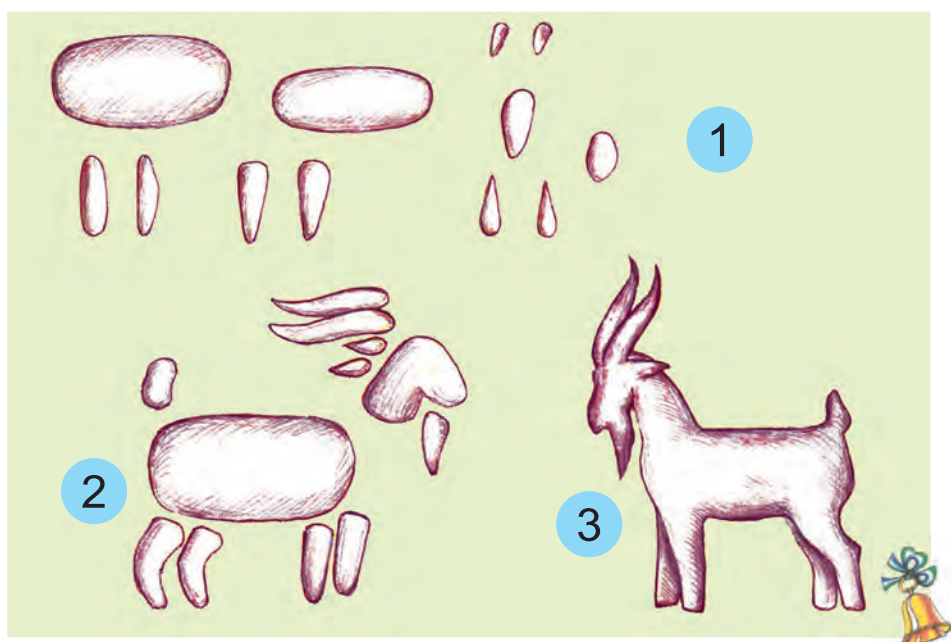

AWTOMAŞYNYŇ SURATYNY ÇEKMEK



Maşynlaryň şekillerine we reňklerine
üns beriň, atlaryny aýdyň.

Awtomaşynyň suraty aşakdaky ýaly çekilýär we reňklenýär:

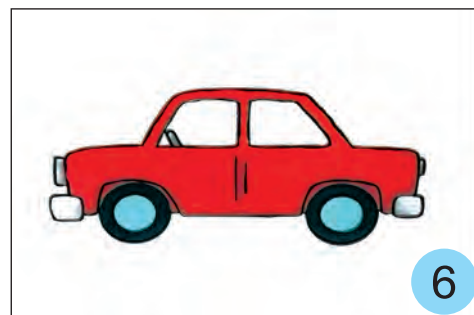
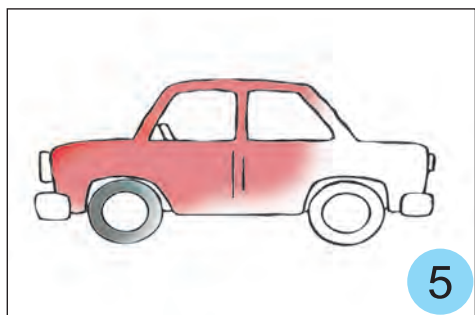
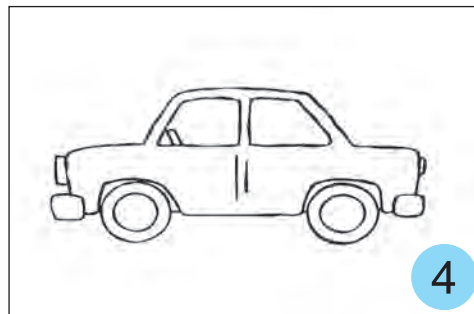
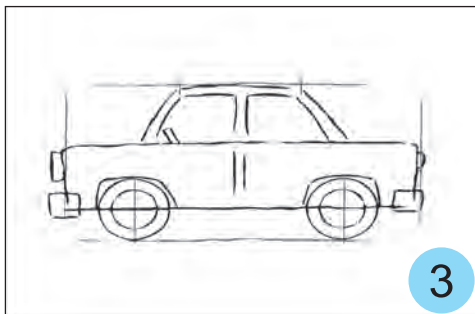
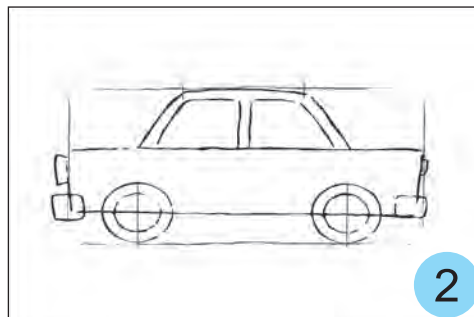
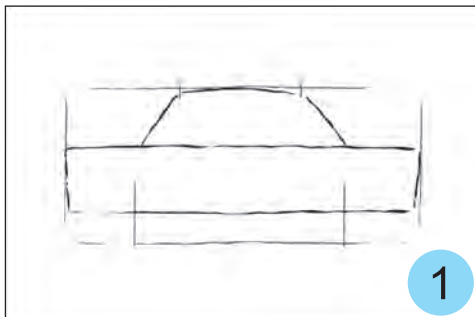

Indi awtomaşynyň suratyny çekiň.

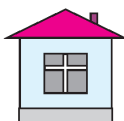

Synpda başlan işiňizi ahyryna ýetiriň.



GYŞ PASLYNY AŇMAK

Aşakdaky suratda gyš pasly
şekillendirilen.



I.I.Şişkin. **Gyş**



Rustam Hudaýberganow. **Gyş**

Ýokardaky suratda gyş paslynyň şekillendirilendigini nädip bilmek mümkin? Suratda nämeler şekillendirilen?



Gyşyň görnüşini syn ediň.



«KÜMÜŞ GYŞ» TEMASYNYDA SURAT ÇEKMEK



Gözegçilikleriňiz esasynda gy-
şyň görnüşiniň suratyny çekiň.



Synpda başlan işiňizi ahyryna
ýetiriň.



KÜRRÄNIŇ HEÝKELJIGINI IŞLEMEK



Bu heýkeljikler laýdan ýasalan.

Siz öň taýçanagyň heýkeljigini işläpdiniz. Ony nähili işläň bolsaňyz kürräniň heýkeljigini hem şeýle işläň.

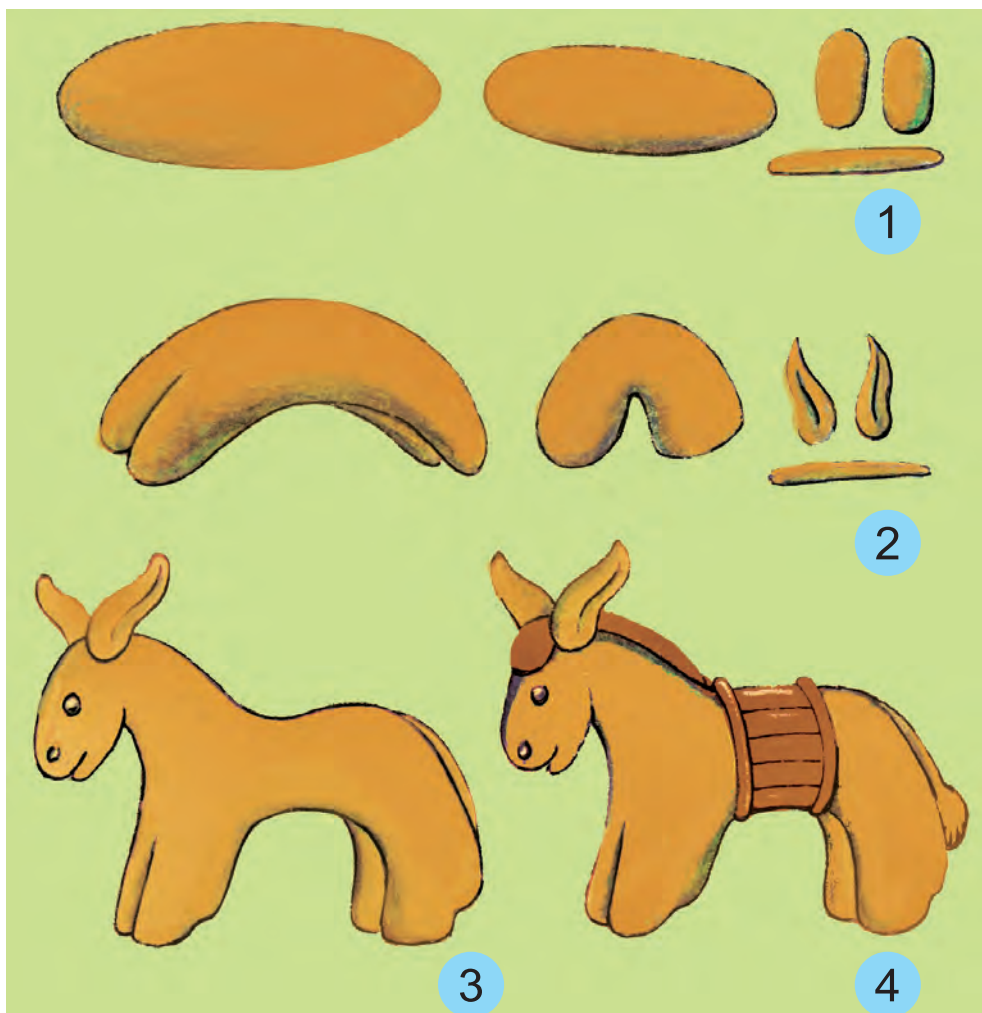

Kürräniň heýkeljigini laýdan ýa-da plastilinden ýasamaga girişiň.

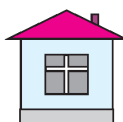

Synpda başlan işiňizi ahyryna ýetiriň.



ÝELKENLI GAÝYJYK TEMASYNDA SURAT ÇEKMEK



Gaýyjygyň suraty aşakdaky tertipde çekilýär we reňklenýär:

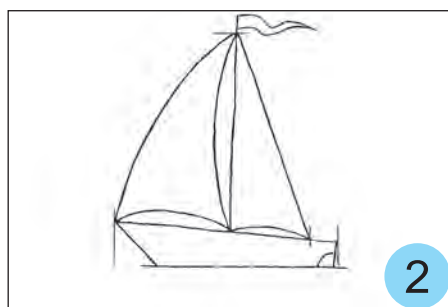
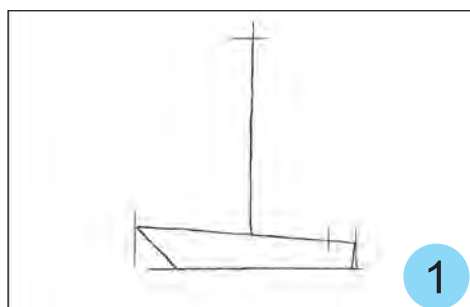

Siz hem ýelkenli gaýyjygyň suratyny çekiň.



«ÜÇ TILKI» ERTEKISI ESASYNDA SURAT İŞLEMEK

Ertekiniň mazmuny aşakdaky ýaly:

Kaşga lakamly towşan eşegine münüp, kürresini yzyna salyp tokaýa tarap ugraýar. Dostlary tokaýda mekir tilkileriň bardygyny aýdyp, ony duýdurýarlar. Kaşga olaryň gepine girmeyär. Tokaýda ol ilki ata tilkä aldanyp kürrasini, soňra ene tilkä eşegini ogurladýar.



Aldanan towşan kölüň boýunda aglap oturan tilkä duşýar we ondan näme üçin aglaýandygyny sorayar.

Tilkijik gapjygynyň suwa gaçandygyny, eger alyp berse ýüz teňňesini oňa berjekdigini aýdýar. Towşan ýüz teňňä eşek satyn almagyň hyýalyňa gidip geýimlerini çykaryp özüni suwa oklaýar. Pursatdan peýalanan tilkijik onuň geýimlerini alyp gidýar.

Kaşga gapjygy tapman suwdan çyksa, geyimleri ýok eken. Üç tilkä aldanandygyny duýan towşan tokaýa ýalňyz gitmeýän bolýar.



Towşanyň we tilkiniň şekilleri aşakdaky yzygiderlikde işlenýär:

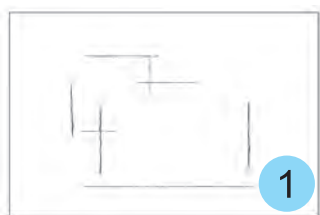

1

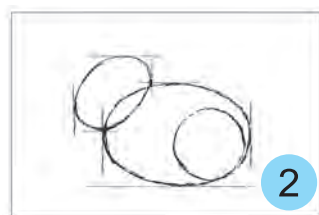

2



3



5



4



1



2

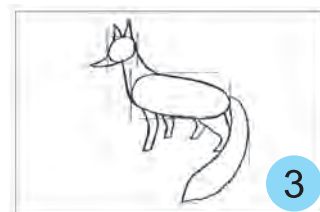

3

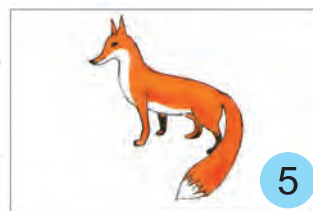

5



4



Ertekiniň mazmuny esasynda surat çekiň.

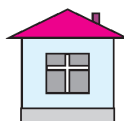

Synpda başlan işiňizi ahyryna ýetiriň.



PILIŇ HEÝKELJIGINI IŞLEMEK

Siz öň dürli heýkeljikleri ýasapdyňyz. Olary nähili ýasan bolsaňyz, piliň heýkeljigini-de şol yzygiderlikde aşakdaky ýaly ýerine ýetiriň:

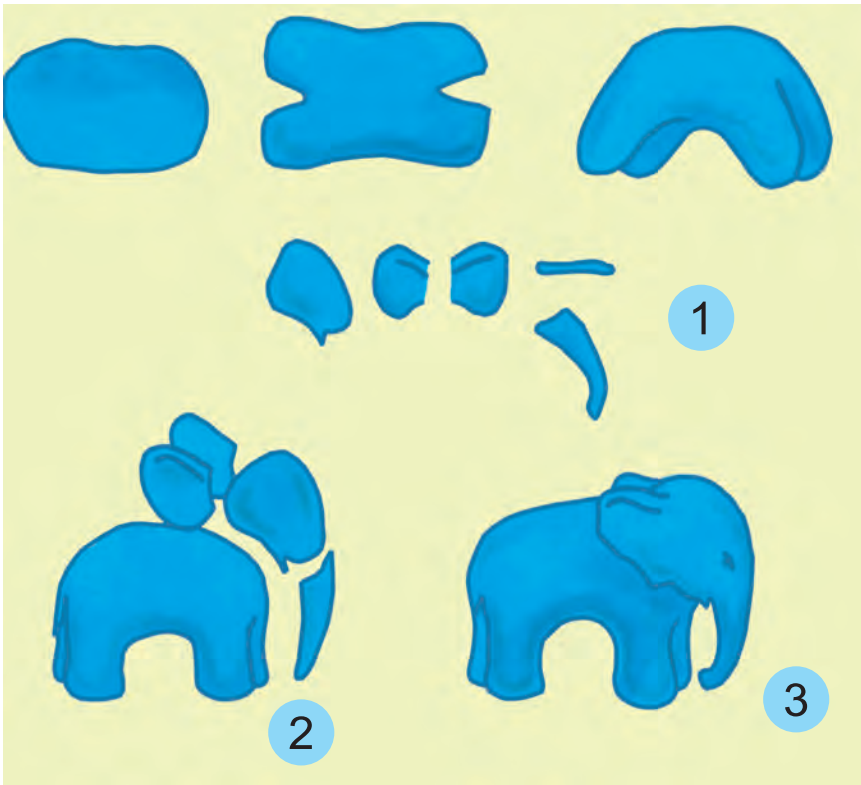

Piliň heýkeljigini laýdan ýa-da plastilinden ýasaň.



Başga haýsy-da bolsa bir haýwanyň heýkeljigini ýasaň.



SAMOLÝOTYŇ SURATYNY ÇEKMEK



Samolýotlar her hili bolýar.

1



2

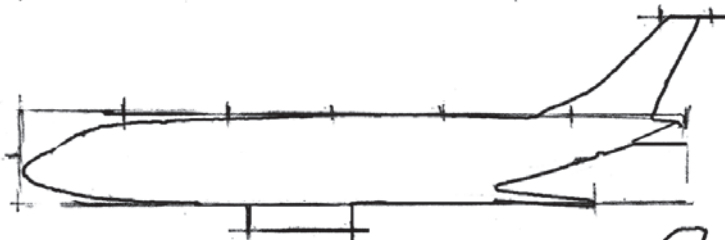

3

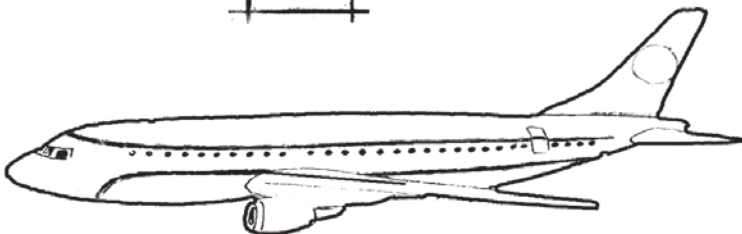

4

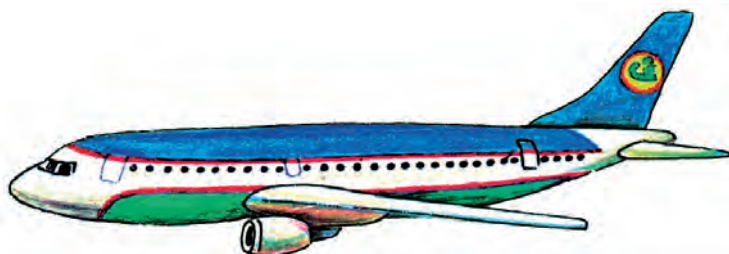

Samolýotyň suratyny ýokarda görkezilen çyzgylar boýunça çekiň.



Synpda başlan işiňizi ahyryna ýetiriň.



BAHAR PASLYNY AŇMAK



Isaak Lewitan. **Bahar**



Oral Tansykbayew. **Dagda**

Bahar paslynyň görnüşlerini
synlaň.



«ÜLKÄMIZDE BAHAR» TEMASYNDA SURAT ÇEKMEK



Rustam Hudaýberganow.
Baglarda bahar

Esere gowy üns beriň, onda näme-
leriň suratlandyrylandygyny aýdyp be-
riň.

Tebigatyň baharky görnüşi aşakdaky zygiderlikde çekilýär:

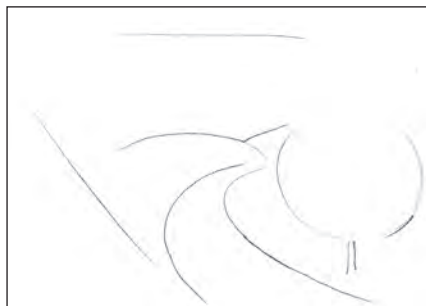

1

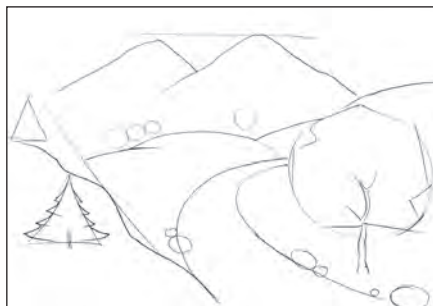

2



3

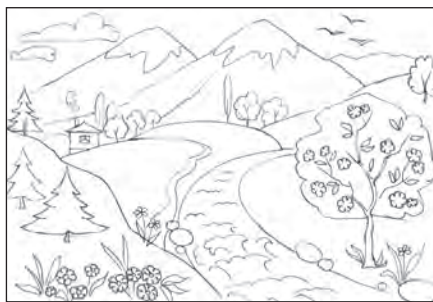

4



Tebigatyň baharky görnüşiniň suratyny çekiň.



Synpda işlenen tebigatyň baharky görnüşini dowam etdiriň we reňkläň.



HOWA ŞARYNYŇ SURATYNY ÇEKMEK



1

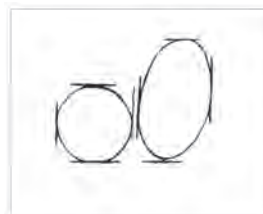

2

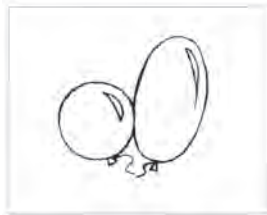

3



4



Ýokardaky howa şarlaryny çekiň we reňkläň.



Başga şekildäki we reňkdäki şarlaryň suratyny çekiň.



GÜLLERİŇ SURATYNY ÇEKMEK

Baharda açylan güller özleriniň şekilleri, reňkleri bilen adamlary haýran galdyrýar. Ylaýta-da, çigillem, benewşe, tozga we bägüller adamlaryň ünsüni özüne çekýär.



Gafur Abdurahmanow.
Gyzyl kerneýgülli natýurmort



Leýla Salimjanowa. **Güller**



Ýaşytdaşlaryňzyň çeken suraty

Suratda nähili gülleriň we nämeleriň şekillendirilendigini hem-de ulanylan reňkler barada aýdyp beriň.

Aşakda berlen tozga gülüni oňatja synlaň. Onuň boýy, ini, güli, ýapragy-nyň şekili we reňkini anyklaň.



Tozga gülüniň suraty aşakdaky ýaly çekilýär:

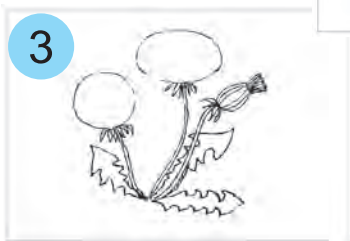
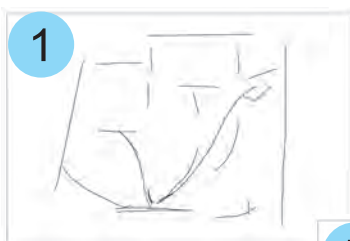

Tozga
çekiň.

gülüniň

suratyny



KEBELEKLERIŇ SURATYNY ÇEKMEK

Siz dürli reňkli kebelekleriň gülden güle gonup uçuşyny köp görensiňiz. Kebelekler her hili ululykda we reňkde bolýarlar.



Kebelegiň suraty aşakdaky zygyderlikde çekilýär:

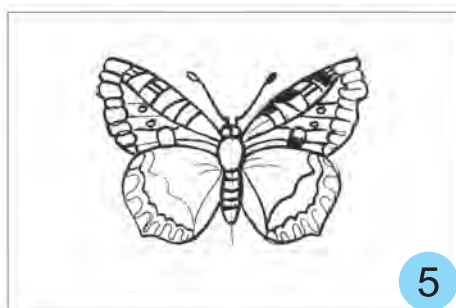
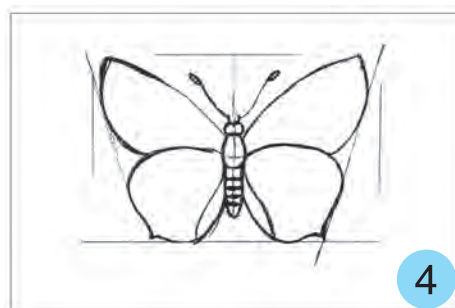
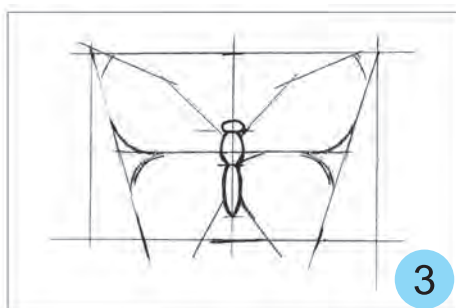
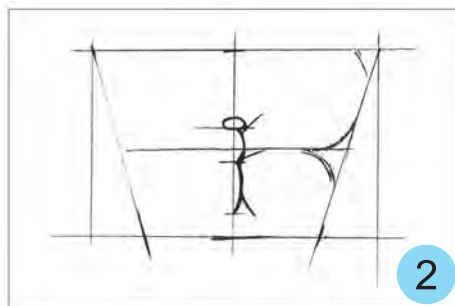
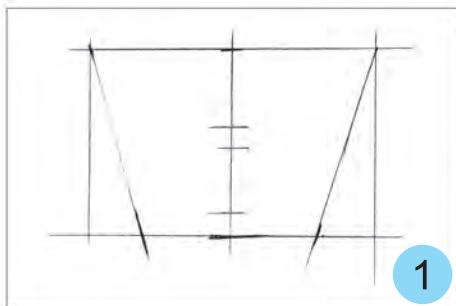

Kebelekleriň suratynyň çekiliş
zygyderligine üns beriň we onuň
suratyny çekiň.



Özüňiziň halan kebelegiňi-
ziň suratyny çekiň we reňk-
läň.



TOTUGUŞUŇ SURATYNY IŞLEMEK

Totuguşlaryň dünýäde gaty köp görnüşleri bar. Olar uly-kiçi, dürli reňkde, örän owadan bolýarlar.

Suratdaky totuguşlary gowy gözden geçiriň, olaryň gurluşynyň, şekliniň, uly-kiçiliginiň, reňkiniň nähilidigini aýdyp beriň.



Indi surat çekmäge girişmek bolar. Ilki totuguşuň suratyny kagyzyň haýsy ýerine çekjekdigiňizi we onuň uly-kiçiliginiň nähili bolmalydygyny bellik ediň. Totuguşy islän reňkiňize boýap bilersiňiz.

Totuguşuň suraty aşakdaky zygiderlikde çekilýär:

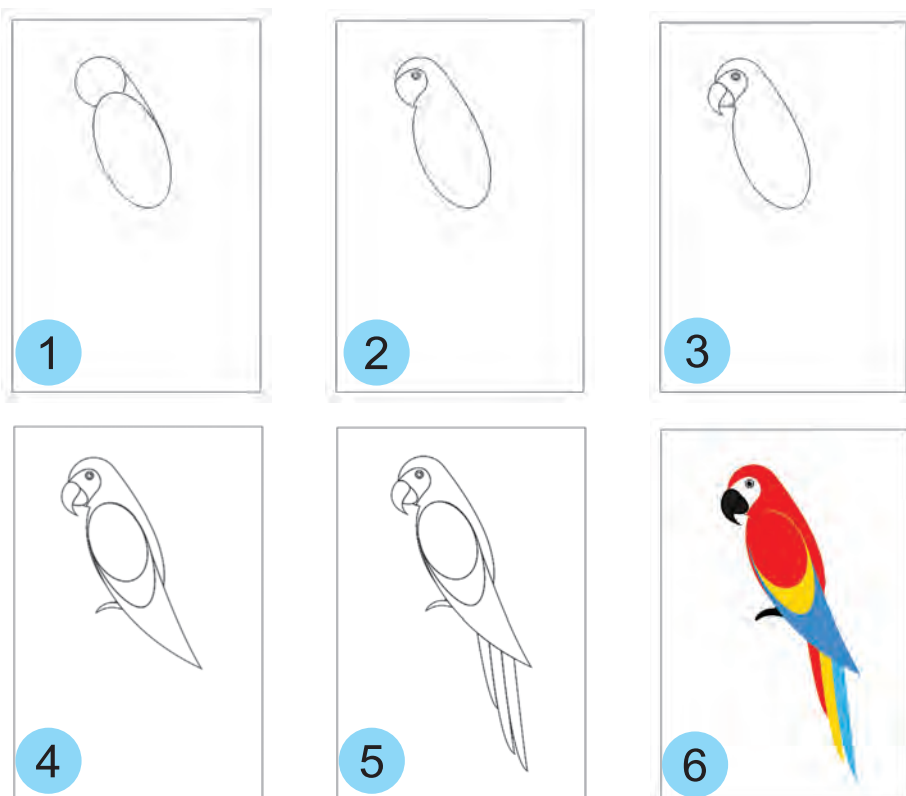

Siz hem totuguşuň suratyny çekiň.



1. Özünüzüň bilýän başga guşuňyzyň suratyny çekiň we ony reňkläň.

2. Indiki derse ýylyň dowamynda çekilen iň gowy suratlaryňyzy we heýkelleriňizi sergi üçin alyp geliň.



MAZMUNY

Şekillendiriş sungatynyň görnüşleri	3
Suratkeşiň iş gurallary	7
Çyzyklar we şekiller	9
Boýaglar we reňkler	13
Baýdajygyň suratyny çekmek	15
Sagadyň suratyny çekmek	16
Güýz paslyny aňmak	17
Daragtyň ýapraklarynyň suratyny çekmek	19
Almanyň we hurmanyň suratyny çekmek	21
«Altyn güýz» temasynda surat çekmek	23
Şekillendiriş sungatynda heýkel işlemegiň syrly ..	24
Akwariumdaky balyklaryň suratyny çekmek.....	27
«Iki geçi» ertekisi esasynda heýkel işlemek	29
Awtomaşynyň suratyny çekmek	30
Gyş paslyny aňmak	32
«Kümüş gyş» temasynda surat çekmek	34
Kürräniň heýkeljiini işlemek	35
Ýelkenli gaýyjyk temasynda surat çekmek	37
«Üç tilki» ertekisi esasynda surat çekmek	38
Piliň heýkeljigini işlemek	41
Samolýotyň suratyny çekmek	42
Bahar paslyny aňmak	44
«Ülkämizde bahar» temasynda surat çekmek	45
Howa şarynyň suratyny çekmek.....	47
Gülleriň suratyny çekmek.....	48
Kebelegiň suratyny çekmek.....	51
Totuguşuň suratyny işlemek.....	53

Rahim Hasanov

TASVIRIY SAN'AT

(Turkman tilida)

1-sinf uchun darslik

Qayta ishlangan 17-nashri

Terjime eden *K. Hallyýew*
Redaktor *J. Metýakubow*
Çeper redaktor *Ş. Mirfayazow*
Tehredaktor *H. Hasanowa*
Korrektor *J. Metýakubow*
Kompýuterde sahaplaýjy *H. Şaripowa*

Neşirýat lisenziýasy AI № 290. 04.11.2016.

Çap etmäge 2019-njy ýylyň 18-nji martda rugsat egildi. Ölçeği 70x100^{1/16}. Kegli 18 şponly. Arial garniturası. Ofset çap ediliş usuly.

Şertli çap listi 4,55. Neşir listi 4,8.

1076 nusgada çap edildi. Buýurma № 86.

Özbeğistanyň Respublikasynyň Prezidentiniň Administrasiýasynyň ýanyndaky Habar we köpçülikleýin kommunikasiýlar agentliginiň Gafur Gulam neşirýat-çaphana döredijilik öýünde çap edildi.

100128. Daşkent. Labzak köçesi, 86.

www.gglit.uz

info@gglit.uz